

\$ 18 cop. 1

TM 9-227

WAR DEPARTMENT

TECHNICAL MANUAL



**20-MM AUTOMATIC GUN M1 AND
20-MM AIRCRAFT AUTOMATIC GUN AN-M2**

1 JUNE 1943

CANCELLED
LIBRARY

APR 19 1946

U. S. PATENT OFFICE

20-MM AUTOMATIC GUN M1 AND 20-MM AIRCRAFT AUTOMATIC GUN AN-M2

LIBRARY

Prepared under the direction of the
Chief of Ordnance

APR 19 1946

(with the cooperation of the Chief of the Bureau of Ordnance, Navy Department)

U. S. PATENT OFFICE

CONTENTS

SECTION		Paragraphs	Pages
	I. Introduction	1- 6	2- 8
	II. Description, functioning, and installation	7-13	9- 74
	III. Operation	14-19	75- 79
	IV. Disassembly and assembly.....	20-27	80-101
	V. Malfunctions and corrections.....	28-30	102-105
	VI. Cleaning and lubrication.....	31-35	106-108
	VII. Inspection	36-41	109-112
	VIII. Ammunition	42-55	113-123
	IX. Organizational spare parts and accessories	56-57	124-126
	X. Storage and shipment.....	58-60	127-129
	XI. Maintenance under unusual conditions	61-63	130-131
	XII. References	64-65	132
INDEX			133-136

*This manual supersedes TM 9-227, 19 November 1942; TB 227-4, 6 November 1942; TB 227-5, 5 May 1943; TB 227-6, 12 May 1943; Ordnance School Manual (OS) No. 9-3, 15 August 1941; and Ordnance School Manual (OS) No. 9-45, December 1942.

20-MM AUTOMATIC GUN M1 AND
20-MM AIRCRAFT AUTOMATIC GUN AN-M2

UF
523
A5
no. 207
copy

Section I

INTRODUCTION

	Paragraph
Scope	1
Characteristics	2
Model of gun used by the Navy.....	3
Models of gun used by the Army.....	4
Data	5
Precautions	6

1. SCOPE.

a. This manual is published for the information and guidance of the using arms and services. It contains information of a technical nature required by the personnel of the Army and Navy for the identification, use, care, and preservation of the 20-mm Automatic Gun M1 and 20-mm Aircraft Automatic Gun AN-M2, and of the accessories and ammunition used therewith.

b. This manual differs from TM 9-227 of 19 November 1942 as follows:

- (1) The material has been arranged to conform with gun type designations.
- (2) The table of data has been enlarged.
- (3) The material has been enlarged to cover the adapters, chargers, and electric trigger.
- (4) Instructions for the disassembly and assembly of the 20-mm feed mechanism AN-M1 have been revised and simplified.

2. CHARACTERISTICS.

a. Description.

(1) The 20-mm Automatic Gun (figs. 1 and 2) is a combination blowback and gas-operated aircraft weapon. The gun is air-cooled and has a cyclic rate of fire of 600 to 700 rounds per minute. It is designed for mounting as a fixed gun in the wing or fuselage of an airplane. It may also be mounted to fire through the hub of the propeller, and may be mounted as a flexible gun in a turret. The gun cannot be synchronized to fire between the propeller blades of an airplane.

INTRODUCTION



Figure 1 — Basic Gun — Right Side



Figure 2 — Basic Gun — Left Side

20-MM AUTOMATIC GUN M1 AND
20-MM AIRCRAFT AUTOMATIC GUN AN-M2

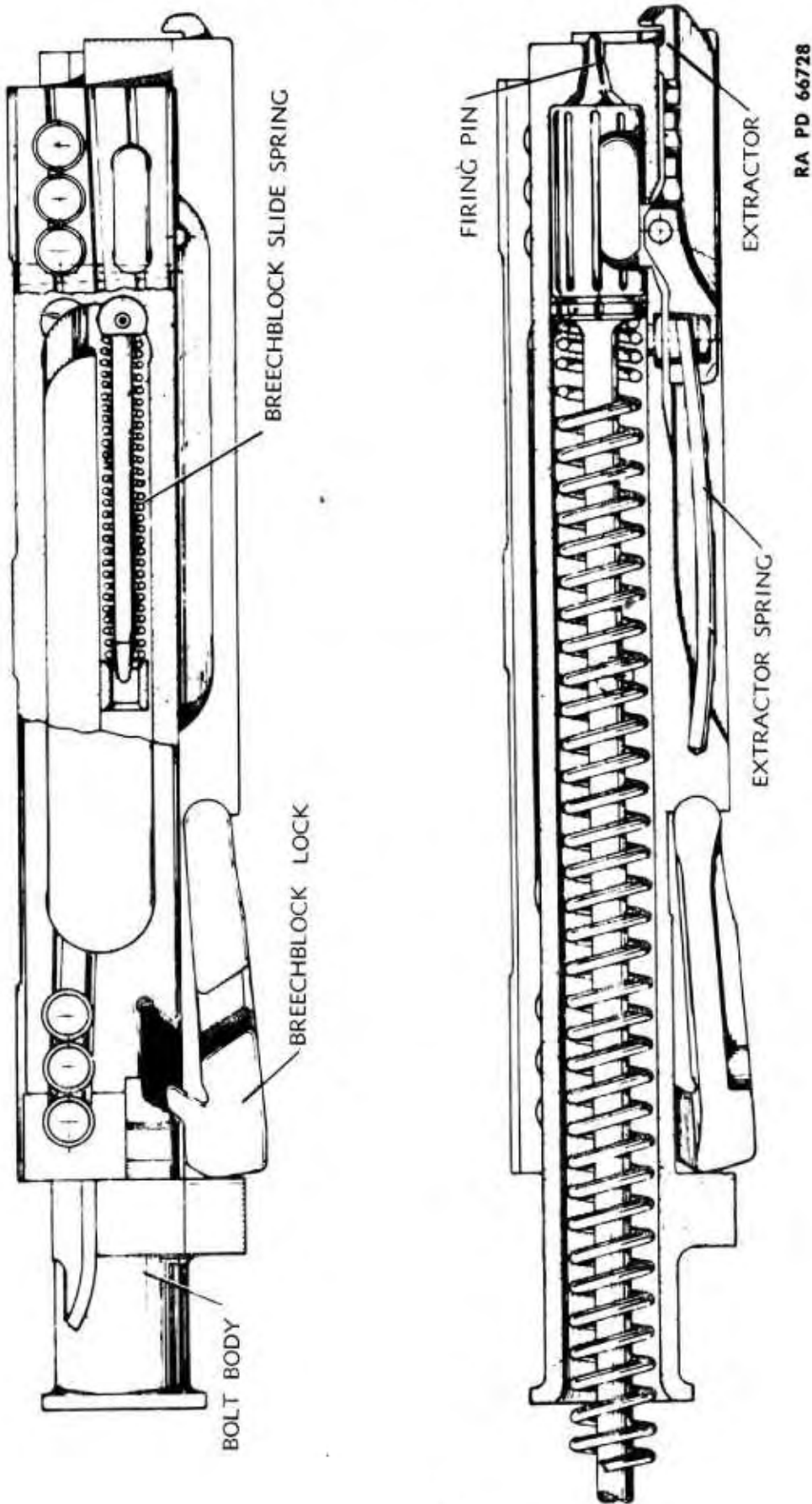

Figure 3 — Breechblock Modifications

INTRODUCTION

(2) The gun can be fed by a drum type magazine or a feed mechanism using a disintegrating link belt. The name and serial number of the gun and name of manufacturer are stamped on the top of the receiver just to the rear of the magazine slide. The serial number of the tube, name of gun, and name of manufacturer are stamped on the tube just ahead of the gas cylinder bracket. The serial numbers of the gun and of the tube will usually be different. The serial number on the receiver is the actual serial number of the gun. Any reports sent in should, however, give both serial numbers.

b. Current Modifications. Several modifications of the gun described in TM 9-227, 19 November 1942, have been adopted by the Army and Navy. These modifications (figs. 3, 11, and 12), which do not affect troop use, are as follows:

(1) The inertia blocks with plungers and springs have been replaced by solid inertia blocks which do not have oil grooves.

(2) The coil extractor spring has been replaced by a cantilever (pin) spring.

(3) The transverse slot in the firing pin has been elongated by about $\frac{1}{16}$ inch to permit movement of the firing pin on the breechblock slide key.

(4) The breechblock lock has been filleted on the sides.

(5) The breechblock slide springs are heavier than those of early manufacture.

3. MODEL OF GUN USED BY THE NAVY.

a. The Navy uses the AN-M2 model, type E only (fig. 24).

4. MODELS OF GUN USED BY THE ARMY.

a. The army uses both the M1 and AN-M2 models, types A, B, C, and D (figs. 23 and 24).

b. Differences Between Models. The differences between the AN-M2 and M1 Guns are in manufacture only; these do not affect troop use or care, but are useful as means of identifying the different models. The guns are identical with respect to the construction of the tube and the working parts, the only differences being in the dimensions of some of the receiver parts. The AN-M2 receiver is 0.2 inch longer. Each receiver slide of the AN-M2 Gun has a projection which fits into a slot in the side of the receiver, and the receiver slide bolts are locked by cotter pins (fig. 4). In the M1 Guns, the receiver slides have no flanges and are riveted instead of bolted to the receiver. The shoulders on the bottom faces of the receiver sides serve as further

20-MM AUTOMATIC GUN M1 AND
20-MM AIRCRAFT AUTOMATIC GUN AN-M2

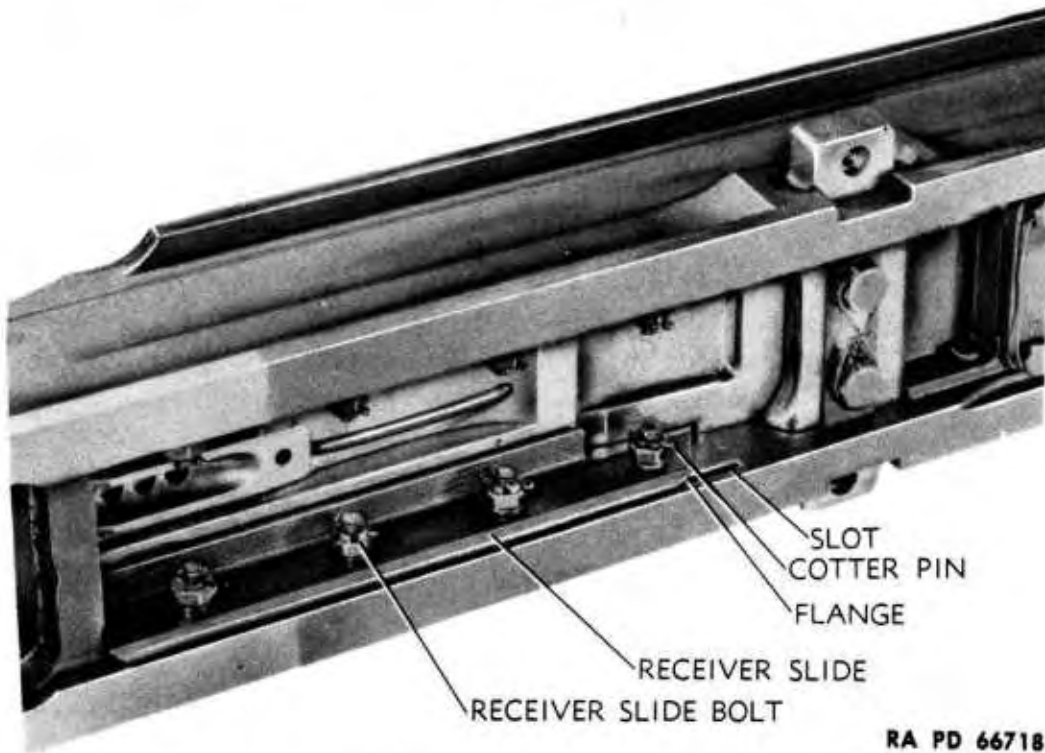

Figure 4 – Identification Marks on the AM-M2 Gun

means of identifying the M1 Gun (fig. 5). In some M1 Guns each receiver slide has a flange which overlaps the side of the receiver and the receiver slide bolts are locked by locking wire.

NOTE: The designations M2 and AN-M2 refer to the same gun. The name AN-M2 has been standardized by the Army and Navy for the M2 Gun.

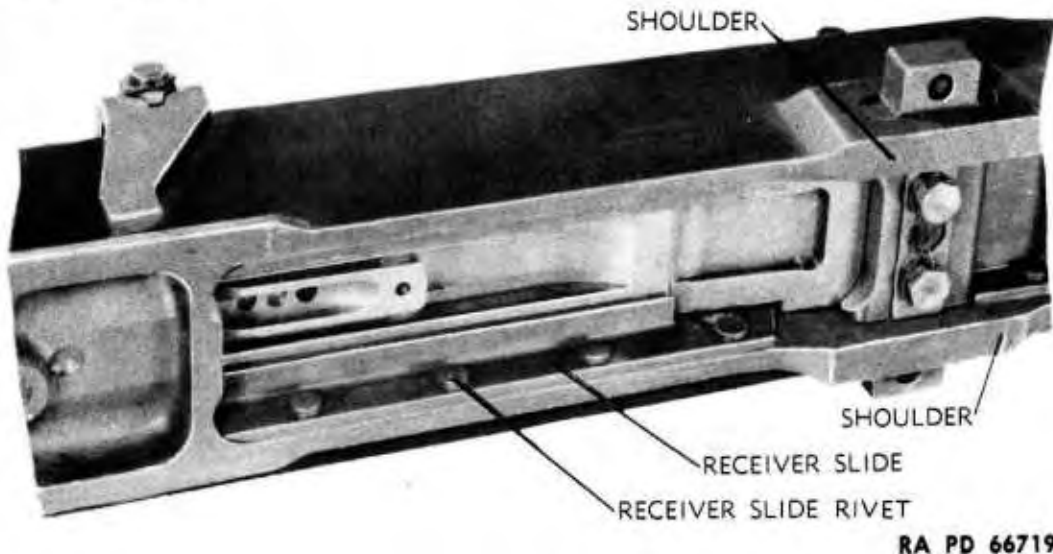

Figure 5 – Identification Marks on the M1 Gun

INTRODUCTION

5. DATA.

Weight of basic gun M1 or AN-M2 (approx.).....	102 lb
Over-all length of basic gun (approx.).....	93.7 in.
Weight of tube.....	47.5 lb
Length of tube.....	67.5 in.
Weight of 20-mm adapter AN-M1.....	11.3 lb
Weight of electric trigger AN-M1.....	5 lb
Weight of hydraulic charger M1.....	2.6 lb
Weight of 20-mm feed mechanism AN-M1.....	18 lb
Weight of 20-mm adapter M6.....	14 lb
Weight of 20-mm adapter M7 (thread protector).....	7.5 lb
Weight of 20-mm adapter M7 (muzzle brake).....	10.7 lb
Weight of muzzle brake M1.....	4.6 lb
Weight of sear mechanism M1.....	1.3 lb
Weight of manual charger M2.....	1.5 lb
Weight of 60-round 20-mm magazine M1 (empty)....	22 lb
Muzzle velocity (HE-I or Ball ammunition).....	2,850 ft per sec
Muzzle velocity (A.P. ammunition).....	2,950 ft per sec
Rate of fire.....	600 to 700 rounds per min
Rifling:	
Number of grooves.....	9
Depth of grooves.....	0.015 in.
Width of grooves.....	0.205 in.
Width of lands.....	0.068 in.
Twist, uniform, right-hand, slope.....	7 deg
Length.....	63.08 in.
Bore of tube:	
Across rifling lands.....	0.787 in.
Across rifling grooves.....	0.817 in.
Chamber pressure (max.).....	42,000 lb per sq in.
Travel of projectile in tube.....	63.68 in.

6. PRECAUTIONS.

a. All rounds should be lubricated just before they are inserted in the magazine or belt. Dip a cloth in OIL, lubricating, preservative, special. Then wring it out and wipe the cartridge case with it, applying a light film of oil. Extreme care must be taken to avoid oiling the primer (base of the case) or the joint where the case is crimped to the projectile.

**20-MM AUTOMATIC GUN M1 AND
20-MM AIRCRAFT AUTOMATIC GUN AN-M2**

b. Place the breechblock in the most forward (locked) position whenever the gun is to be disassembled. This is to reduce the tension on the driving spring and prevent possible injury when removing the driving spring guide.

c. Do not keep gun charged for any extended period of time.

d. Make certain that the gun is charged before take-off on all planes not equipped with remote-control chargers.

e. When checking the gun after assembly never allow the breechblock to go forward home under the pressure of the driving spring unless there is an empty shell or dummy round in the chamber. The empty shell acts as a cushion to prevent damage to the breechblock or tube.

f. Inspect all guns to see that the rear buffer threaded sleeve is staked to the housing at three places. This is done to prevent the sleeve from unscrewing during firing. Extreme caution must be exercised, however, not to overstrike, as difficulty may be experienced in removing the stake when it is necessary to replace the rear buffer spring.

Section II

DESCRIPTION, FUNCTIONING, AND INSTALLATION

	Paragraph
Basic gun	7
Functioning of the gun as a whole.....	8
Gun type designation	9
Adapters	10
Sear actuating mechanisms.....	11
Chargers	12
Feed mechanisms	13

7. BASIC GUN.

a. **Tube** (figs. 6 and 7). The principal components of the basic gun are the receiver which houses most working parts, and the tube. The tube is threaded at both ends and has a radial gas port about 20 inches from the breech end. The breech end is screwed into the receiver and is secured with a locking pin to prevent the tube from vibrating loose during firing. The breech face of the tube is recessed to clear the lip of the extractor. The tube serves to accommodate the front mounting arrangements.

b. **Gas Cylinder and Sleeve Group** (figs. 8 and 79). The function of this group is to assist in unlocking the breechblock. It consists of a piston integral with a sleeve extension terminating in the form of a yoke which engages two push rods projecting through the front of the receiver. The gas cylinder piston is contained in and guided by the gas cylinder, the front end of which fits into the gas cylinder bracket and is secured by the threaded gas cylinder vent plug. The bracket is shrunk-fit over the gas port on the tube and is closed at the top by the gas cylinder bracket plug. The plugs are secured by a gas cylinder lock plate, washer, and locking wire. The vent plug has an opening through which a portion of the propellant gases is bled from the tube to force the piston and sleeve back. The sleeve is free to slide on the gas cylinder guide and force the two push rods against the breechblock slides. This action unlocks the breechblock. A piston spring, housed in the sleeve, returns the piston and sleeve to the forward position.

c. **Receiver Assembly** (fig. 9).

(1) The receiver houses most of the working parts. It consists of the receiver body and the receiver plate which is riveted to the rear under side.

(2) At the front end, the body is threaded internally to receive the tube; a vertical hole is drilled from the under side to accommodate

20-MM AUTOMATIC GUN M1 AND
20-MM AIRCRAFT AUTOMATIC GUN AN-M2



Figure 6 — Tube of Gun



Figure 7 — Tube — Front Portion

DESCRIPTION, FUNCTIONING, AND INSTALLATION



RA PD 70367

Figure 8 — Gas Cylinder and Sleeve Group

**20-MM AUTOMATIC GUN M1 AND
20-MM AIRCRAFT AUTOMATIC GUN AN-M2**

the tube locking pin. On top of the body is a lug which is threaded internally to receive the gas cylinder sleeve guide.

(3) On each side below the lug, longitudinal holes are drilled through the front of the body to house the push rods which push the breechblock slides to the rear. This action unlocks the breechblock lock.

(4) Integral with the right side of the receiver is a cylindrical charger housing which can be fitted with a manual or hydraulic charger for retracting the breechblock. A slot in the rear half of the charger housing permits the lug on the right breechblock slide to protrude into the housing so it can be engaged by the charger.

(5) The front under side of the body is open to permit ejection of empty cartridge cases. Above the ejector opening are two receiver slides which are bolted or riveted to the sides of the receiver and serve to support the breechblock in its forward movement. The slides have cammed surfaces at the rear which engage corresponding cams on the breechblock lock so as to cam it into the locked position, with the assistance of the camming action of the breechblock slides, as described in subparagraph e (3) below. To the rear of the ejector opening, a transverse slot is cut in each side of the receiver body to accommodate the breechblock locking key. The breechblock locking key engages the breechblock lock when the lock is cammed down into the locked position.

(6) At the rear, the under side of the receiver is partially closed by the receiver plate. The plate is designed to house the sear block group and to accommodate a firing mechanism.

(7) The rear of the body has vertical dovetail grooves for attaching the rear buffer assembly. Two guideways on top of the receiver body accommodate the magazine slide group. The magazine slide group mounts the ejector and provides a means for securing a feed mechanism to the gun.

d. Magazine Slide Group (figs. 10 and 78).

(1) The magazine slide has a guide on each side which provides for sliding engagement with corresponding guideways on the receiver body. Two longitudinal grooves are provided at the rear of the slide to accommodate the ejector and magazine latch. The magazine latch fits in the two upper grooves of the slide. The latch houses two springs which abut the magazine slide back plate and keep the latch under tension. The latch is operated by means of the magazine slide lever which is supported on two ears on the magazine slide by means of the magazine slide lever pin and bushing.

DESCRIPTION, FUNCTIONING, AND INSTALLATION

R.A. PD 68798



Figure 9 — Receiver Assembly

20-MM AUTOMATIC GUN M1 AND 20-MM AIRCRAFT AUTOMATIC GUN AN-M2

(2) The feed mechanism is secured to the magazine slide at the front by the two hook-shaped projections on the slide, and at the rear by the magazine slide latch.

(3) The ejector fits into the lower two grooves in the magazine slide beneath the latch. It consists of two prongs projecting from a steel plate. The ejector plate houses two springs which contact the magazine slide back plate, and is fitted with a threaded stud. The stud passes through the back plate and is attached by a nut.

(4) The upper inner surfaces of the prongs are shaped to center the incoming round into the path of the breechblock as it moves forward. The top shoulders of the bolt move between the two prongs of the ejector. The prongs deflect the empty cartridge case downward as the breechblock moves to the rear.

e. Breechblock Assembly (figs. 11, 12, and 77).

(1) The breechblock assembly consists of the bolt assembly, two breechblock slides with springs and guides for the springs, a breechblock slide key, inertia blocks, firing pin, breechblock lock, and extractor, extractor spring, and breechblock slide key. The whole group is housed in the receiver. Its function is to carry the round from the mouth of the feed mechanism into the chamber, fire the round, extract and eject the empty case, and support it until it is deflected out of the receiver by the ejector.

(2) The bolt is bored from the rear to receive the firing pin, driving spring guide plunger, and driving spring. The upper shoulders of the bolt are cut away to clear the horns of the ejector, while the front face is recessed to accommodate the base of the cartridge case. The bottom of the bolt is recessed at the rear to receive the breechblock lock and at the front for securing the extractor. The extractor is attached by means of the extractor pin. A spring between the extractor and the bolt forces the claw at the forward edge of the extractor toward the face of the bolt. The extractor supports the empty shell from the chamber during the rearward motion of the bolt and supports it until it strikes the two prongs of the ejector. The extractor is then pivoted downward to allow ejection of the shell.

(3) Flanges along the lower edges of the bolt provide surfaces for guiding the breechblock slides. The slides are keyed together by means of a slide key passing through a slot near the forward end of the bolt. The breechblock slide key passes through a transverse slot in the firing pin with a clearance of approximately $\frac{1}{16}$ inch so that the firing pin can slide on the key. The lug on the rear end of the right breechblock slide extends through a slot into the charger housing for

DESCRIPTION, FUNCTIONING, AND INSTALLATION

RA PD 66723

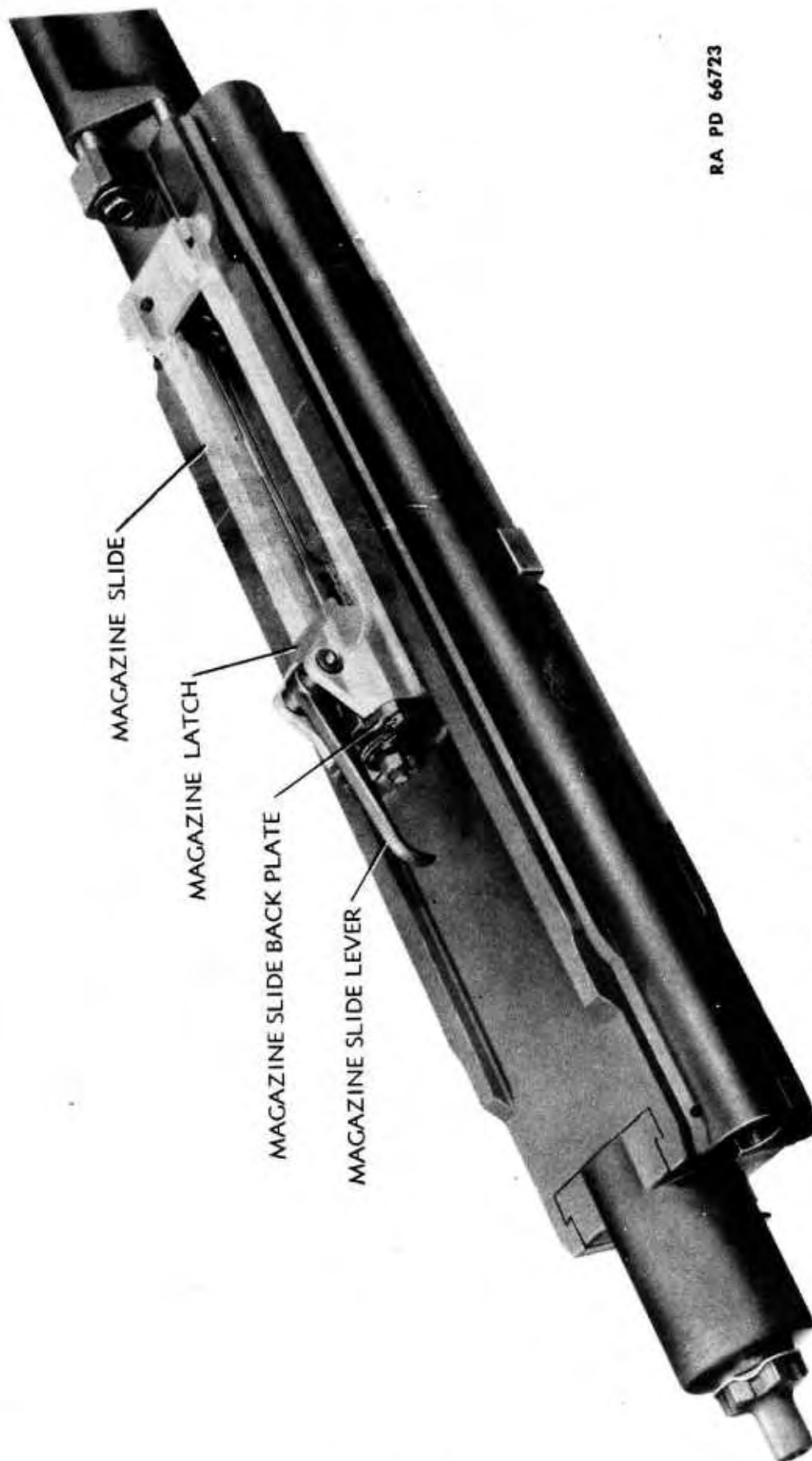
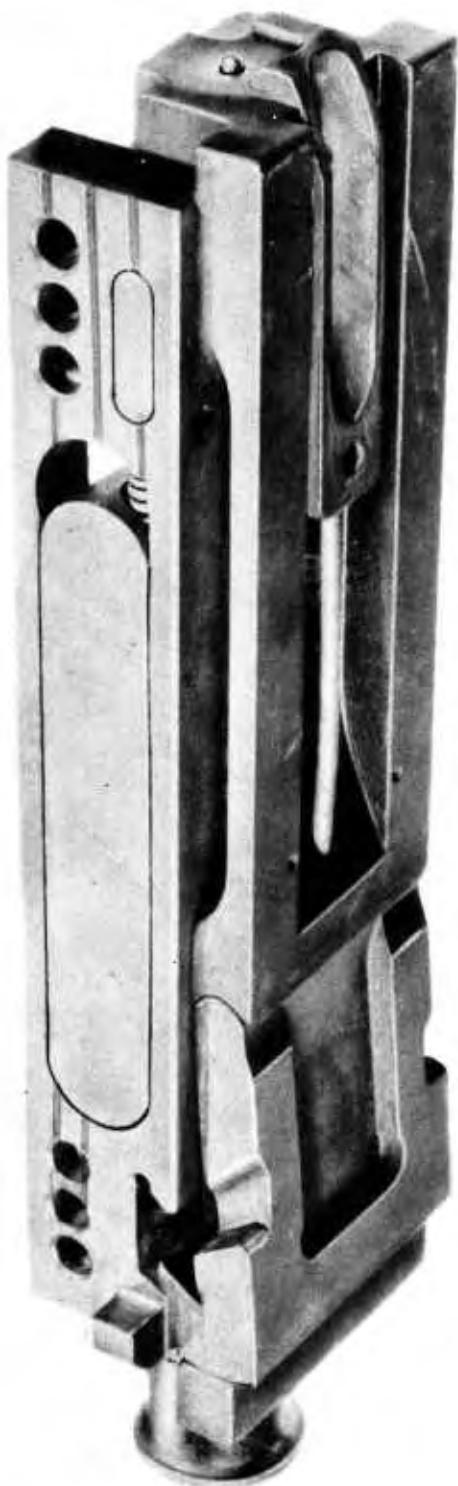

Figure 10 — Magazine Slide Group

20-MM AUTOMATIC GUN M1 AND
20-MM AIRCRAFT AUTOMATIC GUN AN-M2



RA PD 66721

Figure 11 — Breechblock Assembly — Present Manufacture

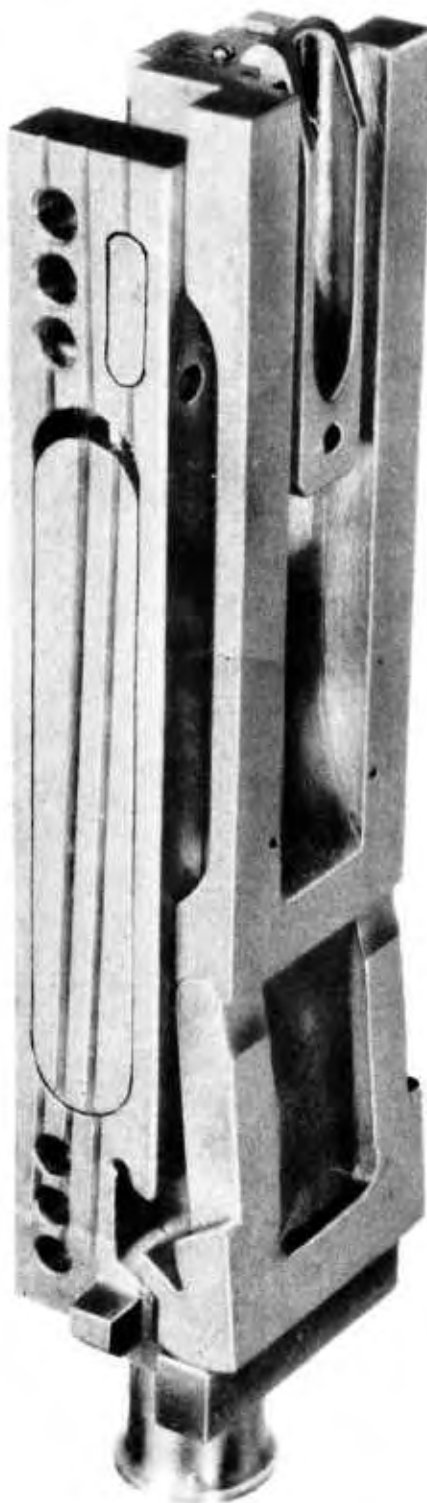

RA PD 68823

Figure 12 — Breechblock Assembly — Early Manufacture

DESCRIPTION, FUNCTIONING, AND INSTALLATION

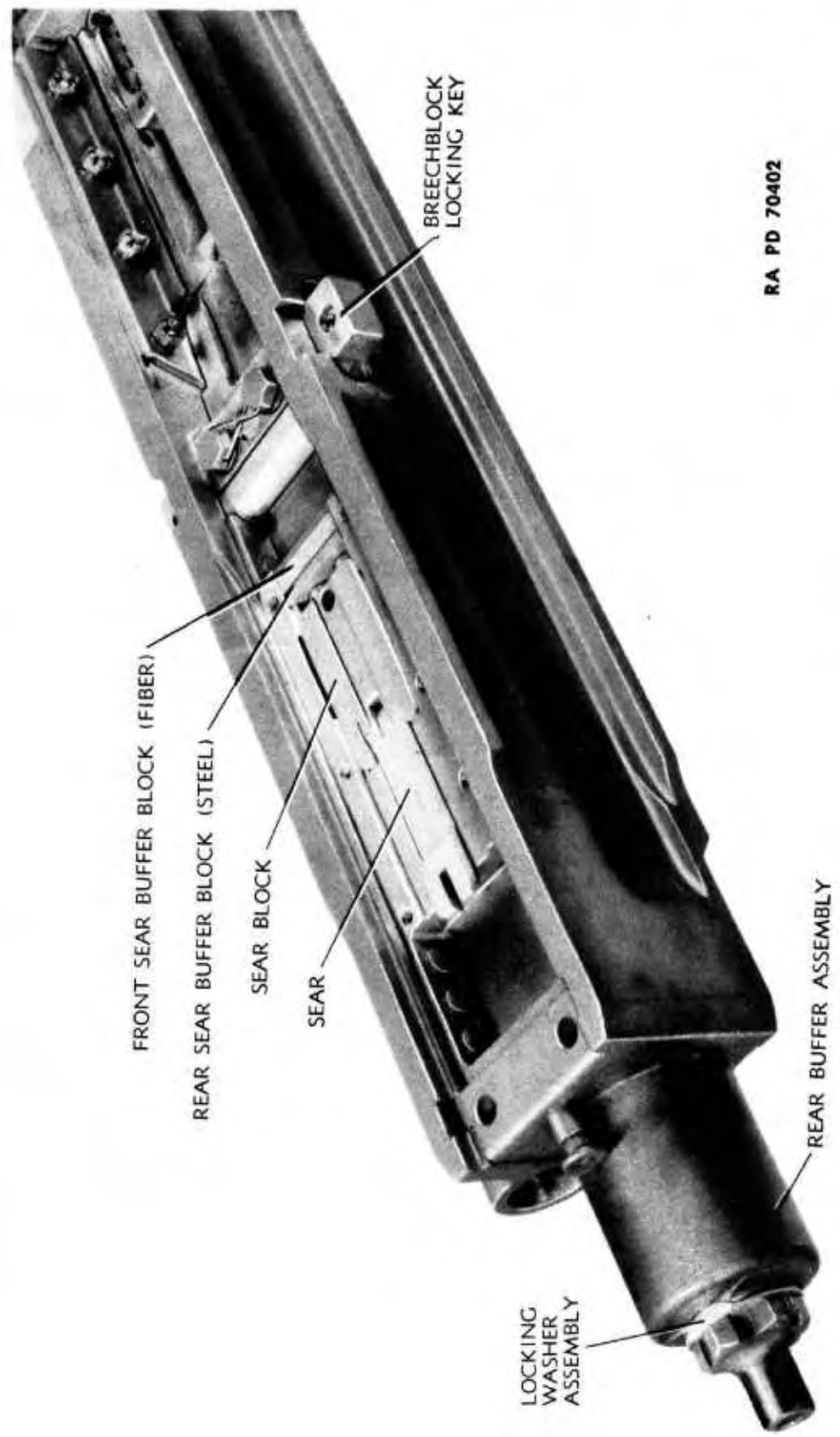

RA PD 70402

Figure 13 — Sear Block Group and Breechblock Locking Key

20-MM AUTOMATIC GUN M1 AND 20-MM AIRCRAFT AUTOMATIC GUN AN-M2

engagement with the charger. The rear of each breechblock slide spring guide passes through the hole in the breechblock pin and the front ball of the guide bears in a recess in the slide. The spring, which is mounted around the guide helps to drive the slides forward into the firing position and to prevent rebound of the slides. The bottom edges near the rear of the slides are cut to form cam surfaces. The foremost cam surfaces contact corresponding cam surfaces on the breechblock lock to unlock the breechblock lock. The rearmost cam surfaces act against the level at the rear of the breechblock lock during the forward motion of the slides, and assist the locking action of the receiver slides in lowering the lock into the locked position.

(4) A large slot in each breechblock slide accommodates an inertia block. The inertia blocks are cut away on the under side to accommodate the breechblock slide springs and guides. The function of the inertia blocks is to prevent rebound of the breechblock slides. The shallow grooves in the breechblock slides serve to distribute the lubricant and to collect any foreign matter.

(5) The breechblock lock is a flat plate with cams projecting from each side of its top surface. The rear surface of the lock is designed to engage the breechblock locking key. The rounded front edge of the lock hinges in the recess on the under side of the bolt. The bottom of the lock is recessed to engage the sear.

NOTE: In guns of earlier manufacture the breechblock assembly differs from the one described above as follows: The inertia blocks are provided with plungers and springs; the firing pin fits snugly over the breechblock slide key; the extractor spring is coiled; the inertia blocks have shallow grooves to distribute lubricant and collect foreign matter.

f. Breechblock Locking Key (fig. 13). The breechblock locking key passes through the transverse slots in the sides of the receiver. It is prevented from moving laterally by the plate positioned between the sides of the receiver body and secured to the key by screws and lock washers. The screws are locked by locking wire. The top front face of the key is beveled to permit engagement by the breechblock lock when it is cammed down into the locked position. Two tapped holes are located in the ends of the key which protrude past the sides of the receiver. These two outside holes provide a means for mounting the rear of the gun in some airplane installations. Below the bevel are two projections which support the breechblock lock when it is lowered to the locked position.

g. Sear Block Group (figs. 13 and 82). The sear block group consists of the sear and sear block, together with sear buffer springs, plungers, and blocks. The sear is hinged to the rear of the sear block

DESCRIPTION, FUNCTIONING, AND INSTALLATION

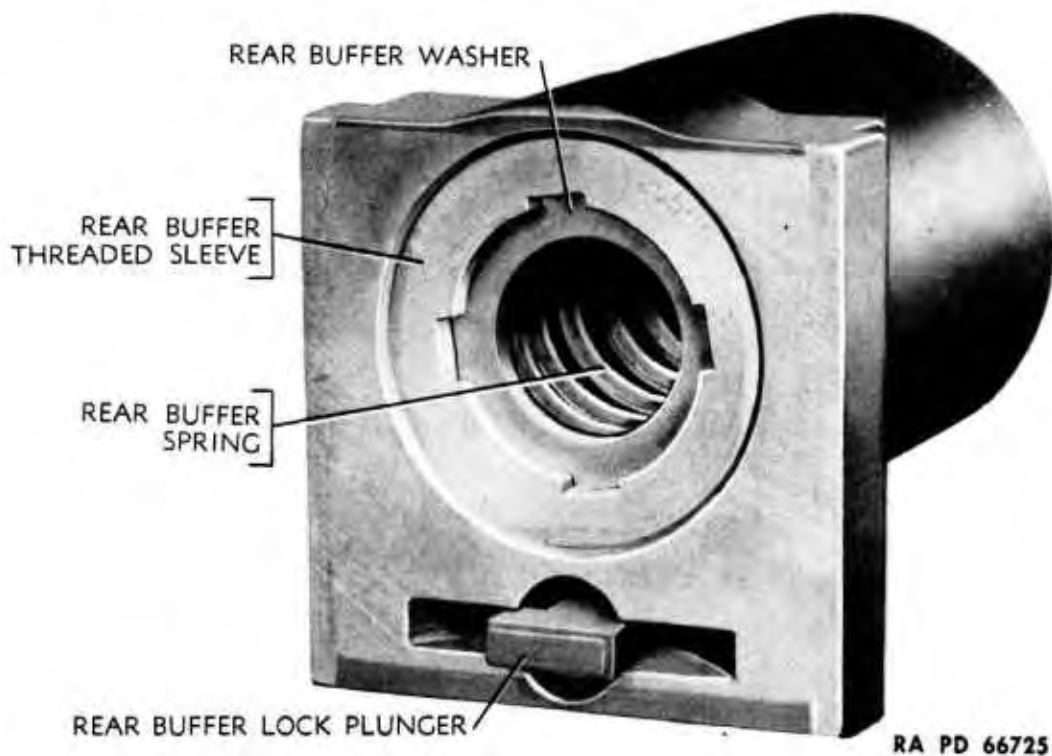

Figure 14 – Rear Buffer Assembly

by a pin. The rear of the sear is forked for engagement with the shaft of a firing mechanism. The sear is operated by the shaft of a firing mechanism and its function is to retain the breechblock in the retracted position by engaging the recess in the bottom of the breechblock lock. The sear block is drilled through the front to house the sear buffer springs and plungers. The sear buffer blocks, one of steel and one of fiber, provide a front abutment for the sear buffer springs and plungers. The steel block should be adjacent to the plungers; the flat surface of the fiber block should be adjacent to the steel block. The function of the sear buffer springs is to absorb the shock when the sear and breechblock engage. Any pressure on the sear is taken on the radial bearing surfaces of the sear and sear block and not on the pin itself. The vertical hole near the front of the sear block is for inserting the sear buffer spring retaining tool. The tool engages the circumferential grooves on the plungers and holds the springs under compression when the group is removed or replaced (fig. 80).

h. Rear Buffer Assembly (figs. 13, 14, and 72).

(1) The rear buffer assembly is joined to the receiver body by means of a dovetail connection and a lock plunger which engages a slot in the receiver plate and prevents vertical sliding of the rear buffer. The function of the rear buffer is to cushion the shock of the recoiling breechblock assembly, stop the recoil, and start the breech-

20-MM AUTOMATIC GUN M1 AND
20-MM AIRCRAFT AUTOMATIC GUN AN-M2

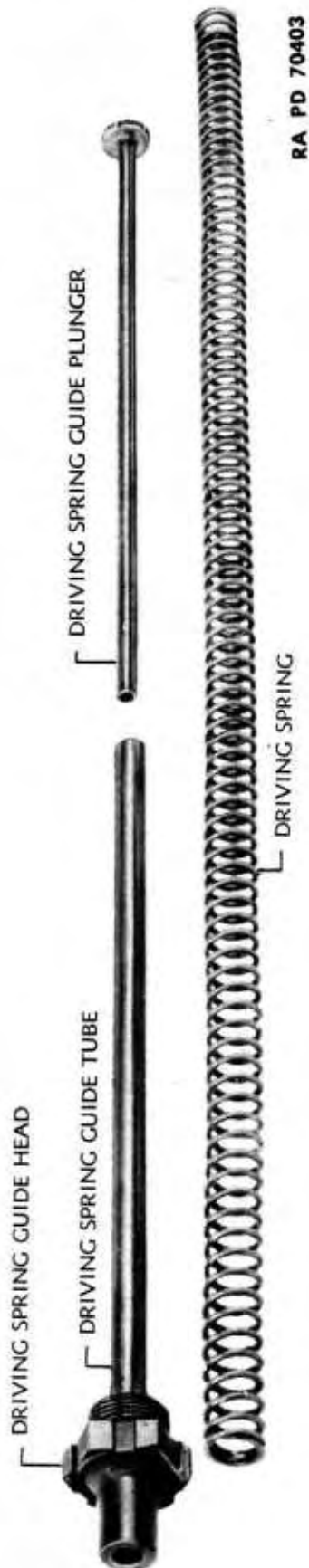
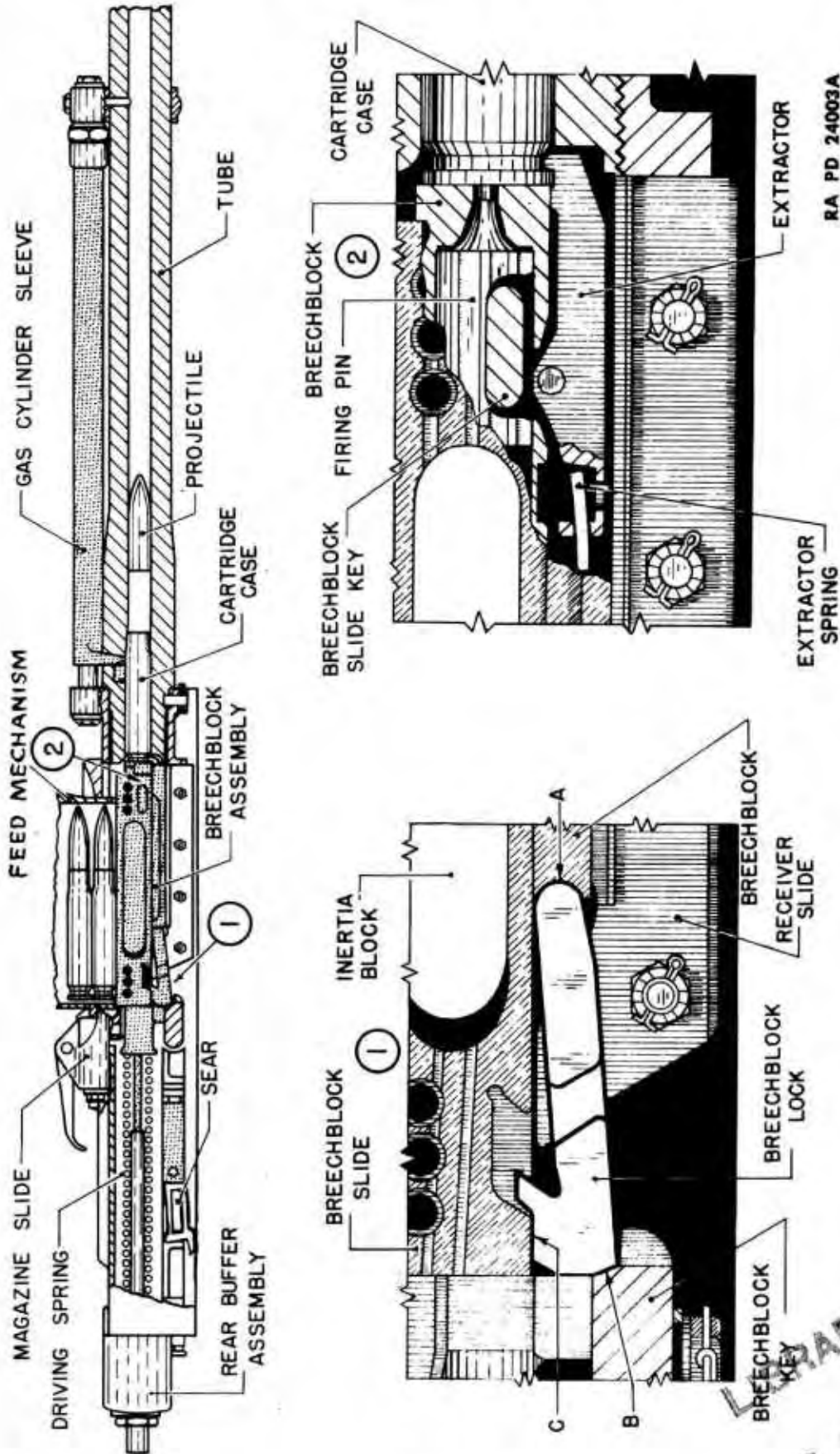

Figure 15 — Driving Spring Guide Group

DESCRIPTION, FUNCTIONING, AND INSTALLATION



RA PD 24003A

Figure 16 — Gun Mechanism Shortly After Firing

56839

APR 10 1946
U.S. PATENT OFFICE

20-MM AUTOMATIC GUN M1 AND
20-MM AIRCRAFT AUTOMATIC GUN AN-M2

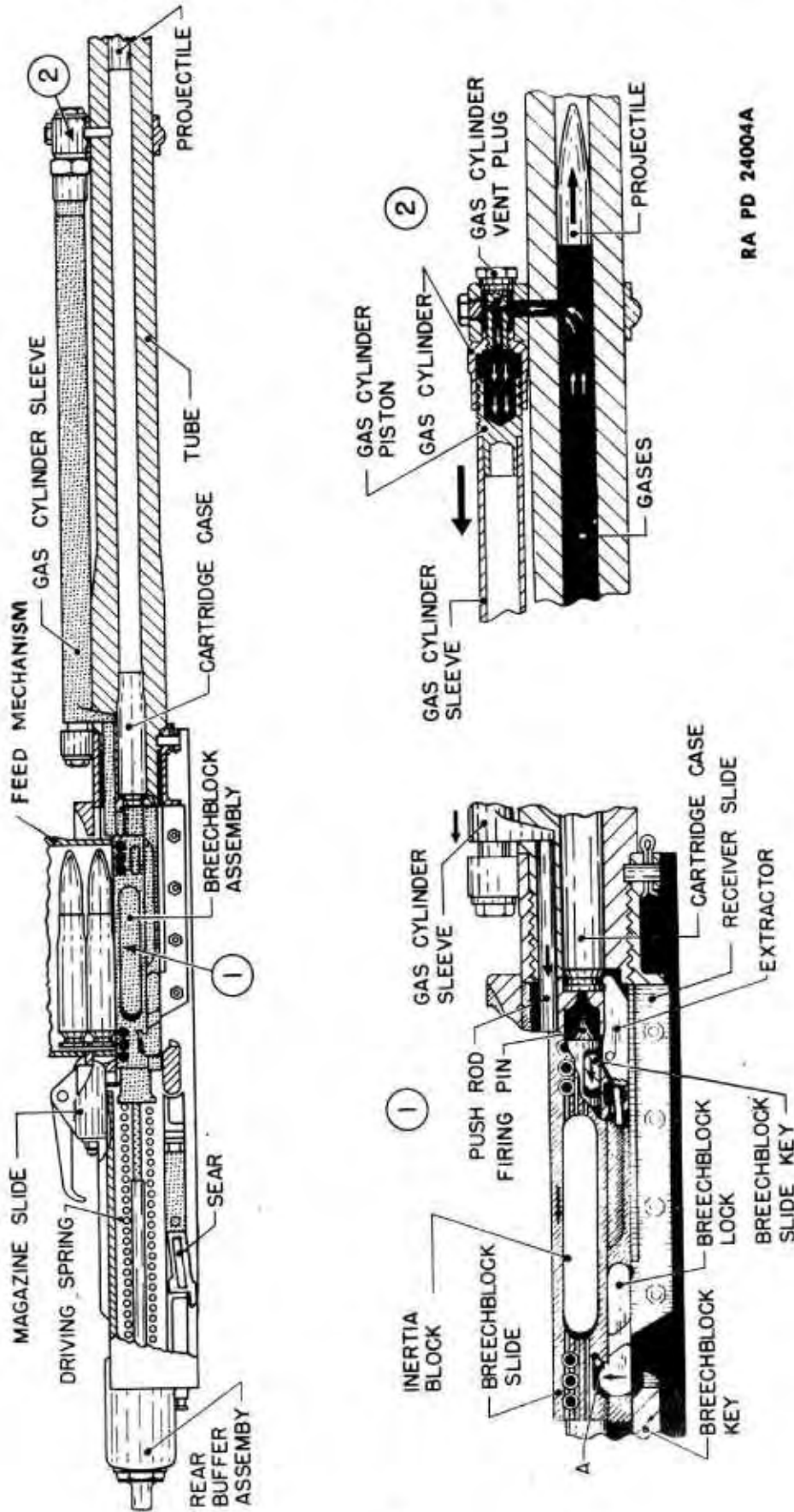

RA PD 24004A

Figure 17 — Gun Mechanism During Breechblock Unlocking

DESCRIPTION, FUNCTIONING, AND INSTALLATION

block assembly on its forward movement. This action, plus the action of the driving spring, accelerates the breechblock assembly rapidly on the start of its forward motion, and thus maintains firing speed. The rear buffer houses a spring which is placed under initial compression by screwing the rear buffer threaded sleeve into the housing until it bottoms. Between the spring and flange of the sleeve is a washer which transmits the shock of recoil to the spring when the breechblock is driven to the rear on the recoil stroke. The rear face of the buffer housing is threaded to receive the driving spring guide head.

(2) The rear buffer is provided with a retainer assembly which prevents the driving spring guide head from unscrewing. The assembly is a washer with a flange and a pin projecting from the face. The pin engages a hole in rear buffer housing and the flange engages a recess on the housing. In assembling, the rim of the washer is bent over a flat of the driving spring guide head to lock it.

i. **Driving Spring Guide Group** (fig. 15). The driving spring guide group consists of the driving spring, guide, and plunger. The plunger fits into the interior of the bolt and the head rests against the back of the firing pin while the rear end slides in the driving spring guide tube. The driving spring is positioned between the head of the plunger and the head of the driving spring guide. The function of the driving spring is to drive the breechblock group forward to fire an initial round and assist in firing all rounds. It also retards the rearward motion of the bolt.

8. FUNCTIONING OF THE GUN AS A WHOLE.

a. The following is an account of a complete firing cycle from the explosion of one propelling charge to the next.

(1) At the moment of firing, the projectile starts down the tube, propelled by the expanding gases. The firing pin is in its forward position, having struck the primer of the cartridge. The breechblock is held in its forward position by the action of the breechblock lock. The lock engages the breechblock at point "A," figure 16, and bears against surface "B," figure 16, of the breechblock key. The breechblock slide engages the lock at point "C," figure 16, preventing the lock from being forced upward prematurely.

(2) As the projectile moves forward, it passes the gas port (fig. 17). A portion of the expanding gases enters the gas port, passes through the gas cylinder vent plug, enters the gas cylinder, and exerts pressure on the gas cylinder piston. This piston moves rearward, carrying with it the gas cylinder sleeve. The yoke on the rear end of the gas cylinder sleeve engages the push rods and carries them rearward. The push rods, in turn, contact the breechblock slides. The slides are connected

20-MM AUTOMATIC GUN M1 AND
20-MM AIRCRAFT AUTOMATIC GUN AN-M2

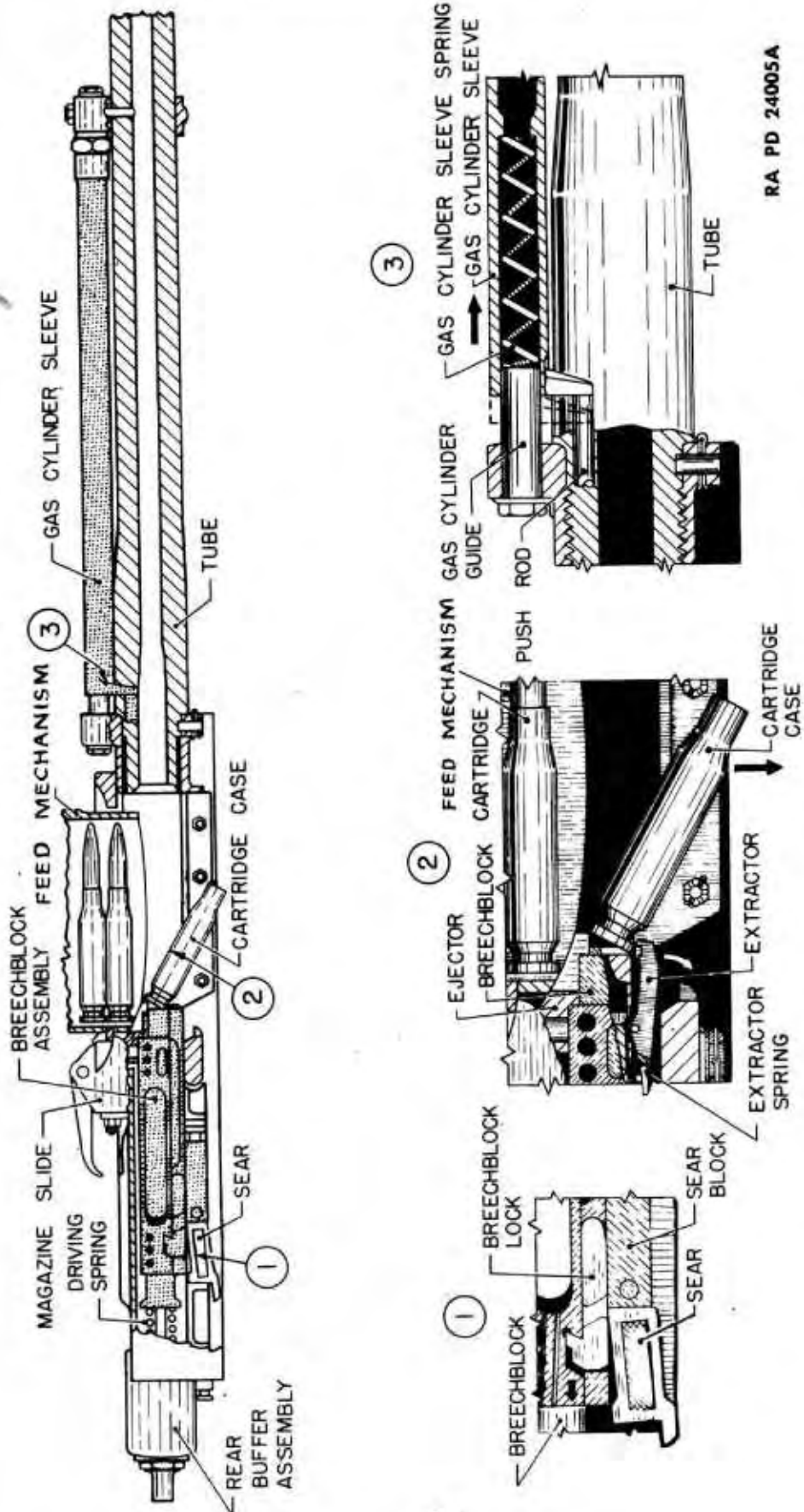

Figure 18 — Gun Mechanism — Cartridge Being Ejected

DESCRIPTION, FUNCTIONING, AND INSTALLATION

by the breechblock slide key, which also engages a slot in the bottom of the firing pin. As the breechblock slides are forced rearward by the push rods, the key carries the firing pin rearward. When the lock has been brought to a horizontal position the breechblock is forced to the rear by direct blowback.

(3) When the breechblock assembly is moved to the rear, the empty cartridge case which has been forcing the bolt back by blowback action is contacted on the upper edge by the two prongs of the ejector (fig. 18), forcing the cartridge case to pivot about and force downward the forward end of the extractor. The cartridge case leaves the lip of the extractor and moves through an opening in the bottom of the receiver, completing the ejection of the empty cartridge case (fig. 18). When the cartridge case frees itself from the extractor, the extractor is returned to its normal position by the action of the extractor spring. By this time the gas cylinder sleeve has been returned to its forward position. The gas cylinder sleeve spring, which was compressed during the rearward movement of the sleeve, expands when the gas pressure drops, forcing the sleeve and piston forward.

(4) When the breechblock is sufficiently far to the rear to clear the feed mechanism, a new round is forced downward into the mouth of the feed mechanism by a spring in the mechanism that maintains pressure on the new rounds. In recoiling, the breechblock compresses the driving spring. As the breechblock nears the end of its rearward movement, it strikes the rear buffer and compresses the buffer spring, which absorbs the remaining force of recoil and brings the breechblock to a stop (fig. 19). As the breechblock comes to a stop, the inertia blocks continue to move rearward in their slots in the breechblock slides until they reach the end of the slots. By this time the breechblock has started forward again and the inertia blocks remain in a rearward position with respect to the breechblock slides during the forward motion of the breechblock. The function of the sear will be described later, but it should be noted at this point that it is held in a downward position during automatic fire, allowing the breechblock to move through its cycle without being caught and held at the rear.

(5) The rear buffer spring and the driving spring expand, forcing the breechblock forward (fig. 20). During this motion the breechblock engages the new cartridge which has been positioned in the mouth of the feed mechanism. As the cartridge is forced forward, it drops into the recess in the bolt where it is gripped by the lip on the extractor as it enters the chamber.

(6) As the breechblock reaches the end of its forward motion (fig. 21), it seats against the end of the tube, closing the chamber. The momentum of the slides and the action of the slide springs cause the slides

20-MM AUTOMATIC GUN M1 AND
20-MM AIRCRAFT AUTOMATIC GUN AN-M2

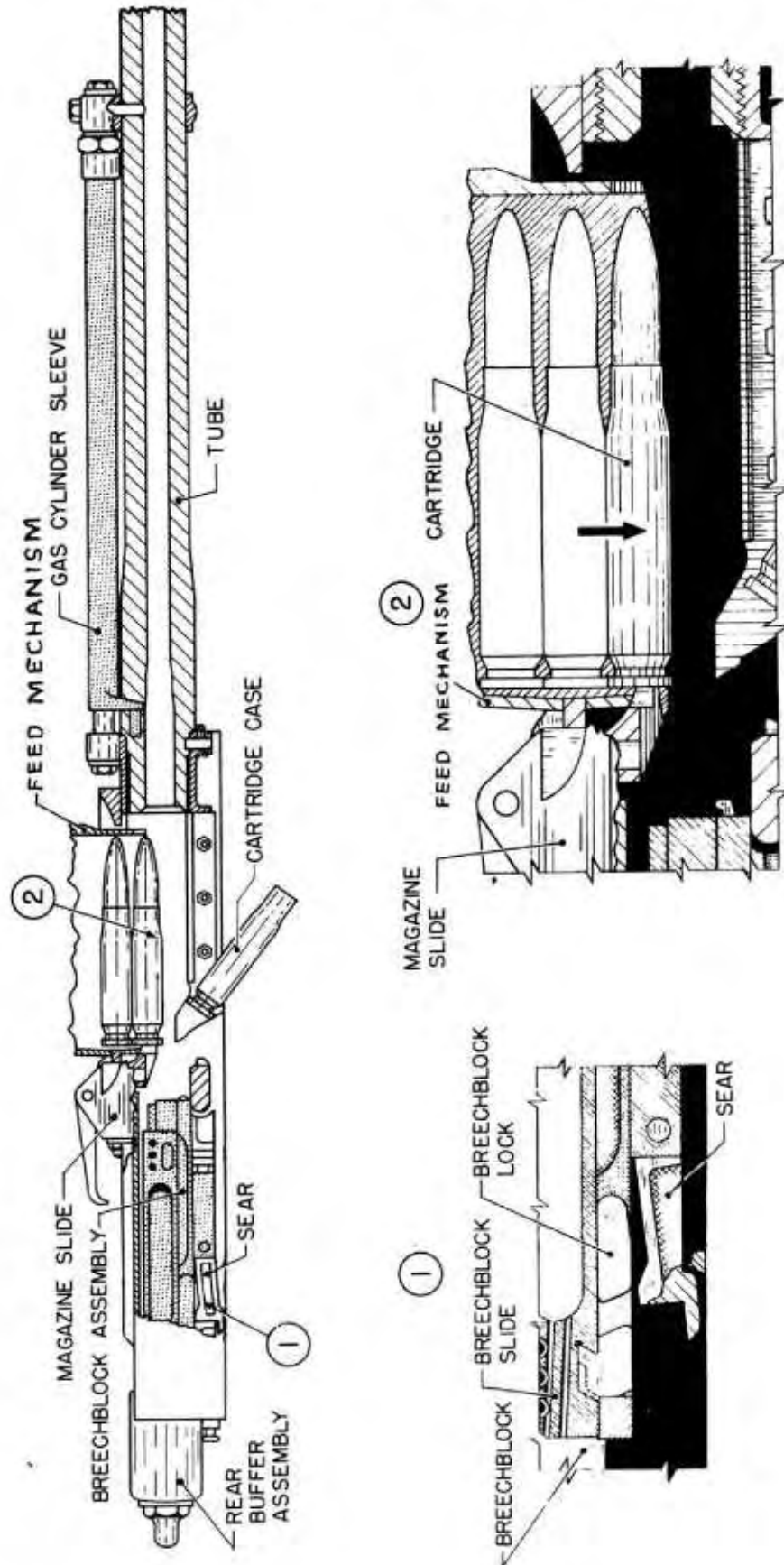

RA PD 24006A

Figure 19 — Gun Mechanism — Breechblock in Rearmost Position

DESCRIPTION, FUNCTIONING, AND INSTALLATION

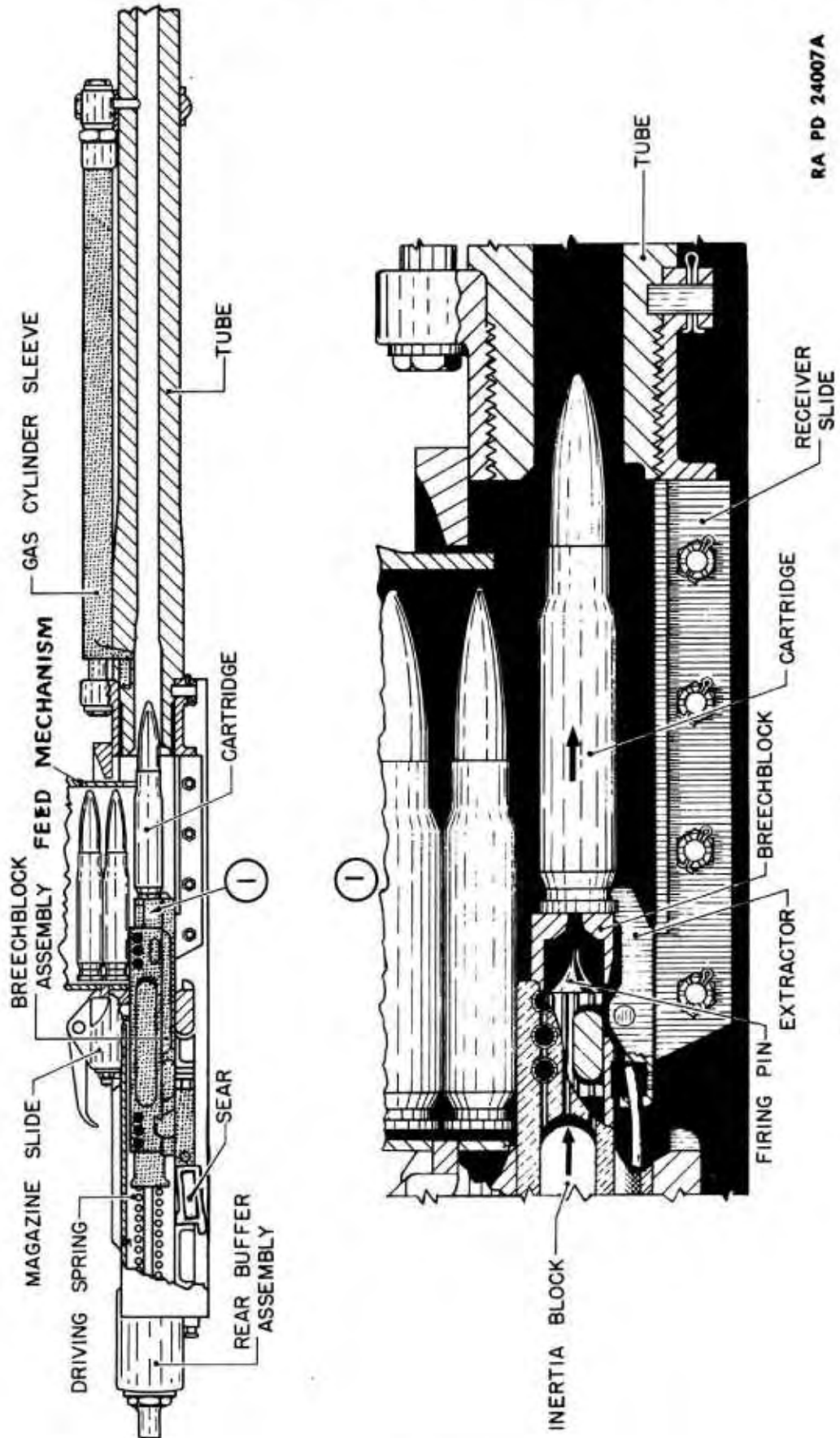

RA PD 24007A

Figure 20 - Gun Mechanism During Ramming

20-MM AUTOMATIC GUN M1 AND
20-MM AIRCRAFT AUTOMATIC GUN AN-M2

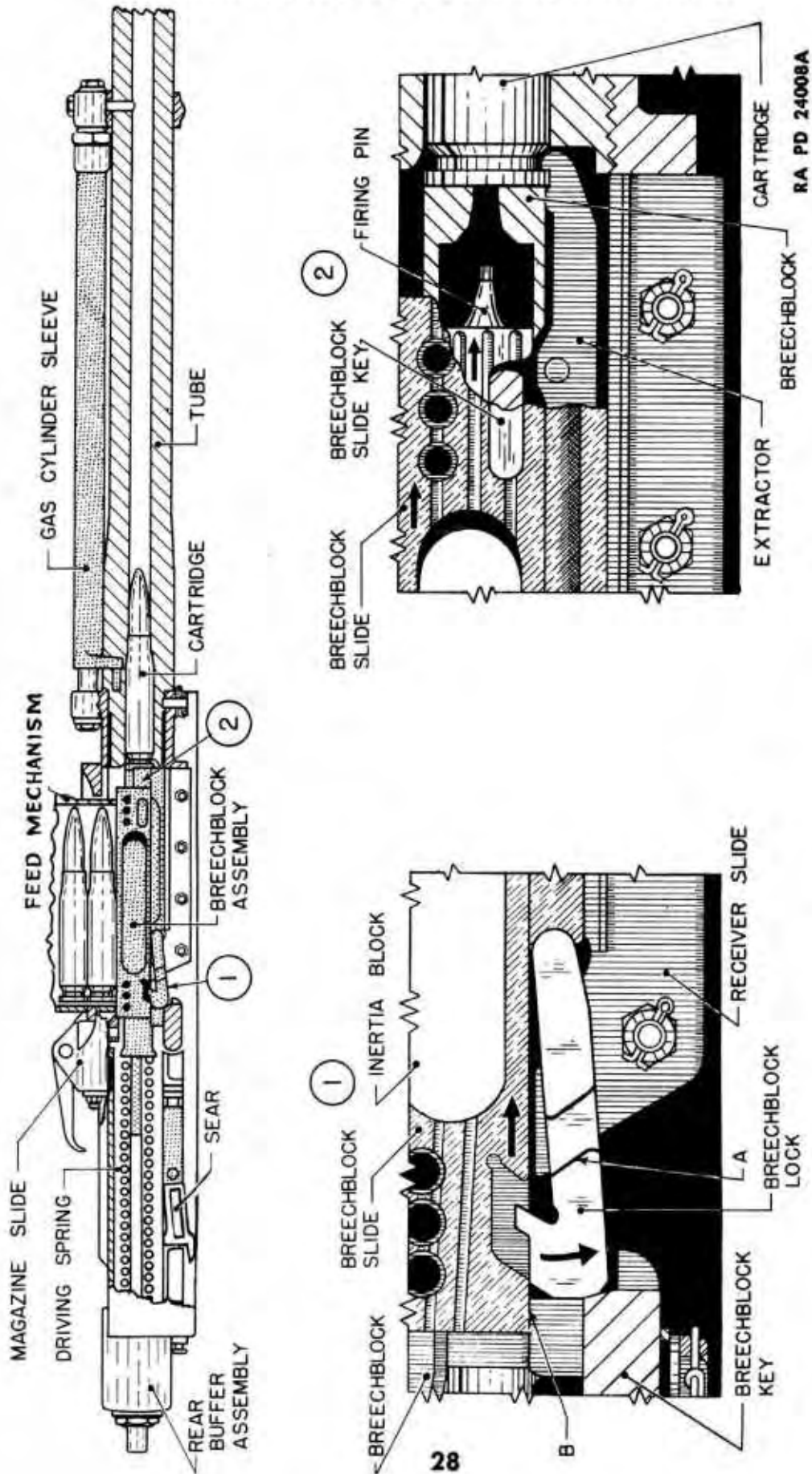

Figure 21 — Gun Mechanism Ready to Fire

DESCRIPTION, FUNCTIONING, AND INSTALLATION

to continue to move forward, releasing the breechblock lock. At the same time, projecting cams "A," figure 21, of the lock are engaged by cam surfaces on the receiver slides which, together with the action of the breechblock slide cams on the level of the lock, cam the lock downward. The lock seats against the breechblock key and is locked in its downward position by the lower surface "B," figure 21, of the slides which move over the end of the lock. When the slides reach the end of their forward motion, the inertia blocks continue to move forward for a short distance, counteracting any tendency that the slides might have to rebound. As the breechblock slides continue forward, they carry the firing pin with them on the breechblock slide key. The firing pin is free to move on the breechblock slide key and will continue forward under the force of its inertia. Thus the firing pin will strike the primer even though the breechblock slides may rebound slightly. As the firing pin strikes the primer of the cartridge, it fires it and starts the cycle all over again.

(7) To stop firing of the gun, the firing mechanism is released (fig. 22) and the sear is forced upward. As the breechblock moves rearward, it forces the sear down. As the breechblock moves forward, the sear rises again and enters a recess on the under side of the breechblock lock, engaging the lock at point "A," figure 22, and stopping the forward motion of the breechblock assembly. The shock is taken up by the sear buffer springs and plungers in the sear block.

9. GUN TYPE DESIGNATION.

a. The following gun type designation is based on the kind of adapter, sear actuating mechanism, and charger used with the basic M1 or AN-M2 Gun.

(1) Type A is used by the U.S. Army Air Forces. It consists of the basic M1 or AN-M2 Gun with AN-M1 adapter, AN-M1 electric trigger, and M2 manual charger (fig. 23).

(2) Type B is used by the U.S. Army Air Forces. It consists of the basic M1 or AN-M2 Gun with M6 adapter, AN-M1 electric trigger, and M2 manual charger (fig. 23).

(3) Type C is used by the U.S. Army Air Forces. It consists of the basic M1 or AN-M2 Gun with the M7 adapter (with thread protector), AN-M1 electric trigger, and M2 manual charger (fig. 24).

(4) Type D is used by the U.S. Army Air Forces. It consists of the basic M1 or AN-M2 Gun with the M7 adapter (with M1 muzzle brake), AN-M1 electric trigger, and M2 manual charger (fig. 24).

(5) Type E is used by the U.S. Navy. It consists of the basic AN-M2 Gun with the AN-M1 adapter, AN-M1 electric trigger, and M1 hydraulic charger (fig. 24).

20-MM AUTOMATIC GUN M1 AND
20-MM AIRCRAFT AUTOMATIC GUN AN-M2

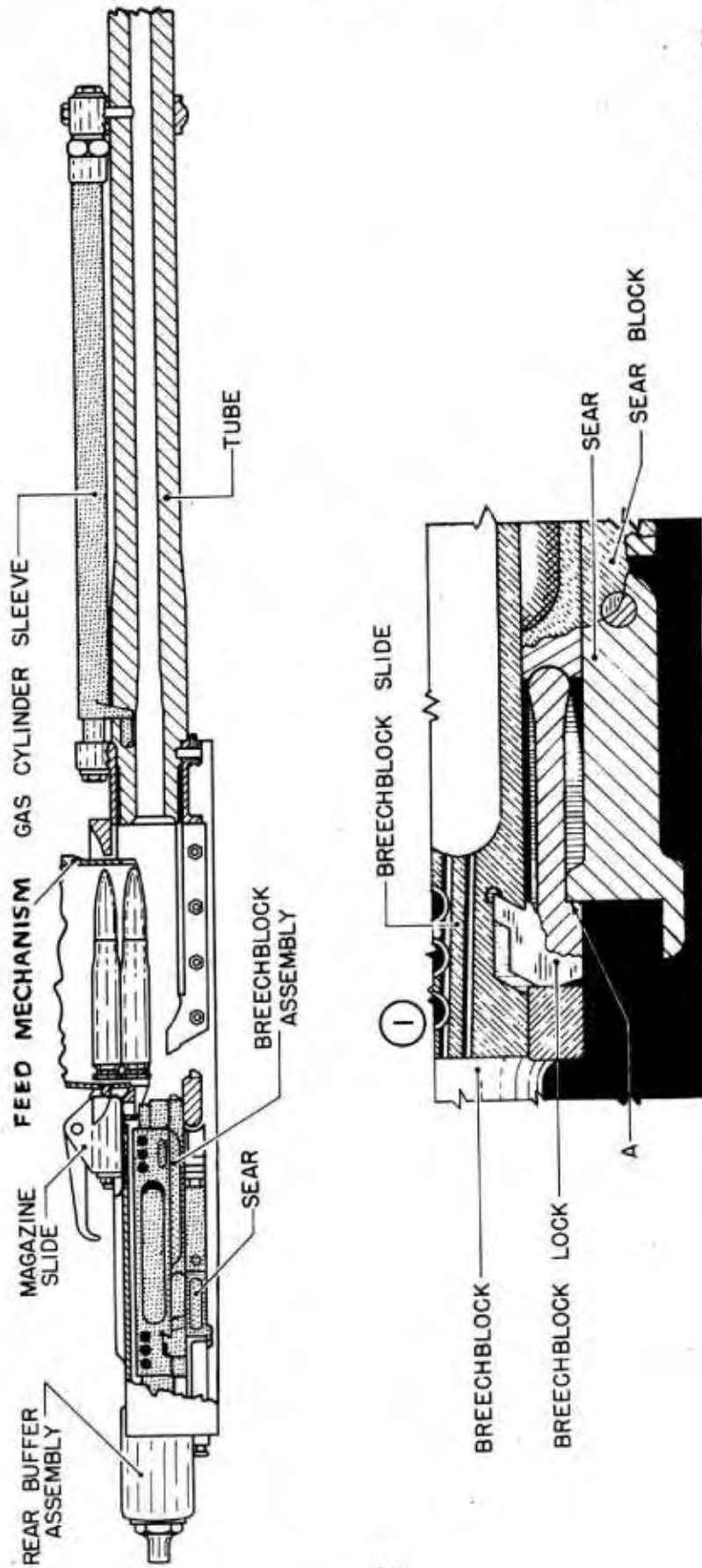

RA PD 24009A

Figure 22 — Action of Sear

DESCRIPTION, FUNCTIONING, AND INSTALLATION

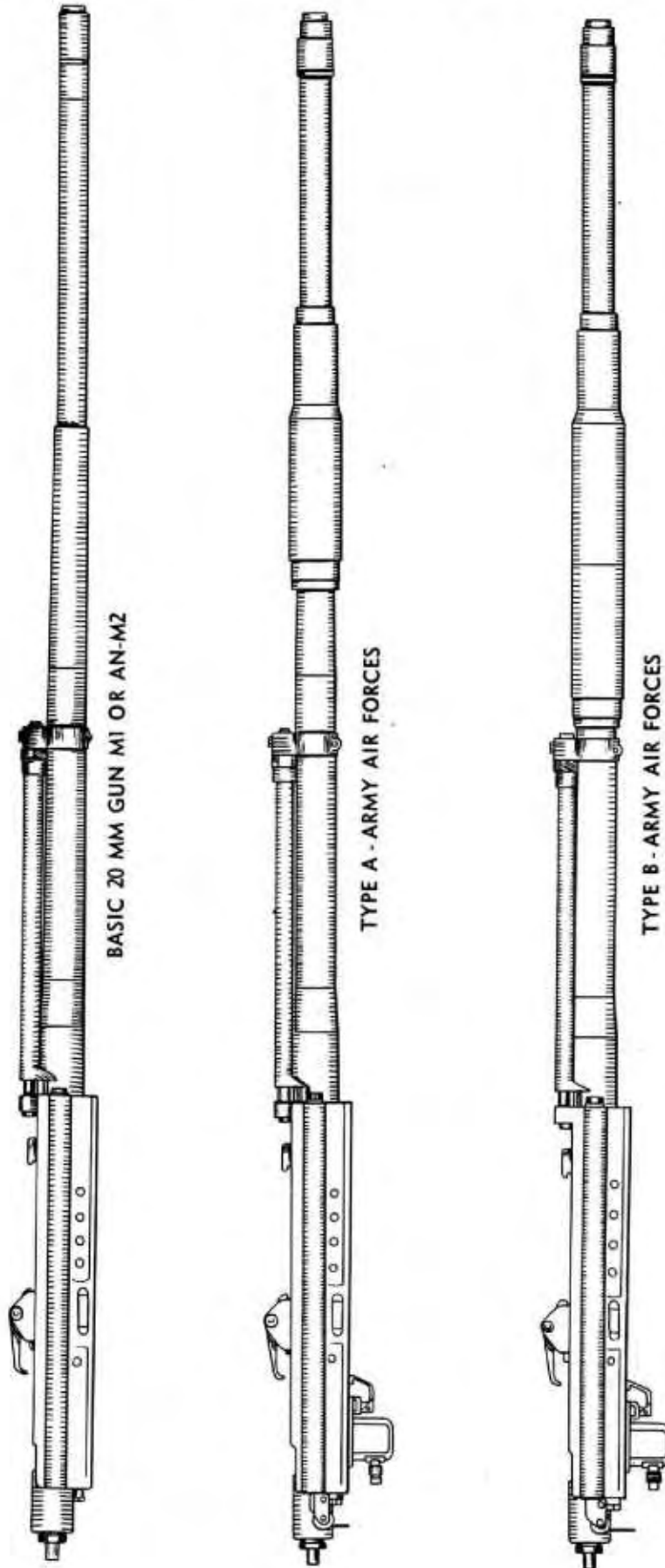

RA PD 66713

Figure 23 — Gun Type Designation Chart

20-MM AUTOMATIC GUN M1 AND
20-MM AIRCRAFT AUTOMATIC GUN AN-M2

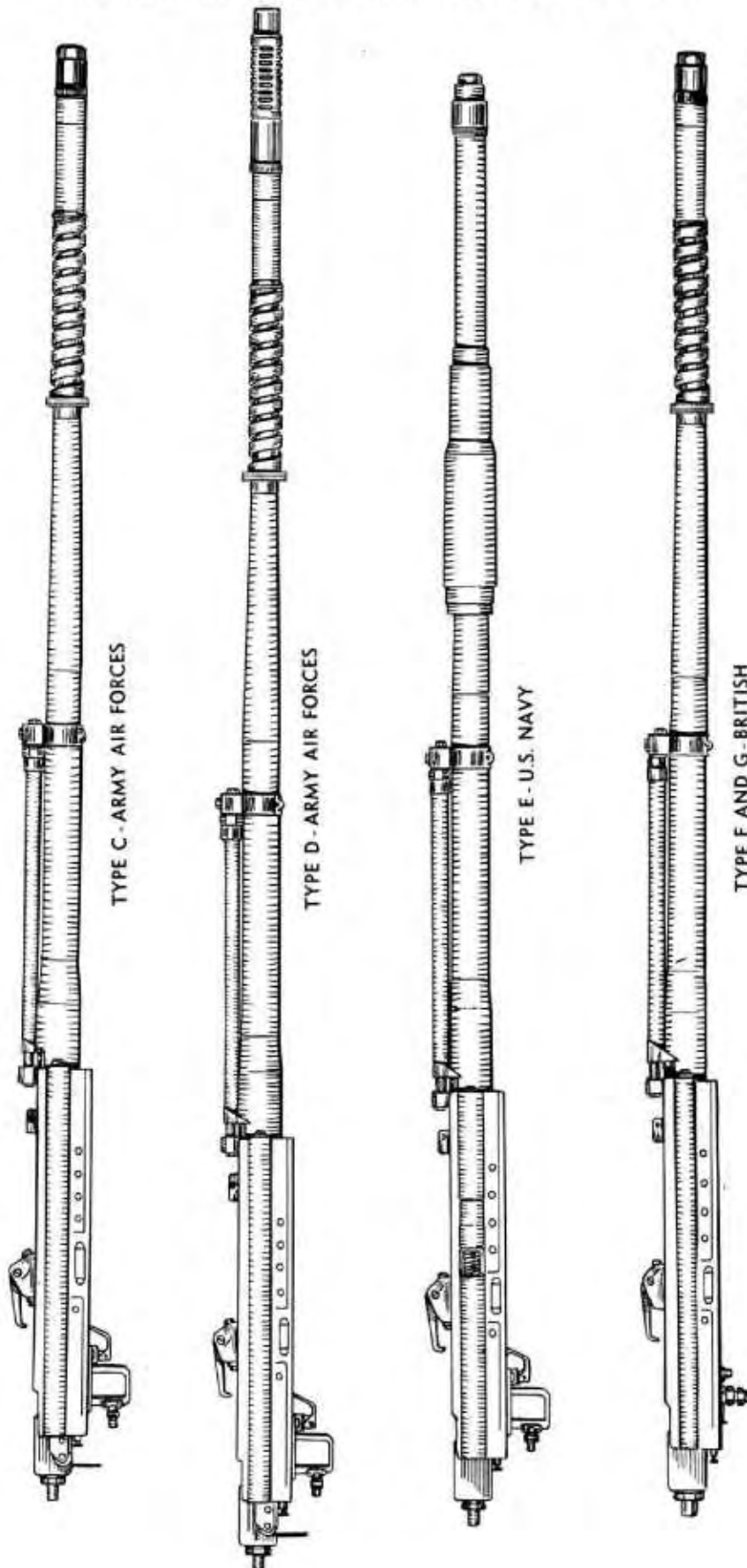

RA PD 66714

Figure 24 — Gun Type Designation Chart

DESCRIPTION, FUNCTIONING, AND INSTALLATION

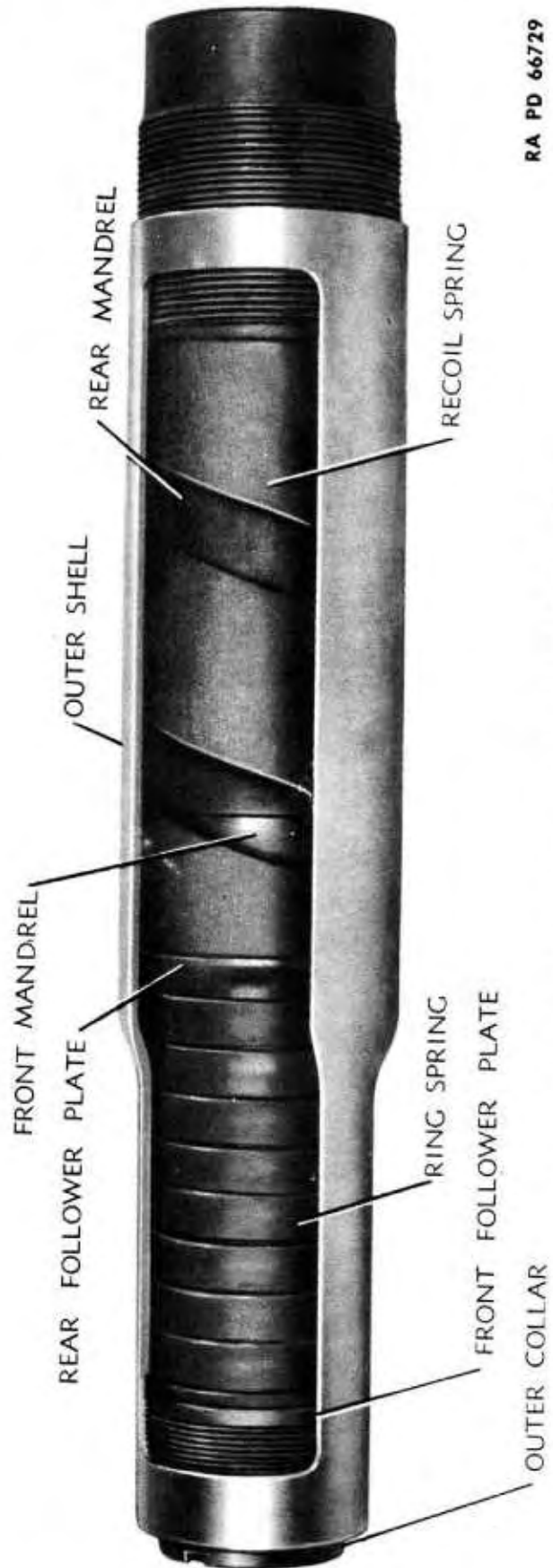

RA PD 66729

Figure 26 — Cutaway View of 20-MM AN-M1 Adapter

**20-MM AUTOMATIC GUN M1 AND
20-MM AIRCRAFT AUTOMATIC GUN AN-M2**

(6) The recovery of the springs returns the gun to battery. The adapter will act as a counterrecoil buffer if the gun should travel past its battery position. The ring springs will be compressed in the same manner as on the recoil motion of the gun, but the action of the parts will be exactly reversed to return the gun to battery. Thus, the energy of counterrecoil is absorbed and the gun is returned to battery.

b. Installation of 20-mm Adapter AN-M1.

(1) Installation of the adapter on the gun must be accomplished in conjunction with installation of the gun in an airplane. A mounting bearing assembly (figs. 27 and 28) is used to secure the adapter, and thus the gun, to the airplane structure. (The mounting bearing assembly is furnished by the airplane contractor.) It consists of a mounting bearing which screws onto the front mounting collar or the rear mandrel of the adapter, a bearing support, which is secured to the airplane structure, and a bearing support retaining screw which screws into the bearing support to secure the assembly. The bearing assembly can be mounted on the adapter in several different positions (fig. 29). When the correct point of mounting has been determined, the procedure described below should be followed:

(a) Slide the bearing sleeve onto the tapered portion of the tube with its smallest inside diameter forward. (The paint should be removed from the tube where the sleeve is installed to insure a tight fit.) Drive the sleeve onto the tube firmly with a soft hammer and tighten the three setscrews with the Allen hexagonal key wrench supplied with the adapter. Stake the setscrews in place and stone down any burs raised by staking so that the adapter will slide freely over the bearing sleeve.

(b) Screw the appropriate bearing tightly onto the adapter and stake it in place. If the rear mounting extension is used, it should be screwed tightly onto the adapter and staked in place at the V-joint.

(c) Install the adapter and assembled bearing in the bearing support, which is secured to the plane structure, and screw in the bearing support retaining screw handtight.

(d) Install the gun in the adapter by sliding the tube through the adapter until the shoulder on the tube abuts its flange in the adapter, at the same time engaging the flanges on the side of the receiver in the rear mounting yoke. Slip the tube sleeve over the end of the tube and secure it by screwing up the tube sleeve nut tightly with the special adapter combination wrench.

(e) After boresighting the gun, tighten the bearing support retaining screw into the bearing support with the special spanner wrench and secure it with locking wire.

DESCRIPTION, FUNCTIONING, AND INSTALLATION



Figure 27 — Typical Installations of 20-MM Adapter AN-M1 and Mounting Bearing



Figure 28 — Typical Bearing Assembly — Parts

20-MM AUTOMATIC GUN M1 AND
20-MM AIRCRAFT AUTOMATIC GUN AN-M2

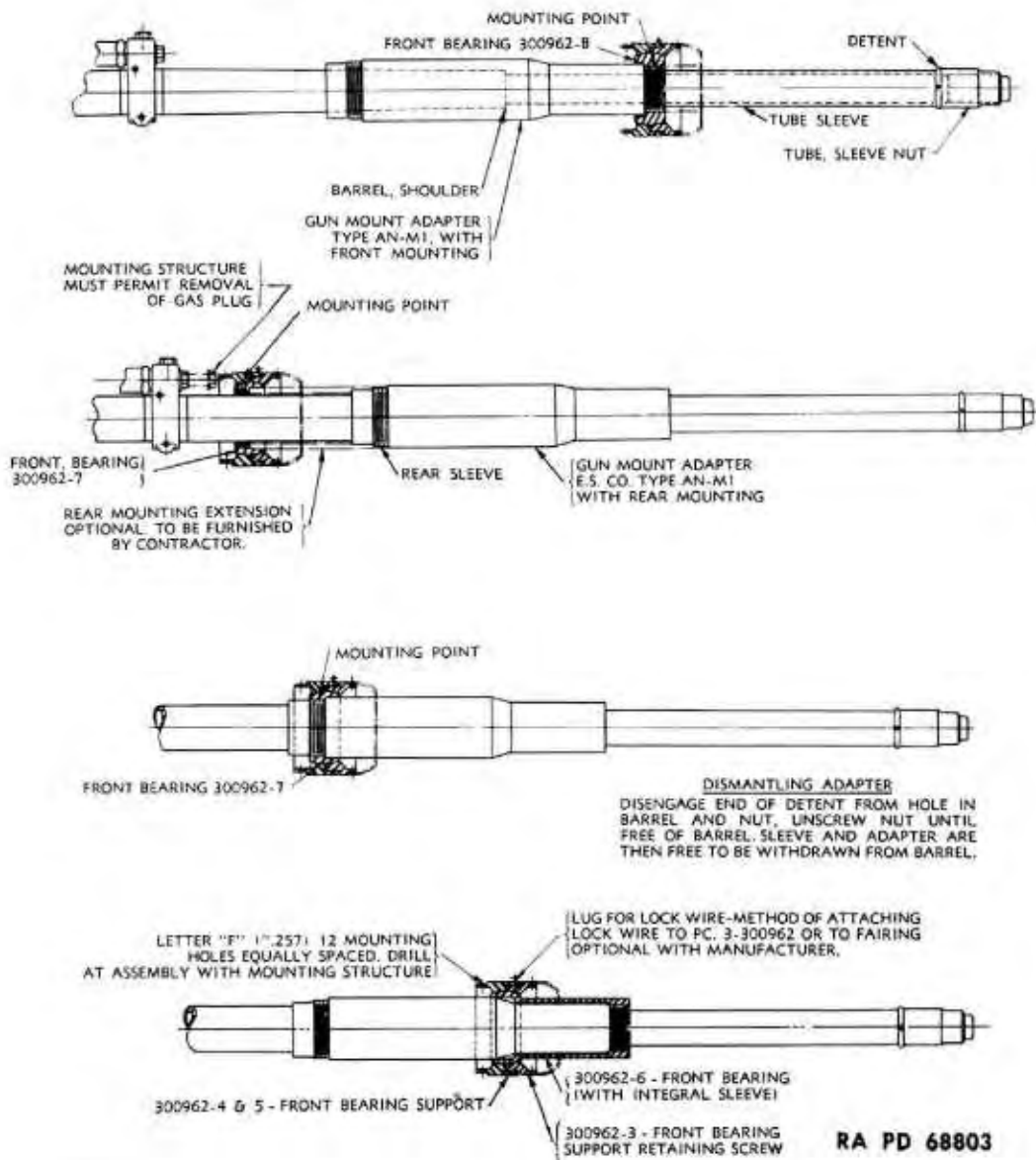

Figure 29 – Mounting Arrangements of 20-MM AN-M1 Adapter on Naval Installations

NOTE: The special adapter combination wrench and the special spanner wrench will be furnished in the 20-mm Aircraft Gun AN-M2 tool and accessory set.

(2) On some installations, when the feed and link chutes do not align with the feed mechanism, minor adjustments (about $\frac{3}{8}$ inch) of the position of the gun may be made by reversing the bearing on the adapter. This adjustment can be made with most bearings by unscrewing the bearing, turning it end for end, and reinstalling it.

(3) When removing a gun from an airplane, it is important to

DESCRIPTION, FUNCTIONING, AND INSTALLATION



RA PD 66732

Figure 30 — 20-MM Adapter M6

**20-MM AUTOMATIC GUN M1 AND
20-MM AIRCRAFT AUTOMATIC GUN AN-M2**

disconnect the feed and link chutes, if necessary, from the feed mechanism, remove the feed mechanism, disconnect the electric trigger and the hydraulic charger, and disconnect the magazine slide from the front mounting structure to which it is attached.

c. **Functioning of 20-mm Adapter M6 (fig. 30).** This adapter consists of the AN-M1 adapter as described in subparagraph a above, to which a rear extension body has been added in order to increase the over-all length of the adapter by $8\frac{1}{16}$ inches to suit some mounting requirements. The rear extension is not staked prior to shipment, in order that it may be removed in the field and the adapter converted to the AN-M1 model. This flexibility is provided to take care of cases where the mounting requirements are indefinite at the time of shipment or where they may be changed. Before the M6 adapter is installed, the rear extension body must first be staked by peening the outer shell of the adapter at a point adjacent to the V-shaped notch at the front edge of the extension body.

d. **20-mm Adapter M7 with Thread Protector (fig. 31).** The M7 adapter fits on the tube between the tube shoulder and the muzzle end. It consists of the dashpot piston, recoil spring with a recoil spring filler sleeve, recoil spring sleeve, a muzzle brake lock, and a thread protector. The short end of the piston abuts the shoulder on the tube while the long end rides against the rear of the recoil spring filler sleeve. The sleeve serves as a lining for the recoil spring. The recoil spring bears between the flanged recoil spring sleeve and a stationary mounting. In a typical installation (fig. 34) the front mounting has an inside circular shoulder which fits in front of the dashpot piston washer on the long end of the piston. In this manner the front face of the shoulder within the mounting serves as an abutment for the rear end of the recoil spring. The recoil spring sleeve is held in position by the muzzle brake lock and the thread protector. The muzzle brake lock is prevented from rotating by splines on the tube which mate with splines on the inside of the lock. The muzzle brake lock and thread protector are locked by mating teeth. As the gun recoils, the recoil spring is compressed against the shoulder in the mounting, thus reducing the force of recoil on the airplane structure.

e. **20-mm Adapter M7 with Muzzle Brake M1 (fig. 32).** This adapter is the same as that described in subparagraph d above, except that the thread protector has been replaced with muzzle brake assembly which counteracts some of the recoil. A typical installation is shown in figure 35. The muzzle brake assembly consists of a front ferrule, body assembly locking washer, and rear ferrule. The body assembly is composed of a sleeve and eight baffles staked in place. It has 36

DESCRIPTION, FUNCTIONING, AND INSTALLATION

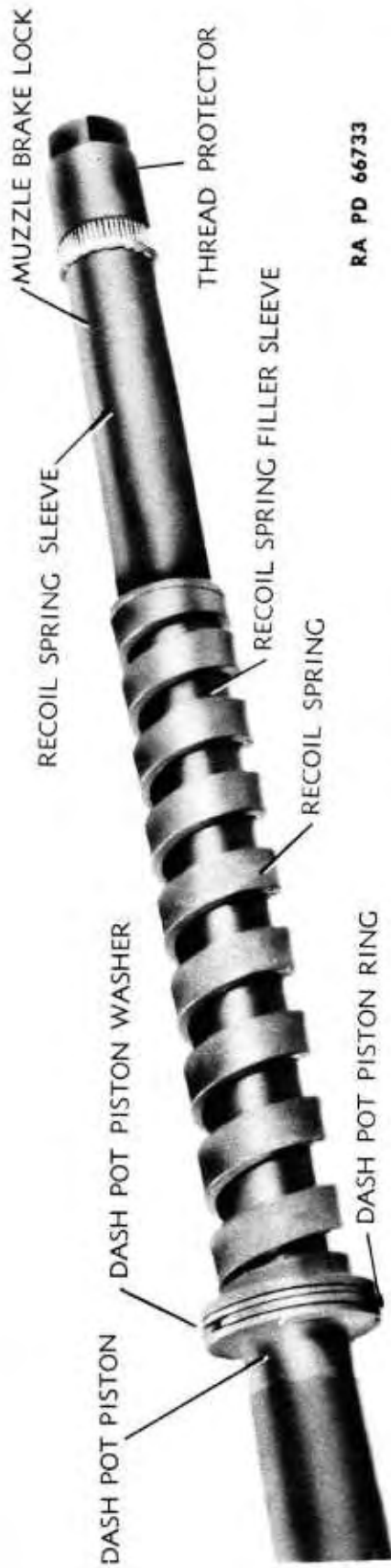

RA PD 66733

Figure 31 — 20-MM Adapter M7 with Thread Protector



RA PD 66734

Figure 32 — 20-MM Adapter M7 with Muzzle Brake

20-MM AUTOMATIC GUN M1 AND
20-MM AIRCRAFT AUTOMATIC GUN AN-M2

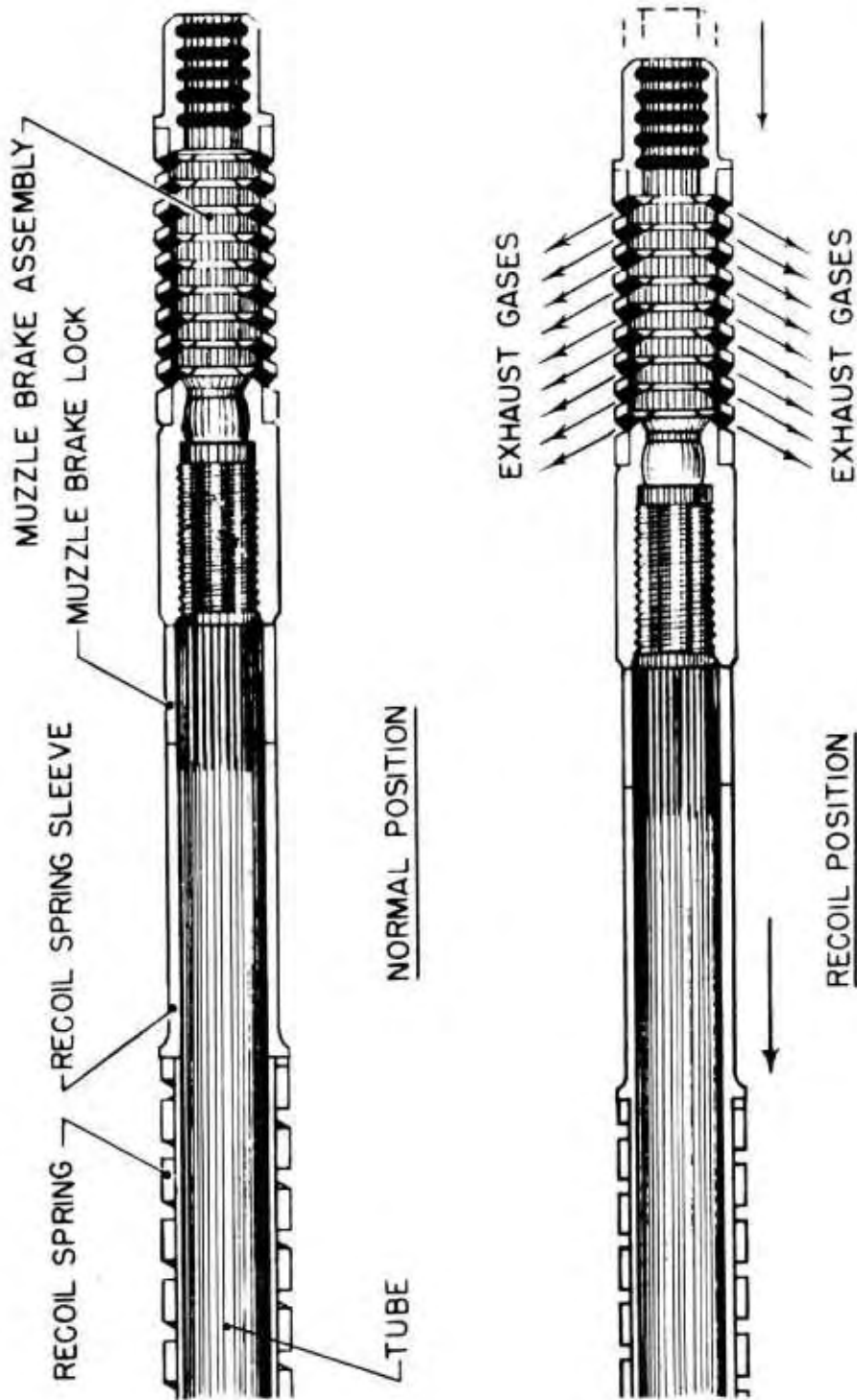

RA PD 23991A

Figure 33 — Action of Muzzle Brake

DESCRIPTION, FUNCTIONING, AND INSTALLATION



Figure 34 — Typical Installation of 20-MM Adapter M7 with Thread Protector



Figure 35 — Typical Installation of 20-MM Adapter M7 with Muzzle Brake M1

20-MM AUTOMATIC GUN M1 AND 20-MM AIRCRAFT AUTOMATIC GUN AN-M2

equally spaced ports cut at an angle of 45 degrees to the axis of the bore. This construction causes a portion of the blast gases to be deflected to the rear, thus absorbing about 35 percent of the recoil action (fig. 33). This adapter is used only with the 60-round magazine which does not utilize the recoil energy of the gun for its operation.

II. SEAR ACTUATING MECHANISMS.

a. Electric Trigger AN-M1 (figs. 36 and 37).

(1) The electric trigger AN-M1 is a remote-control device designed to fire the 20-mm guns in airplanes that are equipped with 24-volt electrical systems. Prior to standardization as the electric trigger AN-M1, this device was known in the Navy as the Electric Trigger Control Mk. 6 Model 1 and in the Army as G17 Solenoid.

(2) The electric trigger is attached to the receiver plate of the gun. It consists essentially of the mounting plate assembly and solenoid body.

(3) The solenoid body is secured to the mounting plate by means of dovetail connections and the cam lever lock mechanism. The mounting plate assembly is secured to the bottom of the receiver plate by six cap screws and provides a means for rapidly mounting and dismounting the electric trigger. The mounting plate assembly incorporates the following:

(a) A solenoid alinement pin which fits into the slotted hole in the base plate of the solenoid body so as to aline the sear shaft with the sear of the gun.

(b) A sear spring pin and spring, housed in the solenoid clamping stud and protruding on the inside face of the mounting plate to act on the sear which engages the breechblock lock.

(c) A cam surface on the inside face of the plate just to the rear of the sear spring pin which insures positive engagement of the sear with the breechblock lock by its camming action against the mating surface of the sear when the sear is forced forward against the sear buffer spring by the breechblock.

(4) The solenoid assembly consists of a solenoid mounted on a base plate by a yoke. A plunger and a pinned sear shaft extend through the base plate and are free to move within the solenoid. There is an AND 10066-10S-2P receptacle mounted on the rear end of the yoke for connecting the trigger to the electrical system of the airplane. The solenoid draws a maximum of eight amperes from a 24-volt system.

(5) When the solenoid is energized, a magnetic field is set up which acts on the solenoid plunger and on the attached sear shaft to

DESCRIPTION, FUNCTIONING, AND INSTALLATION



Figure 36 — Electric Trigger AN-M1 on Gun

20-MM AUTOMATIC GUN M1 AND
20-MM AIRCRAFT AUTOMATIC GUN AN-M2

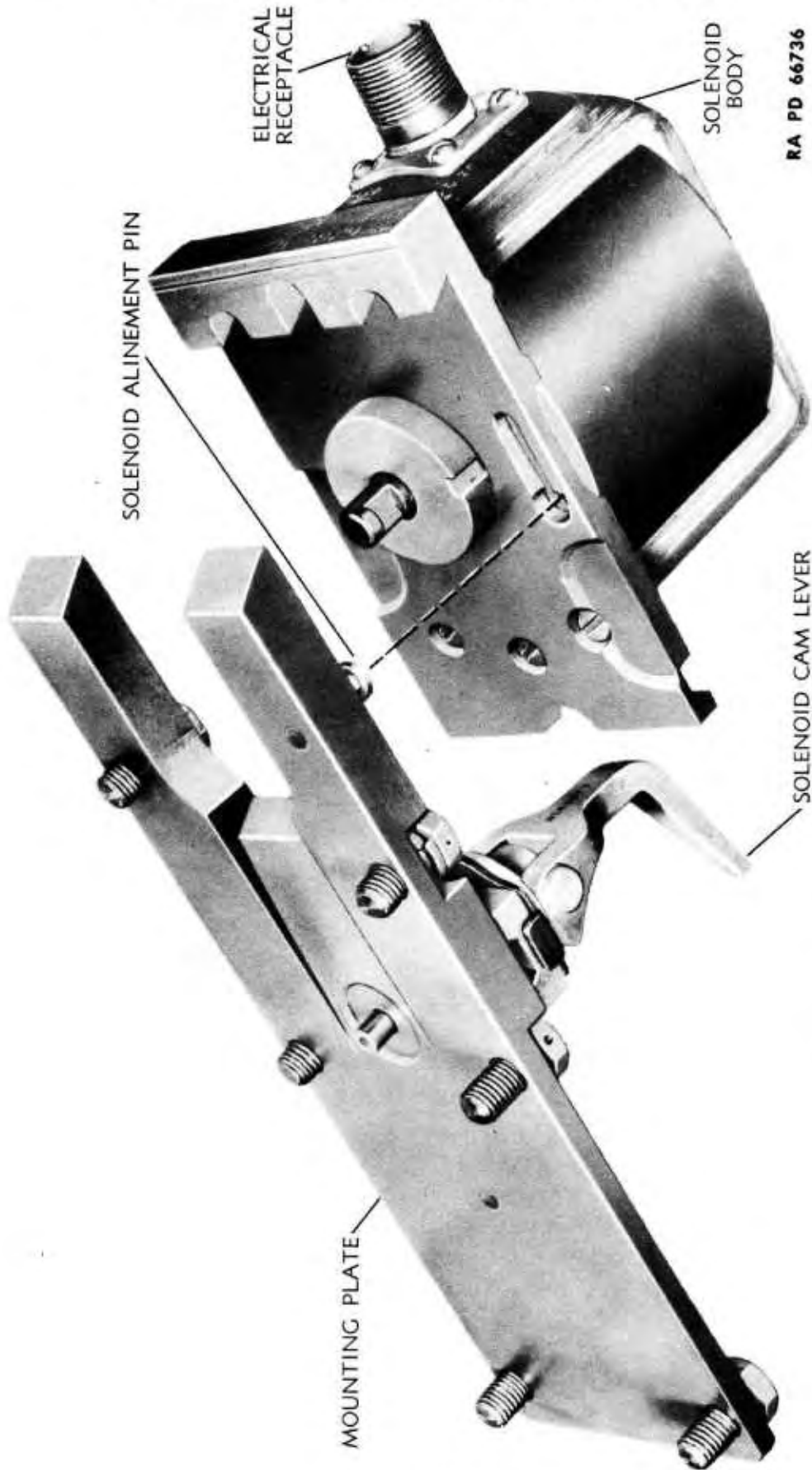

Figure 37 — Electric Trigger AN-M1 — Installation

DESCRIPTION, FUNCTIONING, AND INSTALLATION

draw them into the solenoid against spring tension with a force of approximately 75 pounds. This force is large enough so that the gun will be fired regardless of the altitude of the plane in which the gun is installed.

b. Installation of Electric Trigger AN-M1 (fig. 37).

(1) Secure the mounting plate to the receiver plate with the six cap screws provided with the gun, using lock washers on the two rear-most screws. Lock the other four screws with locking wire. Proper lock wiring of this component is essential and should not be neglected for any reason.

(2) Attach the solenoid by raising the locking lever and slipping the solenoid on from the rear in such manner that the locking shoulder is slipped beneath the clamp which is actuated by the locking lever.

(3) Rotate the locking lever until the end abuts the plate and lock wire to the small screw in the plate.

(4) Connect solenoid to the electrical system of the airplane by mating the male and female electrical receptacles.

c. Sear Mechanism M1 (fig. 38). The sear mechanism is secured to the receiver plate by means of six cap screws; the two cap screws nearest the rear end require lock washers, and the other four cap screws and the sear housing are locked by locking wire. A hardened insert is fitted into a recess on the inside face of the plate. The purpose of this insert is to assure positive engagement of the sear with the breechblock lock by its camming action against the mating surface of the sear as the latter is forced forward against the sear buffer springs. To the front of the insert, the plate is drilled and tapped to receive the sear spring housing with the spring and plunger. The sear spring forces the sear spring plunger upward against the sear so that the latter can engage the breechblock lock. To the rear of the insert, the plate is drilled and tapped to receive the bowden shaft housing nut. The bowden connection shaft is a shouldered cylindrical shaft which slides vertically within the spring in the bowden connection nut. The upper end of the shaft has lugs for engaging the forked end of the sear. The lower end of the shaft is drilled and slotted for connecting the bowden control cable. A groove in the shaft is for engagement with the safety trigger pin which is operated by the safety lever. The pin has two notches which, in conjunction with the spring and ball, hold the lever in the "SAFE" or "FIRE" position. The lower end of the bowden shaft housing nut has the bowden connection nut which houses the inner and outer bowden connection bushings.

20-MM AUTOMATIC GUN M1 AND
20-MM AIRCRAFT AUTOMATIC GUN AN-M2

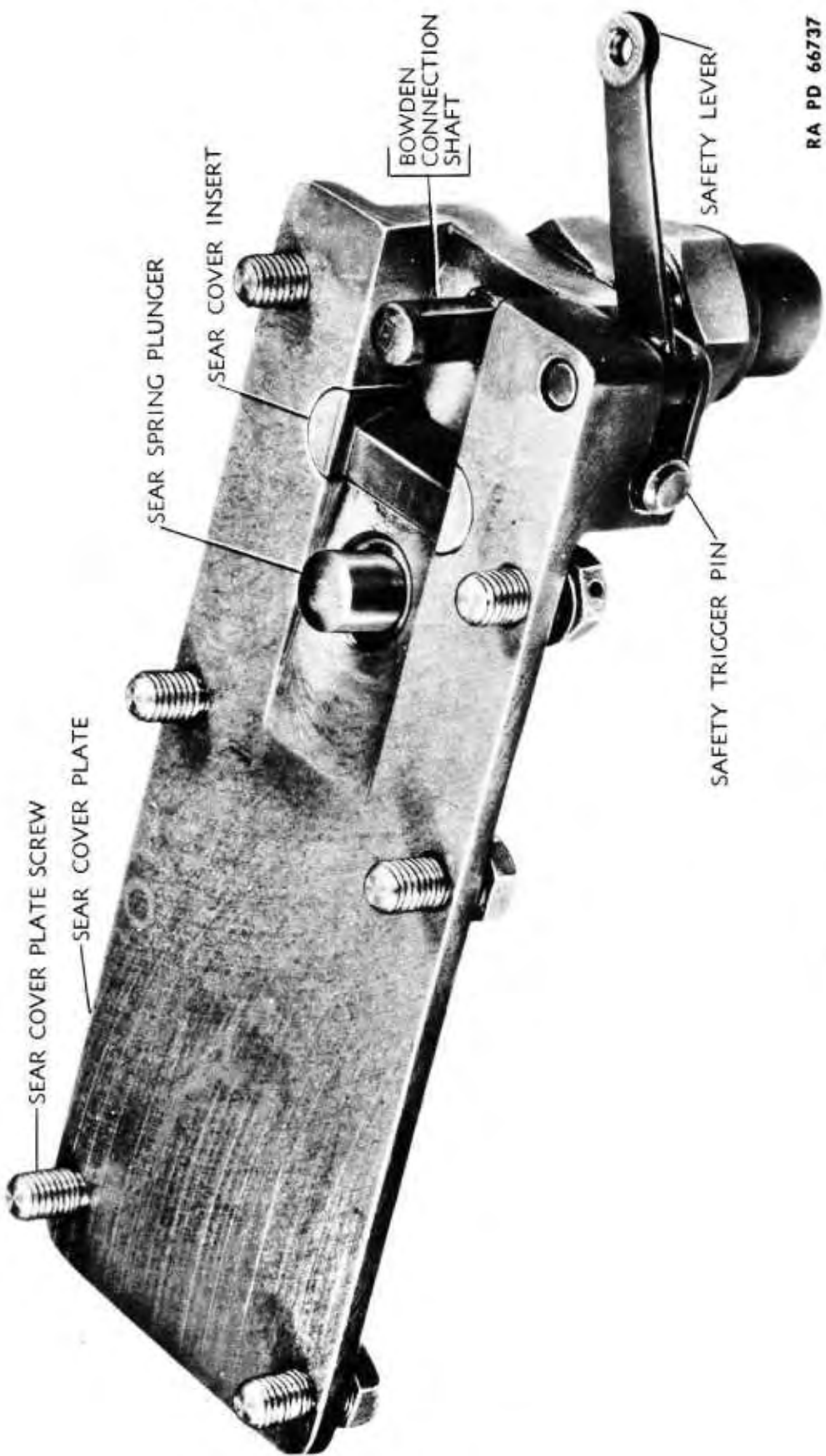

RA PD 66737

Figure 38 — Sear Mechanism M1

DESCRIPTION, FUNCTIONING, AND INSTALLATION**12. CHARGERS.****a. Functioning of Hydraulic Charger M1 (fig. 39).**

(1) Naval installations of the 20-mm Aircraft Gun AN-M2 are equipped with the 20-mm hydraulic charger M1 which provides a means of charging or safetying by remote control 20-mm guns in an airplane. The charger consists of a spring guide assembly, a piston spring, and a cylinder and piston assembly, all of which are assembled within the cylindrical charger housing on the right-hand side of the gun. A charger housing end is attached to the spring guide by a press fit, and the assembly is inserted in the charger housing of the gun from the rear, with the slotted portion of the housing end toward the bolt of the gun, to allow clearance for the charging stud as the bolt is removed from the receiver. The spring guide assembly is secured to the cylindrical charger housing by a taper pin and the housing end serves as a stop for the travel of the charger piston. The piston return spring fits over the spring guide in the rear end of the housing and fits within the cylinder and piston assembly.

(2) The cylinder and piston assembly consists of a piston tube fitted within a highly polished cylinder. The forward end of the cylinder is threaded externally so that it can be screwed into the forward end of the charger housing, using a special spanner wrench furnished with the hydraulic charger. A piston head assembly which fits tightly in the cylinder, is secured to the forward end of the piston tube. It consists of two composition V-shaped packings held in place by a seat, a follower, and a castle nut (fig. 40).

(3) A cylinder end adapter is screwed into the forward end of the cylinder assembly to provide a means of connecting the charger to the hydraulic system of the airplane.

(4) When the charger control valve is actuated, hydraulic fluid is forced into the cylinder chamber forcing the piston tube to the rear. The piston contacts the lug on the bolt after a short rearward motion, and carries the bolt with it during the remainder of the rearward movement. The piston carries the bolt rearward far enough so that the sear can lock the bolt in the rear position. Further movement of the piston tube to the rear is stopped by the cylinder end housing. During this rearward motion of the piston tube, the hydraulic pressure in the system increases to about 350 to 600 pounds per square inch, depending on the setting of the release valve in the charger control valve.

(5) After the piston tube has completed the rearward motion, the pressure in the system continues to increase to about 800 to 1,100 pounds per square inch, depending upon the setting of the release valve in the charger valve. Pressure in the system actuates the release valve

20-MM AUTOMATIC GUN M1 AND
20-MM AIRCRAFT AUTOMATIC GUN AN-M2

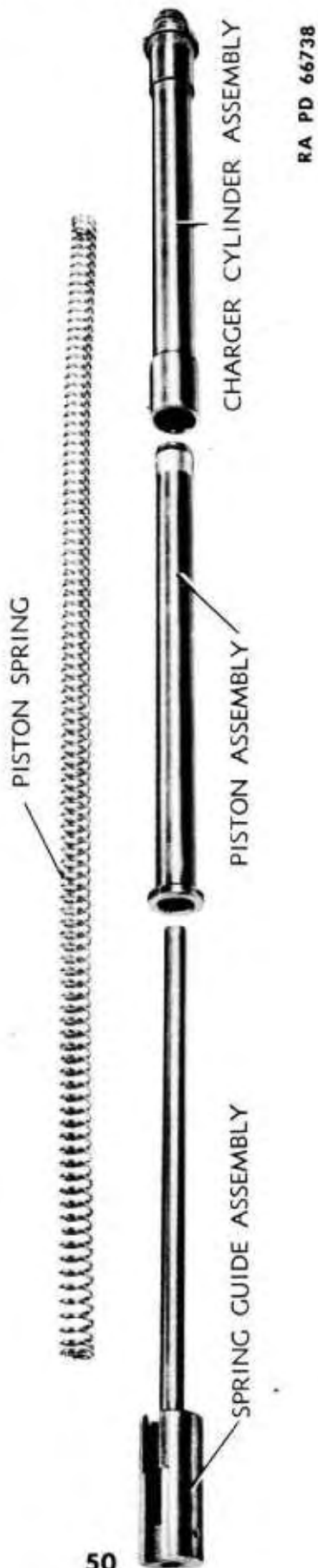

Figure 39 — Hydraulic Charger M1

DESCRIPTION, FUNCTIONING, AND INSTALLATION

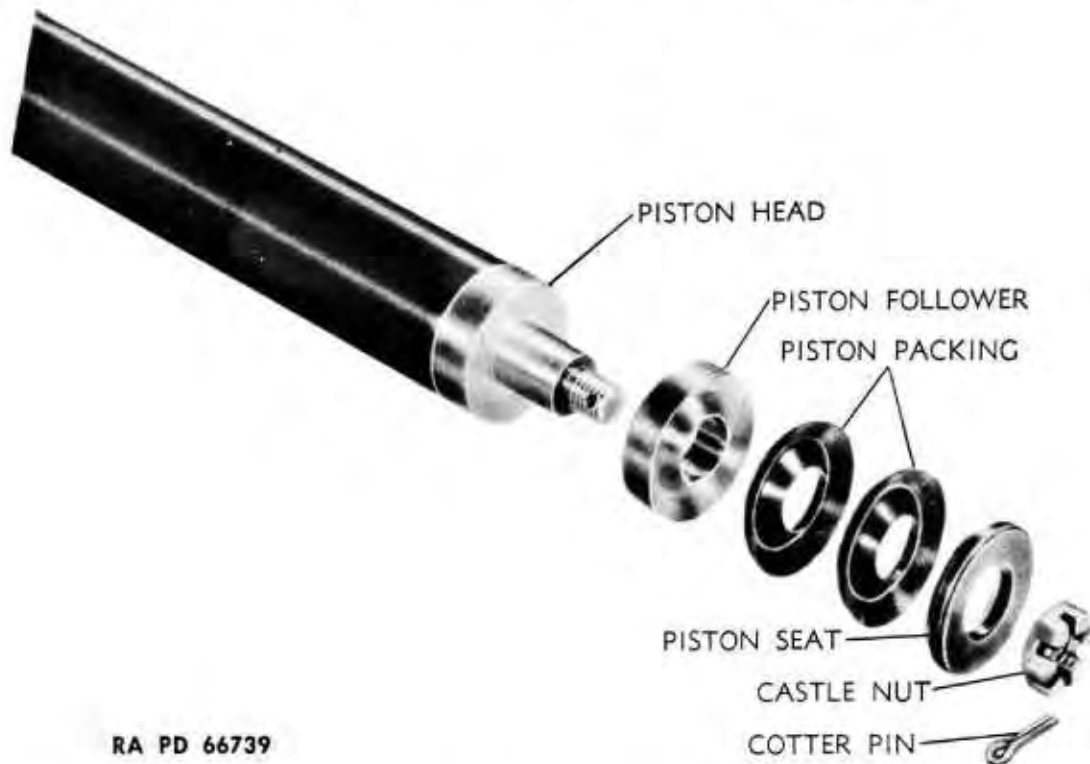

Figure 40 — Piston Head Details

in the charger control valve, resulting in the control valve handle "popping out." If the control valve is set on "SAFE," the hydraulic fluid is locked in the charger system, thus holding the piston tube and the bolt in the rear position. If the control valve is set on "FIRE," the hydraulic fluid in the charging system can flow into the return line and to the hydraulic fluid reservoir. When the hydraulic fluid in the cylinder is released to the return line in the airplane hydraulic system, the spring in the charger forces the piston tube forward to its original position ahead of the lug on the bolt, thus leaving the bolt free to move forward and fire if the trigger is actuated. If the control valve is originally set on "SAFE," a rotation of the control valve handle to the position marked "FIRE" will result in releasing the pressure in the charging cylinder and permit the gun to fire if the trigger is pressed.

CAUTION: Do not stand in back of the gun when the hydraulic charger is actuated. If the taper pin becomes loosened, the high pressure acting on the charger housing end may force the housing end out of the housing at high velocity and result in injury to personnel.

b. Installation of Hydraulic Charger M1. Guns may be shipped with the hydraulic charger M1 installed in them. If the charger is shipped separately, or if a new charger is to be installed in the gun, the following procedure should be followed:

20-MM AUTOMATIC GUN M1 AND
20-MM AIRCRAFT AUTOMATIC GUN AN-M2



Figure 41 — Manual Charger M2



Figure 42 — Manual Charger 20-MM M2 — Installation

DESCRIPTION, FUNCTIONING, AND INSTALLATION

(1) Insert the spring guide in the piston spring and slide the assembly into the rear of the charger housing with the slotted portion of the spring guide toward the breechblock assembly to allow for clearance of the charging stud as the breechblock assembly is removed from the receiver.

(2) When the hole in the spring guide is lined up with the holes in the charger housing of the gun, the hole should be reamed through for a No. 3 taper pin.

(3) Drive the taper pin into the hole firmly, and stake the pin securely to the charger housing.

(4) Place the cylinder and piston assembly over the spring, which will protrude from the front end of the charger housing. Push the assembly into the charger housing and screw the threaded end of the cylinder into the housing with the special spanner wrench provided with the charger.

NOTE: When removing the charger from the gun, remove the cylinder and piston assembly first. When removing the cylinder and piston assembly, care must be taken to prevent the assembly from flying out under the action of the piston spring.

(5) Connect the charger to the hydraulic system of the airplane.

c. Functioning of Manual Charger M2 (fig. 41). The manual charger M2 was previously designated as the B6 charger by the U.S.A.A.F. The charger consists essentially of a flanged charger slide for engaging and retracting the breechblock, a slide spring for returning the slide to its forward position, and a spring guide which closes the rear end of charger housing. The slide is actuated manually by pulling the slide cable. The cable is anchored in the slide plug in the front of the slide and passes out through the spring guide and over a pulley. The front of the slide spring rests in the slide and the rear fits around the slide spring guide. The front of the charger housing is closed by a charger housing plug. As the cable is pulled against the spring pressure, the slide moves to the rear, engaging the projection on the right-hand breechblock slide and retracting the breechblock. In the fully retracted position, the sear will engage the breechblock lock and hold the breechblock assembly until the gun is fired. The cable is then released, thus allowing the spring to return the slide to its front position. Thus, when the firing mechanism is actuated, the bolt will move forward at its normal rate unimpeded by the slide.

d. Installation of Manual Charger M2 (fig. 42).

(1) Before installation of manual charger, the breechblock must be removed from gun. To facilitate installation, the M2 manual charger should be assembled before placing in charger housing of gun. To do

20-MM AUTOMATIC GUN M1 AND
20-MM AIRCRAFT AUTOMATIC GUN AN-M2

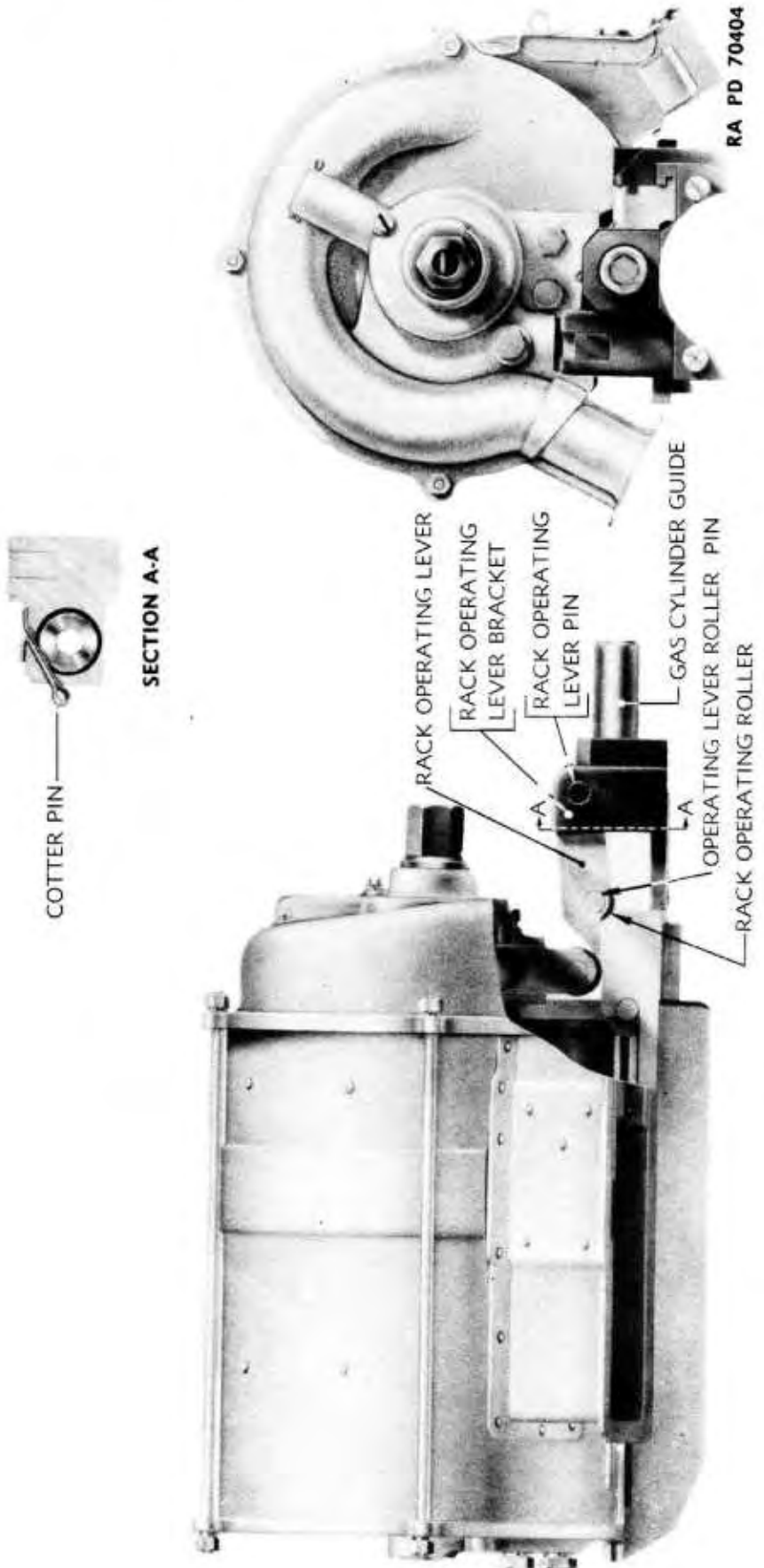

Figure 43 - 20-MM Feed Mechanism AN-M1 and Charging Cam Assembly

DESCRIPTION, FUNCTIONING, AND INSTALLATION

this, force cable out from end of spring guide as far as possible. Slip slide spring over cable and on to the guide. Hold guide plug and guide against a solid support and compress the spring on the guide. Slip the charger slide over the spring and guide until the swaged ball fitting protrudes from front end of the slide. Install the slotted swaged slide plug over the cable at swaged ball end and release the spring gradually.

(2) To install in the gun, screw the charger housing plug into the front end of the charger housing. With charger slide and compressed spring on spring guide, pull cable out through pulley end of slide until slide plug seats itself at front end of slide. Holding the cable taut at the guide plug to keep the spring compressed, insert the charger into the charger housing of the gun. Secure guide by screwing guide screw (with spacer assembled) through hole in side of charger housing and into guide plug.

13. FEED MECHANISMS.

a. 20-mm Feed Mechanism AN-M1.

(1) DESCRIPTION OF 20-MM FEED MECHANISM AN-M1 (figs. 43, 44, 45, and 46).

(a) The 20-mm feed mechanism AN-M1 is a device which utilizes the recoil energy of the gun to feed rounds to the gun. The rounds are assembled into a belt with links, and the function of the feed mechanism is to draw up the belt to the gun, separate the rounds from the links, and feed the rounds, one at a time, into the breech of the gun. There are two distinct mechanisms, one for right-hand and one for left-hand feeding.

(b) The feed mechanism consists of a cylindrical metal case, the ends of which are closed by front and rear covers held by three tie rods. Inside the case is a rotatable central shaft supported by the covers. Three sprockets, with hubs keyed on the shaft, form an assembly which rotates as a whole. A link ejector bracket is mounted on the hub of the front sprocket. A front feed lever, carrying a last round retainer, is mounted on the hub of the center sprocket. A rear feed lever is mounted on the hub of the rear sprocket. Riveted to the front sprocket is a driving spring case within which is a spiral driving spring. A rack mounted in the front cover engages a ratchet actuating segment which rotates a tensioning ratchet to maintain the tension of the driving spring. A pawl in the front cover engages teeth on the tensioning ratchet to prevent unwinding.

(c) The case is cylindrical with three circumferential guides riveted inside. The belt guide is riveted over a slot in the case and permits a feed chute to be attached. Three belt guide packings, which serve as link guides, are riveted inside the belt guide. The link chute is riveted

20-MM AUTOMATIC GUN M1 AND
20-MM AIRCRAFT AUTOMATIC GUN AN-M2

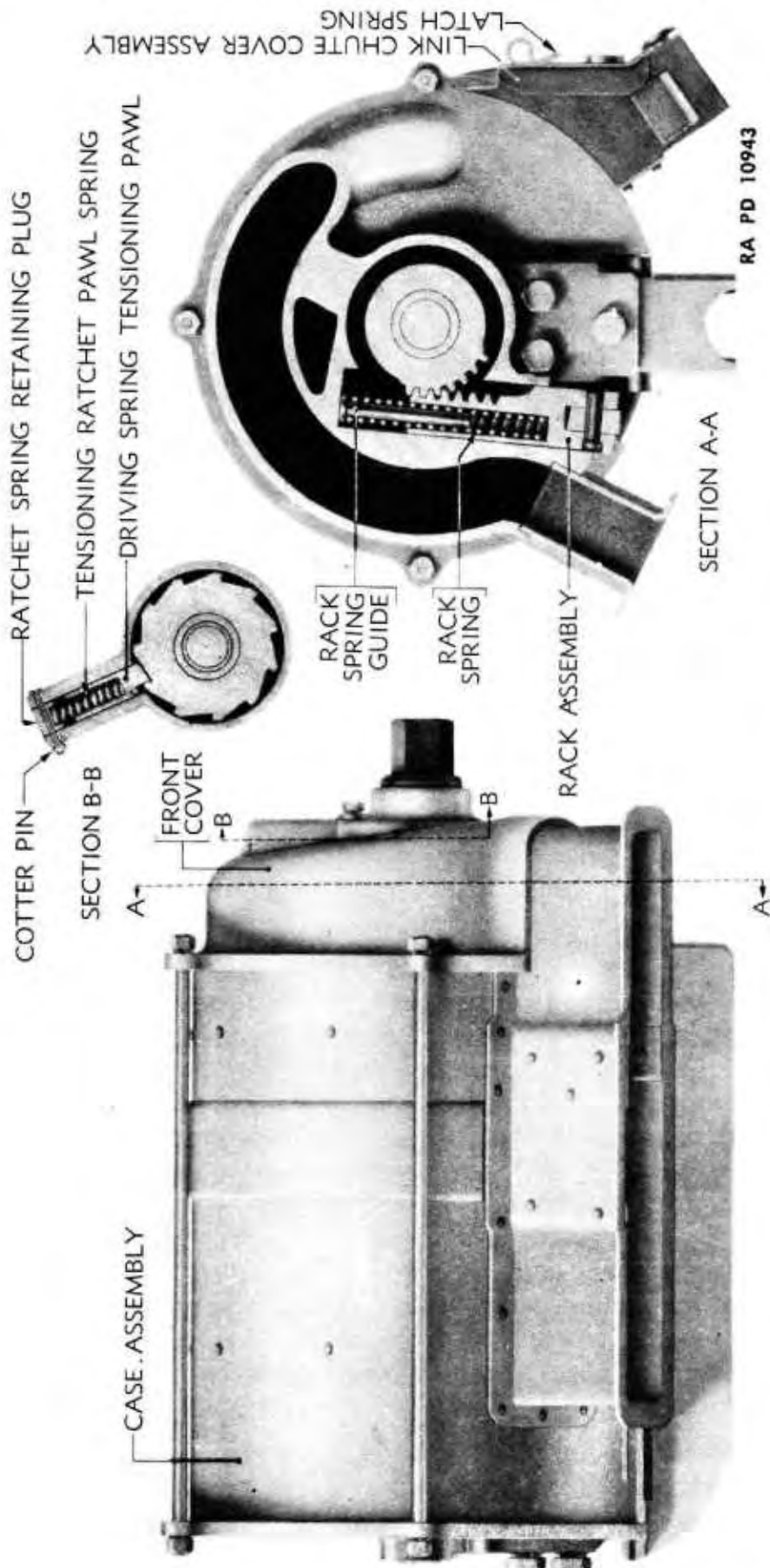

Figure 44 — 20-MM Feed Mechanism AN-M1 — Front Cover Sectional Views

DESCRIPTION, FUNCTIONING, AND INSTALLATION

over a slot in the case and is provided with a cover. The cover is hinged to one of the tie rods and is held in place by side flanges on the chute. A latch is riveted to the cover and retains it in the closed position by engaging a stud on the outer end of the chute. A ramp is secured inside the cover, and a flat spring is riveted to the inner end of the ramp to facilitate ejection of the links. A lug welded to each side of the link chute permits attachment of the link chute to convey the links away from the gun.

(d) The mouth has a vertical lug at each end which secures the front and rear covers by three screws on each end. Grooves along each side of the mouth receive the edges of the case assembly. At the rear of the mouth is a shoulder to be engaged by the magazine latch. On each side, at the front of the mouth, is a pin to engage the hook-shaped projections of the magazine slide. A small lip along part of the lower edge of the mouth supports the round in the path of the breechblock until it is pushed forward by the breechblock.

(e) In the front cover is formed the cam groove by which the noses of the rounds are guided and forced back as they are carried through the mechanism. A hollow boss on the front cover accommodates the driving spring mechanism, and recesses are provided for the actuating rack and pawl. A cartridge ramp is riveted to the rear cover and limits the rearward movement of the rounds. A pin protruding from the rear cover serves as the feed lever stop.

(f) The driving mechanism consists of a rack with a spring and spring guide, a ratchet actuating segment, a tensioning ratchet with spring actuated pawl, a ratchet thrust spring, a driving spring hub, and a driving spring.

(g) The rack has six teeth to engage the teeth on the actuating segment. A hole in the upper end accommodates the rack spring with its guide. At the lower end of the rack is a roller which rotates on a pin, the ends of which are peened. A longitudinal slot in the rack is engaged by the rack retaining screw. Another slot diametrically opposite the other makes it possible to use the rack for either a right-hand or left-hand feed mechanism. The actuating segment fits on the driving spring hub, and is housed inside the hollow boss of the front cover. Eight teeth on a part of its periphery engage with the teeth of the rack. On the front face of the segment there are 11 ratchet teeth to engage with the ratchet teeth of the tensioning ratchet. A ratchet thrust spring forces the actuating segment against the tensioning ratchet to maintain contact between the two sets of teeth.

(h) The tensioning ratchet fits over the front end of the driving spring hub, to which it is secured by a pin. The driving spring hub rotates on the front end of the shaft, and the boss of the tensioning

20-MM AUTOMATIC GUN M1 AND
20-MM AIRCRAFT AUTOMATIC GUN AN-M2

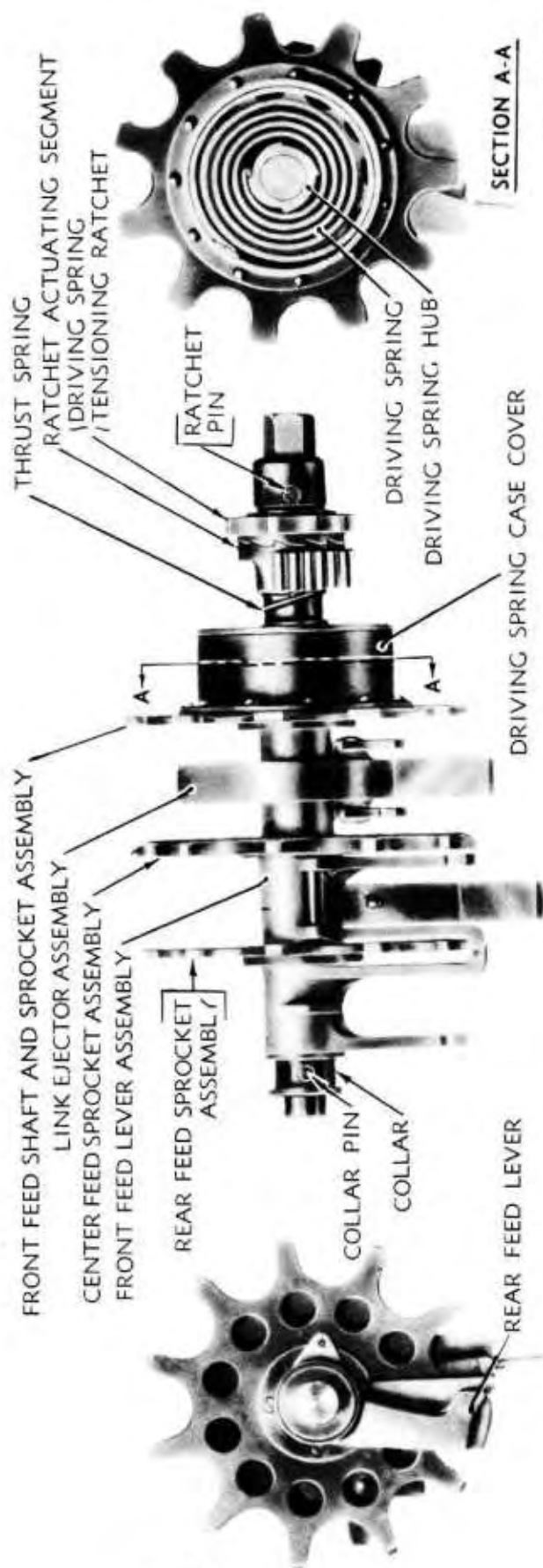

RA PD 70393

Figure 45 — 20-MM Feed Mechanism AN-M1 with Cover Removed

DESCRIPTION, FUNCTIONING, AND INSTALLATION

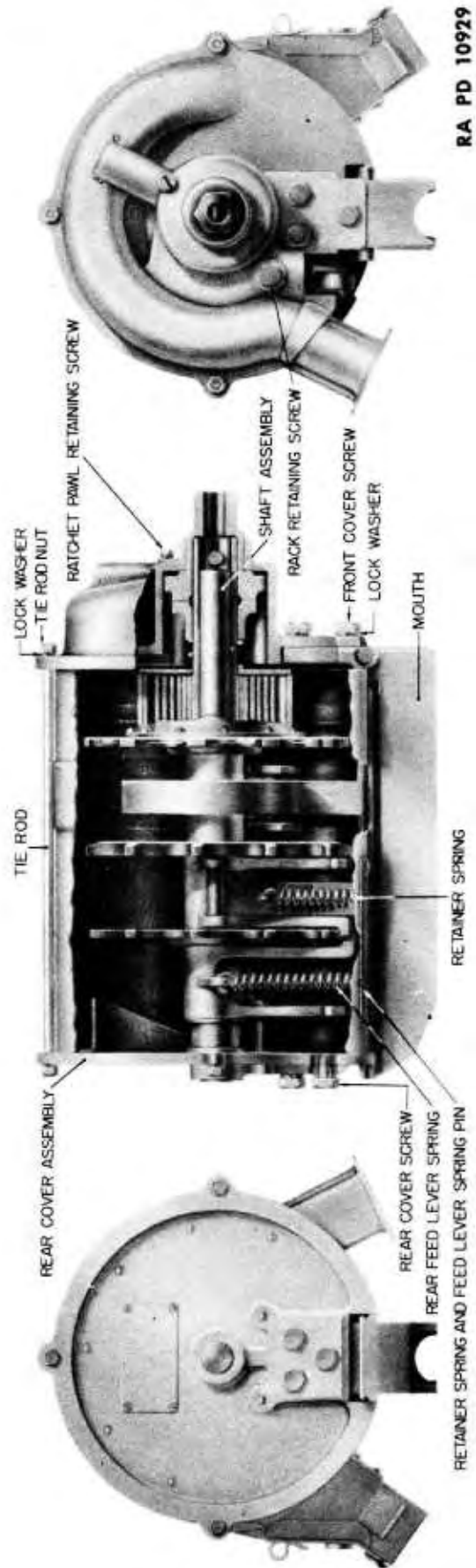

Figure 46 — 20-MM Feed Mechanism AN-M1 — Sectioned View

**20-MM AUTOMATIC GUN M1 AND
20-MM AIRCRAFT AUTOMATIC GUN AN-M2**

ratchet rotates in the bearing formed in the front cover. The tensioning ratchet thus forms the front bearing for the shaft, but each is free to rotate independent of the other. The boss of the tensioning ratchet projects through the front cover and is hexagonal to permit use of a wrench for applying the initial tension to the driving spring. One of the flat faces of the pawl is extended partly along the side and engages the flat portion of the retaining screw, thus preventing the pawl from rotating while allowing it to reciprocate.

(i) The driving spring hub has four ratchet teeth on the periphery, any one of which can engage the inner end of the driving spring. The driving spring is a flat coiled spring. At the inner end it is bent to engage one of the four teeth on the driving spring hub. The outer end engages the driving spring case.

(j) The front, center, and rear sprockets are provided with hubs which are keyed to the shaft. Each sprocket has 11 teeth. The driving spring case is riveted to the front face of the front sprocket. The center sprocket prevents axial movement of the links while the rounds are pushed out of them towards the rear.

(k) The link ejector (fig. 47) consists of two four-toothed sprockets rotatably mounted on a bracket which is maintained stationary between the front and center sprockets. The sprockets are mounted on a square shaft. A spring-actuated plunger is located in the bracket and bears against the flats of the shaft to hold the link ejector in the correct position to be engaged by each round. The link ejector bracket is mounted on the hub of the front feed sprocket, which is free to rotate within the bracket. To prevent the bracket from rotating, a forked arm engages the top edge of the mouth on the belt feed side. The upper side of the arm is curved and helps to guide the rounds into the mouth.

(l) The front feed lever has two arms and is mounted on the hub of the center sprocket. The front arm has a projection to push on the upper side of the second round in the mouth, and the rear arm has an extension which projects towards the rear and mates with a projection on the rear feed lever. Normally the two feed levers operate as one unit, but one can turn relative to the other in one direction, thus preventing damage if a round should enter the mouth obliquely. Two lugs are formed on the front feed lever, the last round retainer being hinged between them.

(m) The purpose of the last round retainer is to prevent the last round from dropping all the way down into the mouth of the feed mechanism. If the last round should drop into the path of the bolt, a stoppage would result. The last round retainer is a flat lever which projects into the mouth. On its outer side is a stud to which the last round re-

DESCRIPTION, FUNCTIONING, AND INSTALLATION

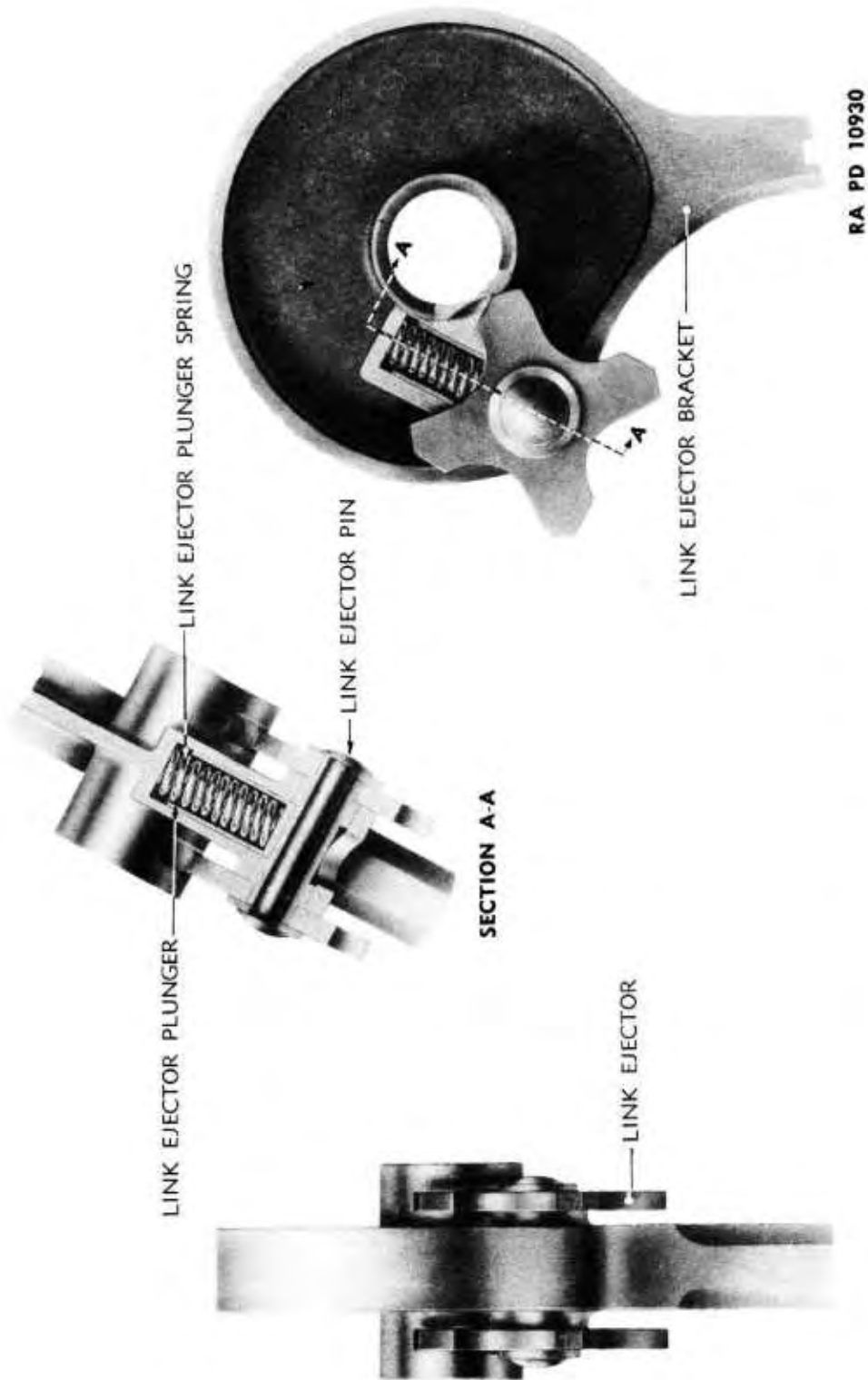

RA PD 10930

Figure 47 — Link Ejector Assembly

20-MM AUTOMATIC GUN M1 AND 20-MM AIRCRAFT AUTOMATIC GUN AN-M2

tainer spring is secured at one end. The other end of the spring is formed into a loop which passes through a hole in the case and is secured by a pin. The spring holds the retainer against the side of the mouth and tends to pull the retainer further into the mouth. When the last round leaves the sprocket, the feed lever moves up against the stop in the rear cover, moving the retainer into the mouth. This prevents the last round from dropping all the way down into the mouth.

(n) The rear feed lever has two arms and is mounted on the hub of the rear sprocket. The rear short arm has a projection at its lower end to steady the rounds in the mouth. Incoming rounds force the lever away from the stop in the rear cover and thus withdraw the retainer from the mouth. A lug on the rear feed lever serves as an anchorage for one end of the rear feed lever spring; the other end of the spring passes through a hole in the case and is secured by a pin. The spring tends to rotate the lever in the opposite direction to that in which the shaft rotates, but the rear feed lever stop, inside the rear cover, engages the rear arm of the lever to prevent it from rotating too far. The collar is secured to the shaft by a pin and bears against the rear cover.

(o) The mechanism is operated by the tension of the initially wound driving spring, but the tension is maintained by the recoil of the gun which actuates the charging cam assembly (fig. 43). It takes a recoil of approximately $1\frac{3}{16}$ inch to operate the feed properly, depending on the setting of the magazine slide and the temperature of the gun. The charging cam mechanism consists of a special gas cylinder guide A25940 which mounts a bracket with a lever having an inclined surface at the rear. A roller is pinned to the lever below the inclined surface. The feed mechanism and magazine slide remain stationary, and the charging cam lever recoils with the gun. During this motion, the charging cam roller rides up the inclined face on front of the magazine slide while the rack roller rides up the inclined surface on the charging cam lever. This combined movement actuates the tensioning ratchet to maintain the tension of the driving spring. Unwinding of the spring is prevented by the ratchet tensioning pawl in the front cover.

NOTE: The description above is applicable for either left- or right-hand feed mechanisms. Left-hand parts are of the same dimensions and shapes as right-hand parts, but their positions in the feed mechanism are reversed.

(2) **FUNCTIONING OF 20-MM FEED MECHANISM AN-M1** (figs. 48, 49, and 50).

(a) The belt is inserted into the belt guide with the bullets pointing toward the front. The links should be entering the belt guide, with

DESCRIPTION, FUNCTIONING, AND INSTALLATION



RA PD 68806

*Figure 48 — Separation of Links from Rounds in 20-MM
Feed Mechanism AN-M1 — Right Side View*

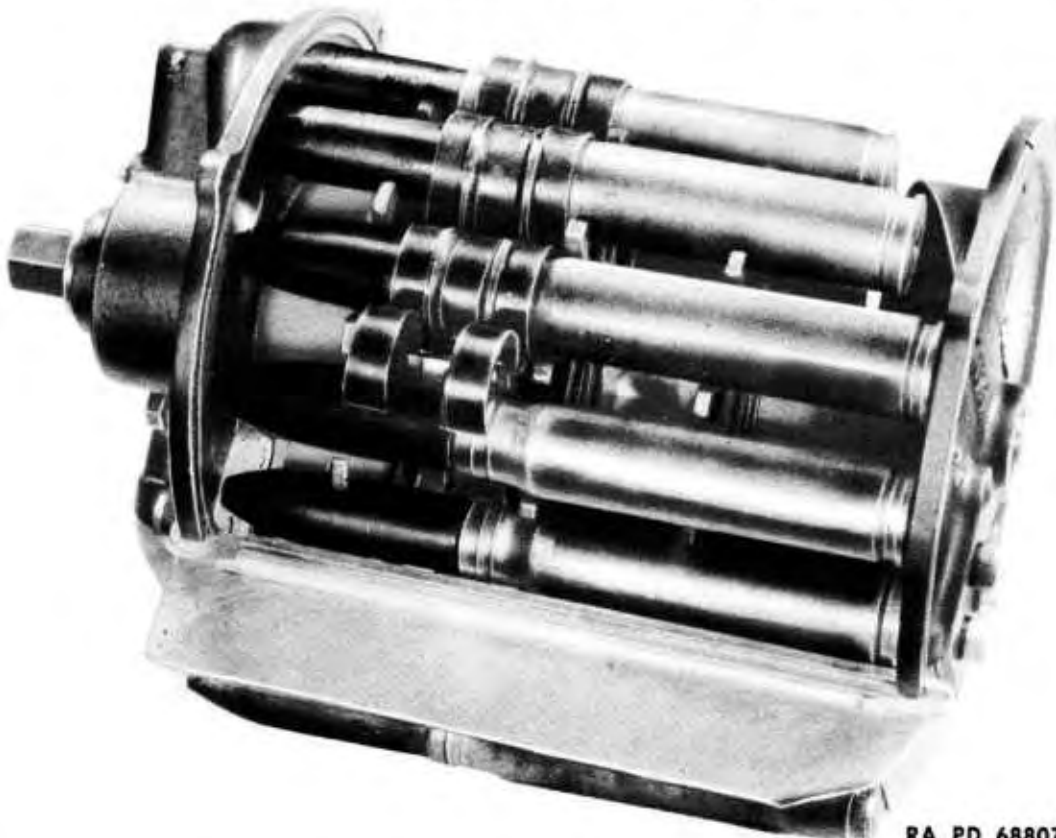

RA PD 68807

*Figure 49 — Separation of Links from Rounds in 20-MM
Feed Mechanism AN-M1 — Left Side View*

**20-MM AUTOMATIC GUN M1 AND
20-MM AIRCRAFT AUTOMATIC GUN AN-M2**

their double loops leading and the open sides of the loops facing towards the mouth. The belt is fed by hand into the mechanism and the rounds engage the feed sprockets. The tensioning ratchet is rotated by wrench to pull the belt into the mechanism. Rotation of the tensioning ratchet winds up the driving spring which then reacts in the spring case and rotates the shaft and feed sprockets, thus drawing the belt further into the mechanism.

(b) As the belt is carried round by the feed sprockets, the noses of the bullets are in contact with the bottom of the cam groove formed in the front cover, and the rounds are pushed towards the rear. The links are prevented from moving towards the rear by engagement with the teeth of the center feed sprocket, and when the rounds have been pushed back through a distance equal approximately to the width of a link, the links are freed from the rounds. As the rounds are carried past the link ejector, they cause the link ejector sprockets to rotate so that the teeth engage the middle portion of each link as it becomes free and push it outwards. The double loops of the link, which are leading, engage the ramp inside the link chute cover with their closed sides and the ramp causes the link to tilt on the teeth of the ejector sprockets so that the single loop is moved clear of the round. Continued movement of the main sprockets carries the round further around, and the link ejector sprockets rotate so that the single loop of the link engages the ramp inside the link chute cover and the double loops are cleared from the round. The pivotal movement of the link is limited by the engagement of first the double loops and then the single loop with the ramp, so that the single loop cannot re-engage the round and the link falls away through the link chute. After the ejection of the link, the spring-actuated plunger in the link ejector bracket acts on the flats of the link ejector shaft and holds the link ejector sprockets in the correct position to be engaged by the next round in the mechanism.

(c) Each round, after passing the link ejector, comes into contact with the feed levers and the curved surface of the link ejector bracket. The feed levers are pushed aside against the action of the springs and this movement withdraws the last round retainer so that it does not obstruct the passage of the rounds into the mouth. After each round passes the feed levers, the latter are partly returned by their springs to hold the rounds firmly in the mouth. After the first round has been seated in the bottom of the mouth, further rotation of the ratchet winds up the driving spring until it reaches maximum tension.

(d) When the gun is fired, the breechblock travels forward, hits the base of the round, and drives the round forward out of the mouth of the feed mechanism into the chamber of the gun. As each round

DESCRIPTION, FUNCTIONING, AND INSTALLATION

(6) Type F is used by the British. It consists of the basic M1 Gun with the M7 adapter (with thread protector), and M1 sear mechanism (fig. 24).

(7) Type G is used by the British. It consists of the basic AN-M2 Gun with M7 adapter (with thread protector), and M1 sear mechanism (fig. 24).

10. ADAPTERS.

a. Functioning of 20-mm Adapter AN-M1 (figs. 25 and 26).

(1) The adapter is a self-contained tubular unit which slips over the tube of the gun. The purpose of the adapter is to reduce the effective recoil and counterrecoil forces of the gun on its supporting structure and accurately control the amount of recoil travel within definite limits (0.875 inch to 1.17 inches). It provides a front mounting arrangement for the gun and also permits the gun to recoil the required distance to operate the AN-M1 feed mechanism or any other feed mechanism that derives its operating power from the recoil movement of the gun.

(2) The adapter consists essentially of a ring spring in series with a coil spring (fig. 26). The ring spring is assembled under compression. The ring spring is fitted around the front mandrel and the recoil spring is fitted around the rear mandrel, both springs and their mandrels being assembled in the outer shell.

(3) The ring spring consists of nine conically shaped inner rings which are positioned between and bear upon eight conically shaped outer rings.

(4) The adapter is held firmly in place on the gun tube by means of a tube sleeve and tube sleeve nut. The nut is prevented from unscrewing by means of a tube sleeve nut detent. The outer shell is fastened securely to the supporting structure. The front mandrel abuts the shoulder on the gun tube and moves with the tube. The bearing surfaces between the recoiling and non-recoiling components of the adapter are between the front and rear mandrels and between the front inner collar and front mounting collar.

(5) When the gun is fired, the tube sleeve moves to the rear with the gun barrel. Inasmuch as the initial compression of ring spring is greater than the final force of the coil spring, the ring spring holds the rear follower plate against the shoulder of the moving sleeve. It can thus be seen that during this phase of the recoil stroke, the coil spring alone is offering resistance to the rearward motion of the gun. This action continues until a distance of $\frac{7}{8}$ inch has been traversed, at which time the front mandrel abuts the rear mandrel. At this instant compression of the coil spring stops, the remainder of the impact being absorbed by the ring spring.

20-MM AUTOMATIC GUN M1 AND
20-MM AIRCRAFT AUTOMATIC GUN AN-M2

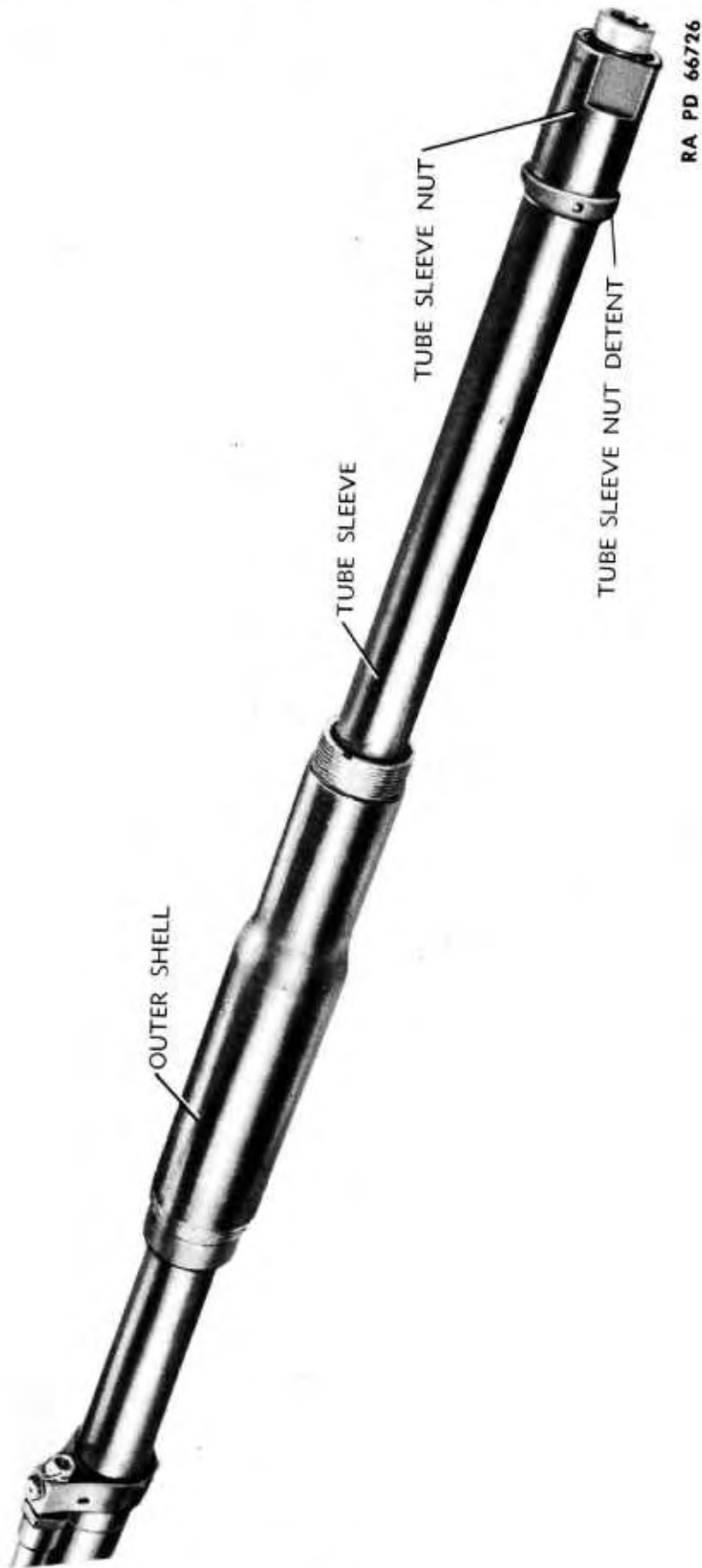
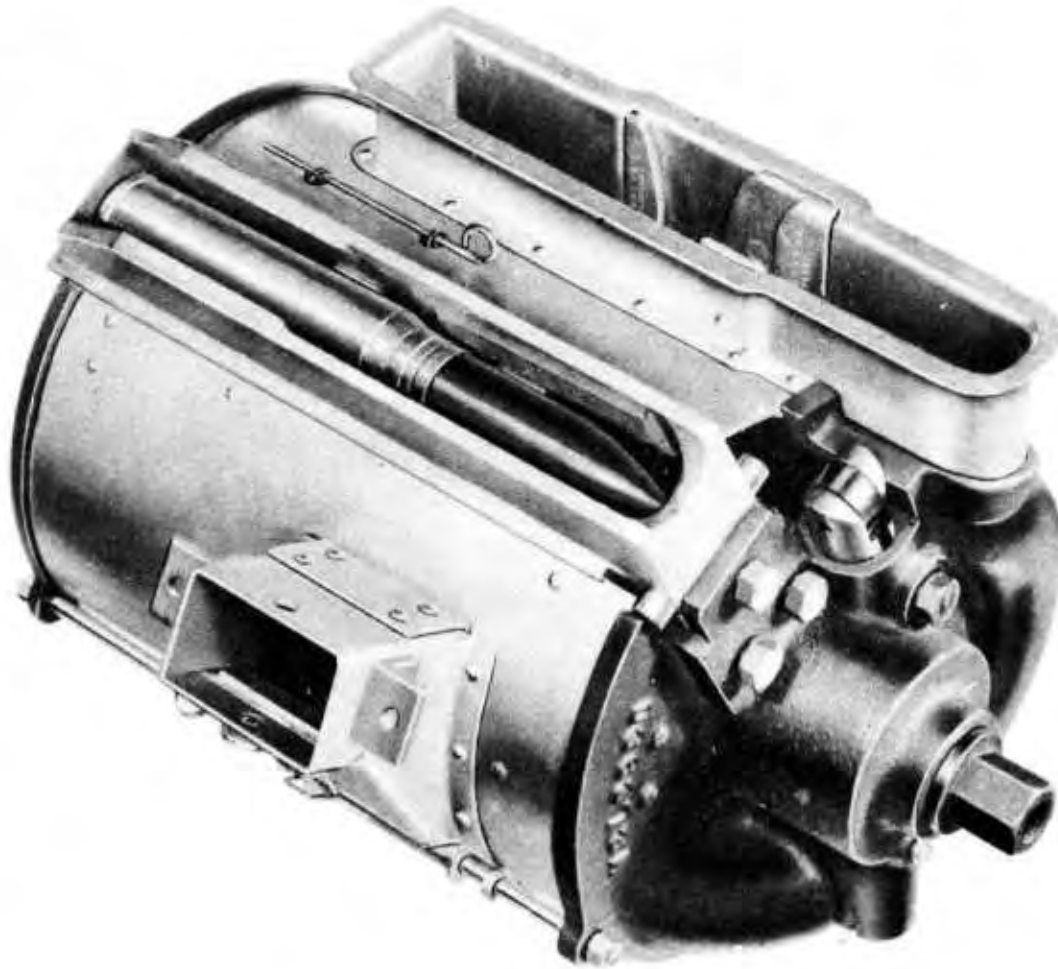

Figure 25 — AN-M1 Adapter on Gun

DESCRIPTION, FUNCTIONING, AND INSTALLATION



RA PD 68805

**Figure 50 — 20-MM Feed Mechanism AN-M1 —
Last Round Held by Retainer**

leaves the mouth, the driving spring acts in the driving spring case to rotate the shaft and the feed sprockets, thereby feeding another round into the mouth.

(e) After the last round but one has been pushed out of the mouth by the breechblock, the last round begins to move downward. This permits the two feed levers to move to their maximum extent through the action of the springs so that the rear feed lever abuts its stop on the rear cover while the last round retainer projects into the mouth and prevents the last round from reaching the loading position (fig. 50). If a fresh belt is fed into the mechanism while the last round of the previous belt is still in the mouth, the first round of the fresh belt becomes the second round in the mouth and the last round of the previous belt can be fired in the normal manner.

(3) **HAND-LOADING OF BELTS FOR RIGHT-HAND FEED** (fig. 51).

(a) Inspect all links for rust, dirt, or deformed links.

20-MM AUTOMATIC GUN M1 AND
20-MM AIRCRAFT AUTOMATIC GUN AN-M2



RA PD 66742

Figure 51 — 20-MM Round in Links for R.H. Feed

(b) Dip all links in OIL, lubricating, preservative, special, and drain off excess oil just before using.

(c) Dip a clean lintless cloth in OIL, lubricating, preservative, special, wring it out, and oil the cartridge cases with it, being careful not to oil the primers of the joint where the case is cramped to the projectile.

(d) Lay the links along the bench, with their open sides up, double loops to the right, and single loops positioned between the double loops.

(e) Insert a round into each loop, including the leading double loop, and push it forward.

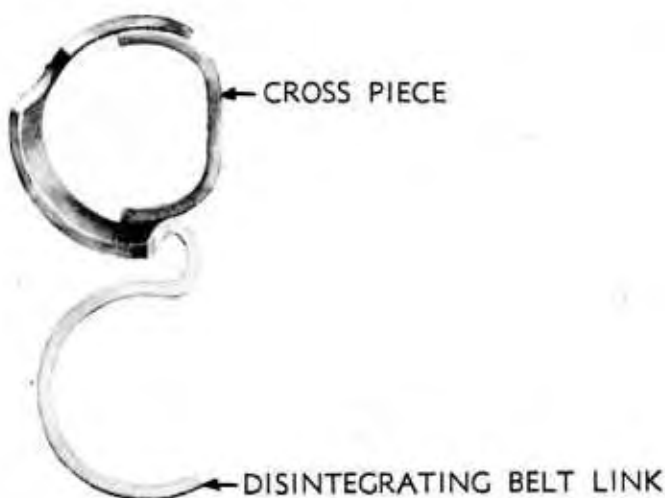

RA PD 10931

Figure 52 — End Link

DESCRIPTION, FUNCTIONING, AND INSTALLATION



RA PD 66743

Figure 53 – 20-MM Rounds in Links for L.H. Feed

(f) The last link at the left end of the belt of ammunition to be fired by means of the feed mechanism must be of the closed single loop type (fig. 52) to prevent the last link from jamming or catching within the feed mechanism.

(g) Check the position of the cartridges relative to the links. The distance from the base of the cartridge case to the front edge of the double loop should be 3.80 inches.

(h) Test the belt for flexibility by lifting the left end loop and drawing along the top of the belt to the right. Any faulty link will cause the belt to “kink” instead of folding over smoothly. Any link which does not hinge freely must be replaced by another and the test repeated.

(i) Repeat the above test, starting with the right end loop and drawing it to the left. If a stiff link is found, it must be replaced by another and both right end and left end tests repeated.

(j) Test the belt for oversize links by suspending it from one end and twisting the lowest link until resistance is felt. If the belt breaks, the faulty link must be replaced by another and all tests repeated.

(4) **HAND-LOADING OF BELTS FOR LEFT-HAND FEED.** The procedure is the same as in subparagraph a (3) above, except that the position of the links is reversed (fig. 53). The double loops are to the left, and the special end link is at the right end.

(5) **JOINING A NEW BELT TO A PARTLY EXPENDED BELT.**

(a) Remove the special link from the end of the partly expended belt.

**20-MM AUTOMATIC GUN M1 AND
20-MM AIRCRAFT AUTOMATIC GUN AN-M2**

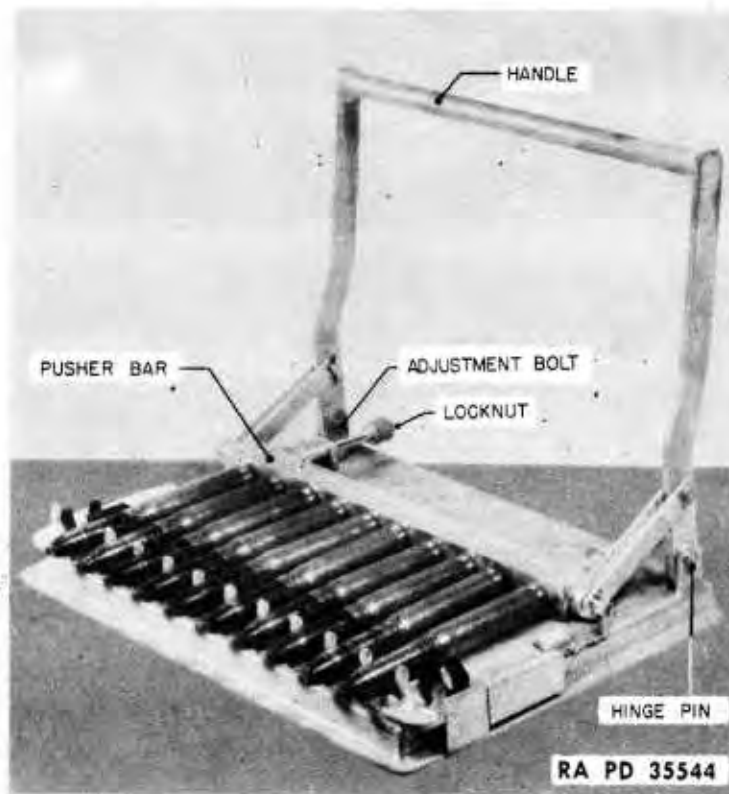

Figure 54 — Position of Links and Cartridges in Machine

- (b) Join the two belts by means of an ordinary link.
- (c) Check the position of the round which has been inserted to join the belt.
- (d) Be sure that the last round in the ammunition container has the special end link.
- (6) **LOADING OF BELTS WITH 20-MM AMMUNITION LINKING MACHINE M4 FOR RIGHT-HAND FEED.**
- (a) Inspect and lubricate links and lubricate rounds as described in subparagraph a (3) (a), (b), and (c) above.
- (b) Place 11 links in a continuous row along the link guide, with their open sides up, double loops to the right and single loops positioned between the double loops. The left end link must be of the closed, single loop type (fig. 52).
- (c) Place 10 cartridges in the 10 central grooves of the cartridge guide, with their noses resting in the links (fig. 54).
- (d) Push forward on the handle with steady pressure until the stroke is stopped by the lock nuts on the adjustment bolts (fig. 55).
- (e) Pull back the handle. Lift out the 10 cartridges which are now

DESCRIPTION, FUNCTIONING, AND INSTALLATION

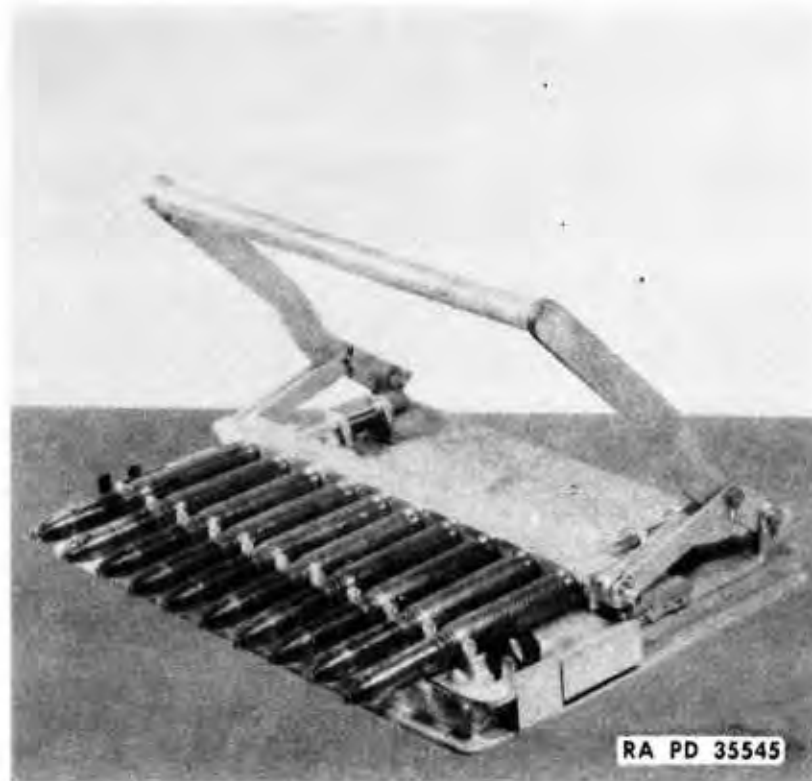

Figure 55 – Cartridges and Links Assembled by Machine

linked together and place the right end cartridge in the left end groove. Place additional links and cartridges in the guides and repeat the operations until the belt is of the desired length (fig. 56).

(f) Test flexibility of belt as directed in subparagraph a (3) (h) above.

(7) **ADJUSTMENT.** The machine is provided with lock nuts and two adjustment bolts on the pusher bar to regulate the length of the stroke. These should be set so that when the pusher bar is in its forward position, the distance between the face of the bar and the link stop should be 3.80 inches.

(8) LOADING BELTS WITH AMMUNITION LINKING MACHINE FOR LEFT-HAND FEED.

(a) Place 11 links in a continuous row along the link guide, with their open sides up, double loops to the left and single loops positioned between the double loops. The right end link must be of the closed, single loop type (fig. 52).

(b) Place 10 cartridges in the 11 central grooves of the cartridge guide, with their noses resting in the links.

(c) Push forward on the handle with steady pressure until the stroke is stopped by the lock nuts on the adjustment bolts.

**20-MM AUTOMATIC GUN M1 AND
20-MM AIRCRAFT AUTOMATIC GUN AN-M2**

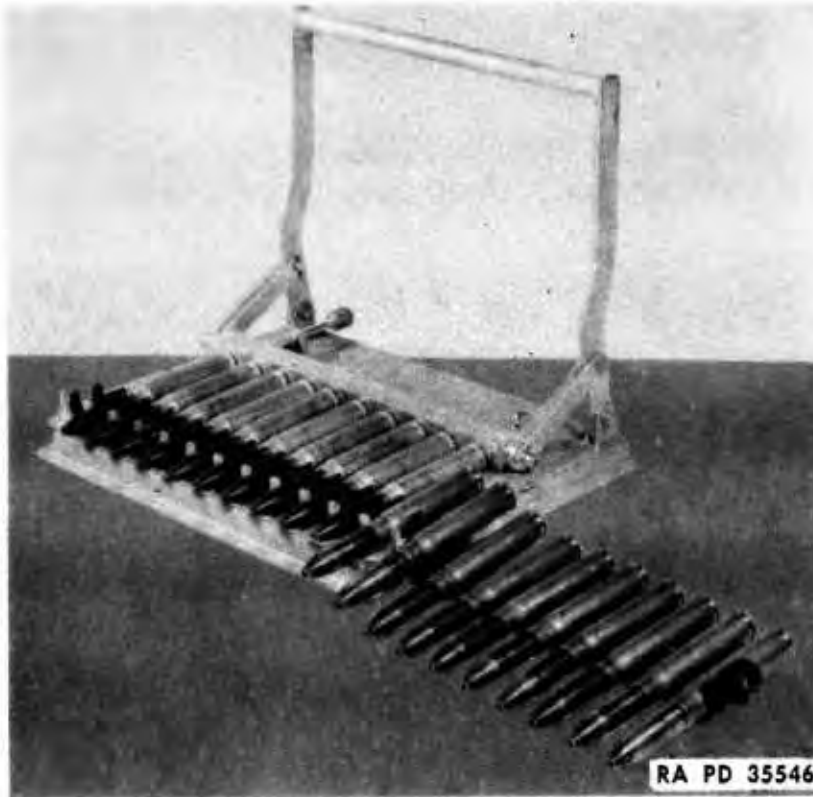

Figure 56 — Forming Continuous Linkage

(d) Pull back the handle. Lift out the 10 cartridges which are now linked together and place the left end cartridge in the right end groove. Place additional links and cartridges in the guides and repeat the operations until the belt is of the desired length.

(e) Test the flexibility of the belt as instructed in subparagraph a (3) (h) above.

(9) **UNLOADING.** Set the locknuts so as to increase the stroke about $\frac{1}{2}$ inch. Place the belt in the machine, in reversed position, and gently force the cartridges out of the links.

(10) **LOADING THE 20-MM FEED MECHANISM AN-M1.**

(a) If the feed mechanism is not assembled to the gun, insert a loaded belt of 18 rounds into the belt guide of the right-hand feed mechanism with the double loop of the link leading, cartridges pointing toward the front cover, and the open sides of the links toward the mouth. Position the sprocket by hand so that the first round can enter freely and then push the belt in as far as possible. Turn the tensioning ratchet with a wrench (fig. 57) until the driving spring is solid, strip the first round, and hook the single loop of the last link around the edge of the link chute (fig. 58). This provides for easy handling of the feed mechanism before being installed on an airplane. If the feed mechanism is assembled to the gun, close the breechblock, load the feed

DESCRIPTION, FUNCTIONING, AND INSTALLATION



RA PD 66744

Figure 57 — Loading R.H. Feed Mechanism

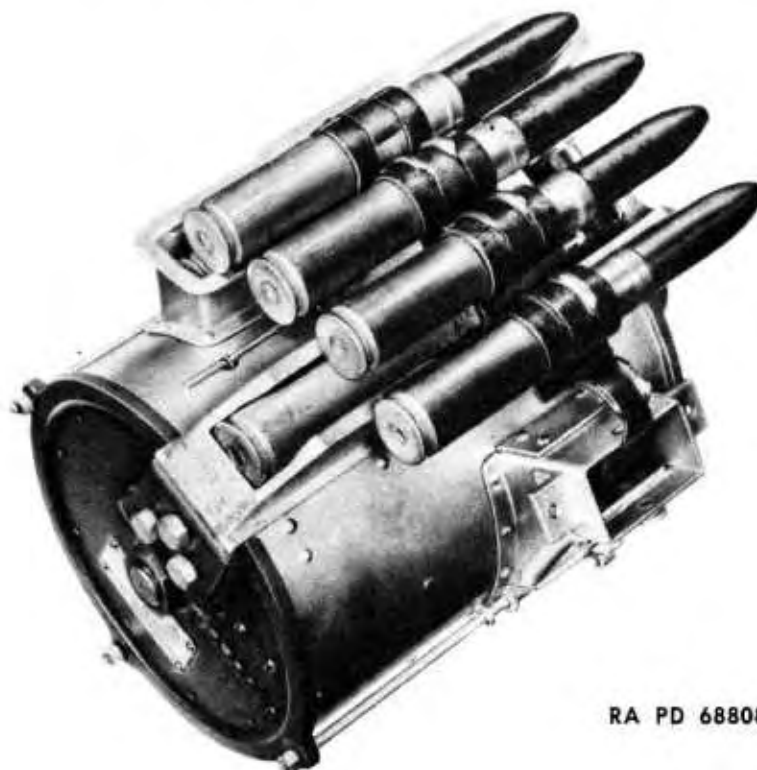

RA PD 68808

Figure 58 — Loading Feed Mechanism

20-MM AUTOMATIC GUN M1 AND
20-MM AIRCRAFT AUTOMATIC GUN AN-M2



RA PD 10804

Figure 60 — 60-round Magazine — Rear View

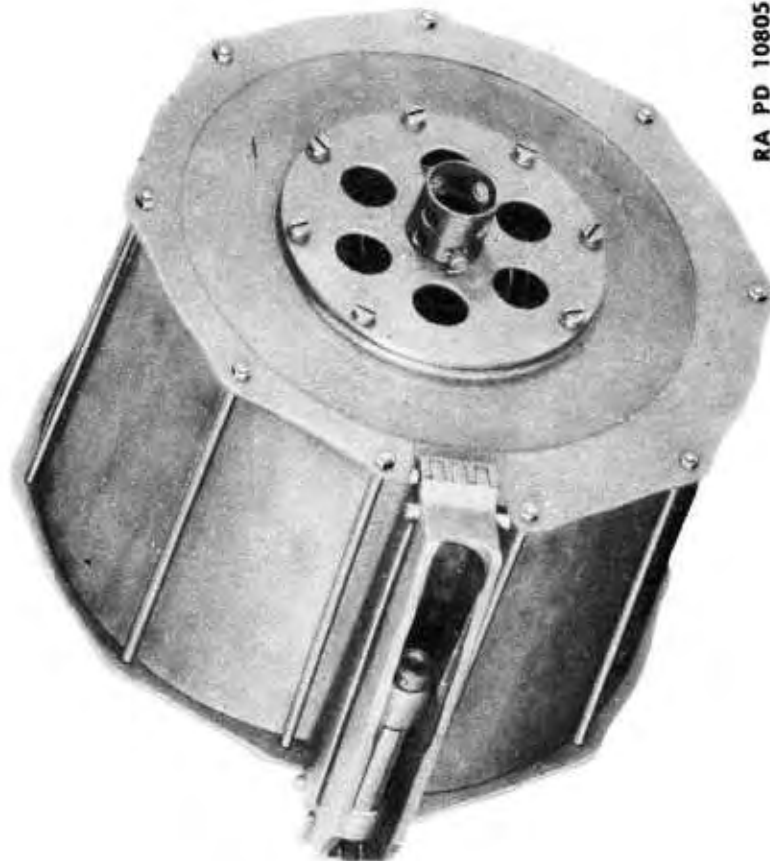

RA PD 10805

Figure 59 — 60-round Magazine — Front View

DESCRIPTION, FUNCTIONING, AND INSTALLATION

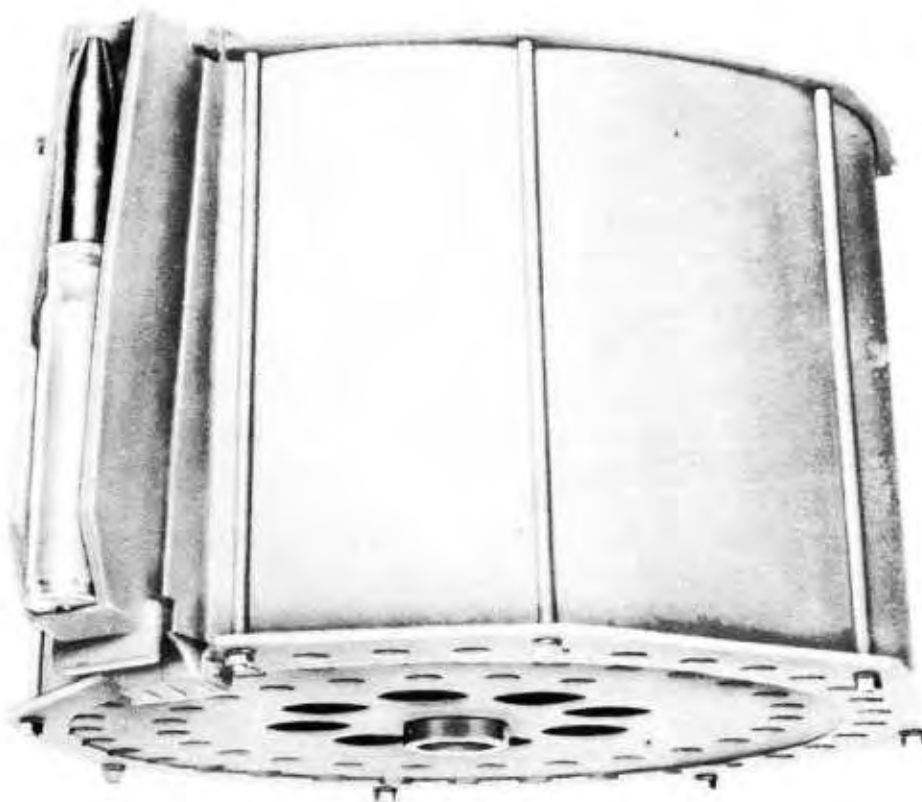

RA PD 10812

Figure 62 — Round in Loaded Position



RA PD 10811

Figure 61 — Loading 60-round Magazine

20-MM AUTOMATIC GUN M1 AND 20-MM AIRCRAFT AUTOMATIC GUN AN-M2

mechanism, and wind the driving spring until solid. Cock the gun.

CAUTION: Be extremely careful not to exert more torque than is necessary to wind the driving spring solid. Excessive torque applied against a tightly wound driving spring will result in breakage of the driving spring. If any difficulty is experienced in pulling the belt through the feed mechanism before the desired initial torque is obtained, the belt should be examined for defective links.

b. Description and Functioning of 20-mm 60-round Magazine M1 (figs. 59, 60, and 92).

(1) The 20-mm 60-round Magazine M1 consists essentially of an outer casing closed by front and rear plates and containing a tensioning spring in a spring casing in the front plate. A hole in the rear plate accommodates the feed arm axis tube. The inner end of the spring is attached to the tensioning tube. On the inside of the plates are spirals which act as guides for the ammunition.

(2) The magazine is operated by the spring tension. Initial tension is applied during assembly. Further tension is applied progressively during the loading operations. The tensioned spring acts through the tensioning tube, feed arm axis tube, and feed arm to maintain the platform or follower in contact with the last round. Thus a round is always in position in the magazine mouth. As soon as this round is loaded, the next round is brought into position by the spring.

c. Loading the 20-mm 60-round Magazine M1.

(1) If the magazine has been disassembled, apply initial tension as follows:

(a) Place the magazine in the magazine holder or in any other suitable retaining device.

(b) Remove the cotter pin and tensioning tube pin, if necessary.

(c) Rotate the magazine until the follower is in the mouth.

(d) Insert the tensioning tube bar through the end of the tensioning tube and turn it counterclockwise three-quarters of a turn.

(e) Insert the tensioning tube pin and secure it with a cotter pin.

(f) Insert the bar through the hole in the tensioning tube and turn it slightly counterclockwise to lower the platform, so as to allow a round to be inserted.

(g) Insert a round, base first, into the mouth of the magazine and push it against the rear plate (fig. 61). Ease the bar, and see that the round is flush against the rear plate (fig. 62).

(h) Turn the bar slightly counterclockwise to lower this first round, and then insert a second round in the same manner.

(i) Repeat the operation until the magazine contains not over 55 rounds, taking care that the first round inserted contacts the platform or follower. No further tension must be applied. It is advisable not to load the magazine with more than 55 rounds.

Section III

OPERATION

	Paragraph
Installation of magazine slide.....	14
Installation of 20-mm feed mechanism AN-M1 on the gun.....	15
Firing the gun.....	16
Unloading the gun (20-mm feed mechanism AN-M1).....	17
Installation of 20-mm 60-round magazine M1 on the gun.....	18
Unloading the gun (20-mm 60-round magazine M1).....	19

14. INSTALLATION OF MAGAZINE SLIDE.

a. Secure the magazine slide to the magazine slide anchoring mechanism.

b. If the 20-mm feed mechanism AN-M1 is to be used, adjust the magazine slide anchoring mechanism so that the engraved lines on the magazine slide are $\frac{1}{16}$ inch to the rear of the engraved lines on the receiver. This adjustment must be made when the gun is cold. With this adjustment, the maximum advisable length of burst is 75 rounds.

c. If the 20-mm 60-round magazine M1 is to be used, adjust the magazine slide anchoring mechanism so that the engraved lines on the magazine slide match the engraved lines on the receiver.

15. INSTALLATION OF 20-MM FEED MECHANISM AN-M1 ON THE GUN.

a. Charge the gun. Hold the feed mechanism, loaded with 17 rounds (par. 13 a (10)), above the magazine slide with the tensioning ratchet pointing toward the muzzle. Carefully lower the mechanism so that the mouth enters the opening of the magazine slide and the latch plate at rear of the mouth rests on the magazine latch. Push the mechanism forward until the transversely projecting pins at the front of the mouth engage the hook-shaped projections at the front of the magazine slide (fig. 63). Lift the magazine slide lever and engage the magazine latch with the latch plate at the rear of the mouth. If the mechanism is properly secured, as described in paragraph 14 a, there will be approximately a 0.05-inch clearance between the operating lever and the rack roller (fig. 64).

b. Join the belt in the feed mechanism to the belt in the ammunition container by inserting a round and joining the link of the last round in the feed mechanism to the first link of the belt in the ammunition container. Make certain that the belt in the feed mechanism and the belt in the ammunition container are linked for feeding in the

20-MM AUTOMATIC GUN M1 AND
20-MM AIRCRAFT AUTOMATIC GUN AN-M2

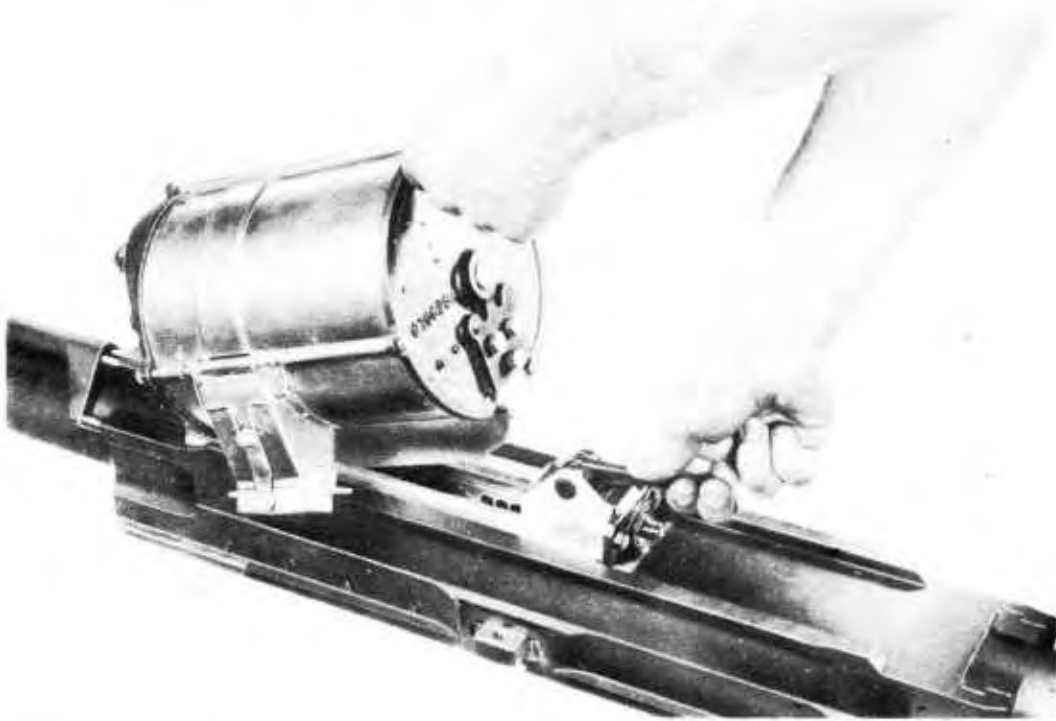

RA PD 68809

Figure 63 — Installation of 20-MM Feed Mechanism AN-M1 on the Gun

same direction, that the round used to join the belts is properly positioned, and that the special end link is on the last round in the ammunition container.

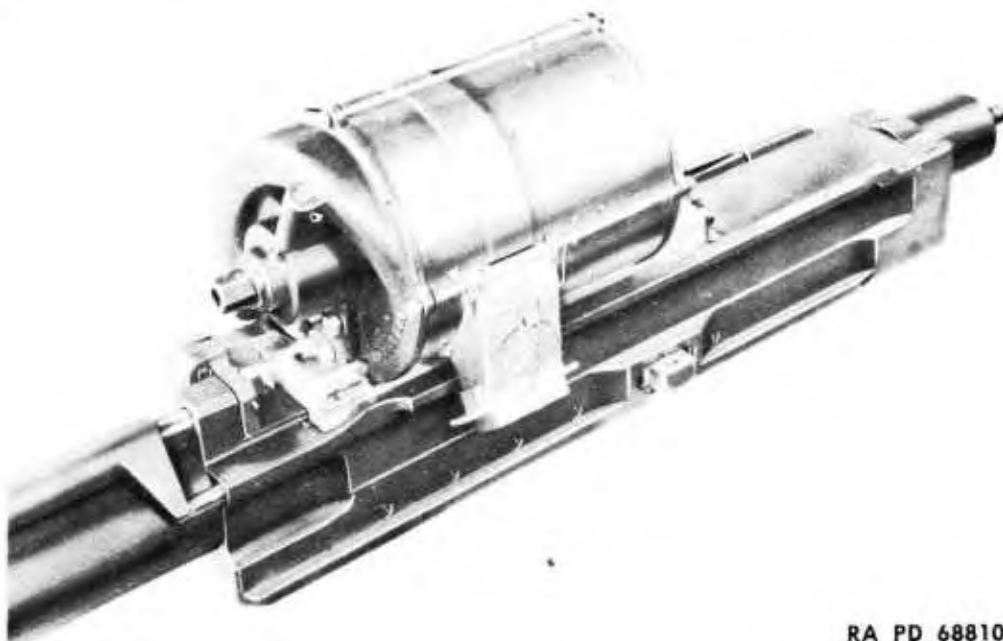

RA PD 68810

Figure 64 — Feed Mechanism in Position on Gun

OPERATION



RA PD 68811

Figure 65 – Removal of Last Round

- c. Attach the link and feed chutes to the feed mechanism.
- d. Test the rack operating assembly for vertical movement before the gun is fired. If rack cannot be raised, turn tensioning ratchet until a single click is heard.
- e. Recoil of the gun must be checked with a fully wound mechanism containing at least five rounds of ammunition. If the recoil is less than $\frac{7}{8}$ of an inch, washers must be placed in front of the sleeve to lengthen the height of the recoil spring to obtain the $\frac{7}{8}$ -inch recoil. If the recoil is more than $\frac{7}{8}$ inch, washers must be placed in front of the spring to shorten the spring to obtain the $\frac{7}{8}$ -inch recoil.

NOTE: When the 20-mm feed mechanism AN-M1 is used with adapter AN-M1 or M6, no special adjustments are made to adapters. When the M7 adapter is used, the muzzle brake must be replaced with the thread protector.

16. FIRING THE GUN.

- a. **Firing.**
 - (1) Charge the gun.
 - (2) Actuate the firing mechanism to fire the gun.
- b. **To Cease Firing.** Discontinue actuating the firing mechanism.
- c. The same method of firing is employed, regardless of the type of feed mechanism used.

20-MM AUTOMATIC GUN M1 AND
20-MM AIRCRAFT AUTOMATIC GUN AN-M2



RA PD 10809A

Figure 66 — Installation of 20-MM 60-round Magazine M1 on Gun

17. UNLOADING THE GUN (20-MM FEED MECHANISM AN-M1).

- a. Point the gun in a safe direction.
- b. Disconnect the link and feed chutes from the feed mechanism if necessary.
- c. Break the belt near the belt guide by withdrawing a round from the links if there.
- d. Lift the magazine slide lever to disengage the magazine latch from the feed mechanism.
- e. Pull the feed mechanism upward and rearward and remove it from the gun.
- f. If the breechblock is retracted, be sure the chamber is clear and then actuate the firing mechanism. If the breechblock is in the forward position, charge the gun, be sure the chamber is clear, and then actuate the firing mechanism.
- g. Remove the rounds from the mouth of the feed mechanism by pushing them forward with a blunt wooden instrument, such as a hammer handle. Do not drop the cartridges as they are removed. Keep fingers clear of the working parts of the mechanism.
- h. To remove the last round from the mouth, open the link chute cover and, with a screwdriver, push the lower end of the front feed lever so that it rotates and the last round retainer is displaced (fig. 65) allowing the last round to drop down into the mouth.
- i. Push the last round forward in the mouth and remove it.

OPERATION



RA PD 10808A

Figure 67 – Loaded Magazine in Position on Gun

18. INSTALLATION OF 20-MM 60-ROUND MAGAZINE M1 ON THE GUN.

a. The magazine should be used with M7 adapter and muzzle brake only.

b. Place a fully loaded magazine on top of the magazine slide and engage the two pins at the front of the mouth with the hook-shaped projections at the front of the slide (fig. 66). Lift the magazine slide lever to engage the magazine latch with the rear of the magazine (fig. 67).

19. UNLOADING THE GUN (20-MM 60-ROUND MAGAZINE M1).

a. Point the gun in a safe direction.

b. Lift the magazine slide lever to disengage the magazine latch from the magazine; then pull the magazine upward and rearward and remove it from the gun.

c. If the breechblock is retracted, be sure the chamber is clear and then actuate the firing mechanism. If the breechblock is in the forward position, charge the gun, be sure the chamber is clear, and then actuate the firing mechanism.

20-MM AUTOMATIC GUN M1 AND
20-MM AIRCRAFT AUTOMATIC GUN AN-M2

Section IV

DISASSEMBLY AND ASSEMBLY

	Paragraph
General	20
Special tools	21
Disassembly of the basic gun	22
Assembly of the basic gun	23
Disassembly of 20-mm feed mechanism AN-M1	24
Assembly of 20-mm feed mechanism AN-M1	25
Disassembly of 20-mm 60-round magazine M1	26
Assembly of 20-mm 60-round magazine M1	27

20. GENERAL.

a. Disassembly and assembly as described in the following paragraphs are intended for instruction, detailed cleaning and lubrication, detailed inspection, and replacement of parts. The gun should always be kept on wooden supports during disassembly and assembly in order to prevent it from falling and being damaged. In order to avoid damage which may result in malfunctions, parts should not be forced during disassembly and assembly.

21. SPECIAL TOOLS.

a. Special tools to be used in disassembly and assembly are listed in section IX and illustrated in figure 99.

22. DISASSEMBLY OF THE BASIC GUN.

a. Driving Spring Guide Group.

(1) Make certain the breechblock is in its most forward position before proceeding any further.

(2) With a blunt chisel, straighten the rim of the retainer washer so that it does not engage the flat on the driving spring guide head (fig. 68).

(3) Insert the driving spring assembling tool through the driving spring guide head. Push the tool forward until it engages the driving spring guide plunger (fig. 69).

(4) Unscrew the driving spring guide assembly using the special rear buffer wrench (fig. 70). Remove the assembly together with the driving spring assembling tool and plunger.

DISASSEMBLY AND ASSEMBLY



RA PD 10932A

Figure 68 — Straightening the Retainer

(5) Withdraw the driving spring assembling tool. Remove the driving spring guide plunger and the driving spring.

(6) The driving spring guide and head are attached by a staked screw and a sweated joint, and should not be disassembled.

b. Rear Buffer Group.

(1) Retract the rear buffer lock plunger and remove the rear buffer group by sliding it out of the dovetail grooves in the receiver.

(2) Drift out the rear buffer lock plunger pin. Remove the plunger, spring, and collar.

(3) Secure the rear buffer assembly in a vise with soft jaws. Unstake the rear buffer threaded sleeve and unscrew the sleeve with the special rear buffer wrench (fig. 71). Remove the rear buffer washer and spring (fig. 72).



RA PD 10938A

Figure 69 — Inserting the Driving Spring Assembling Tool

20-MM AUTOMATIC GUN M1 AND
20-MM AIRCRAFT AUTOMATIC GUN AN-M2

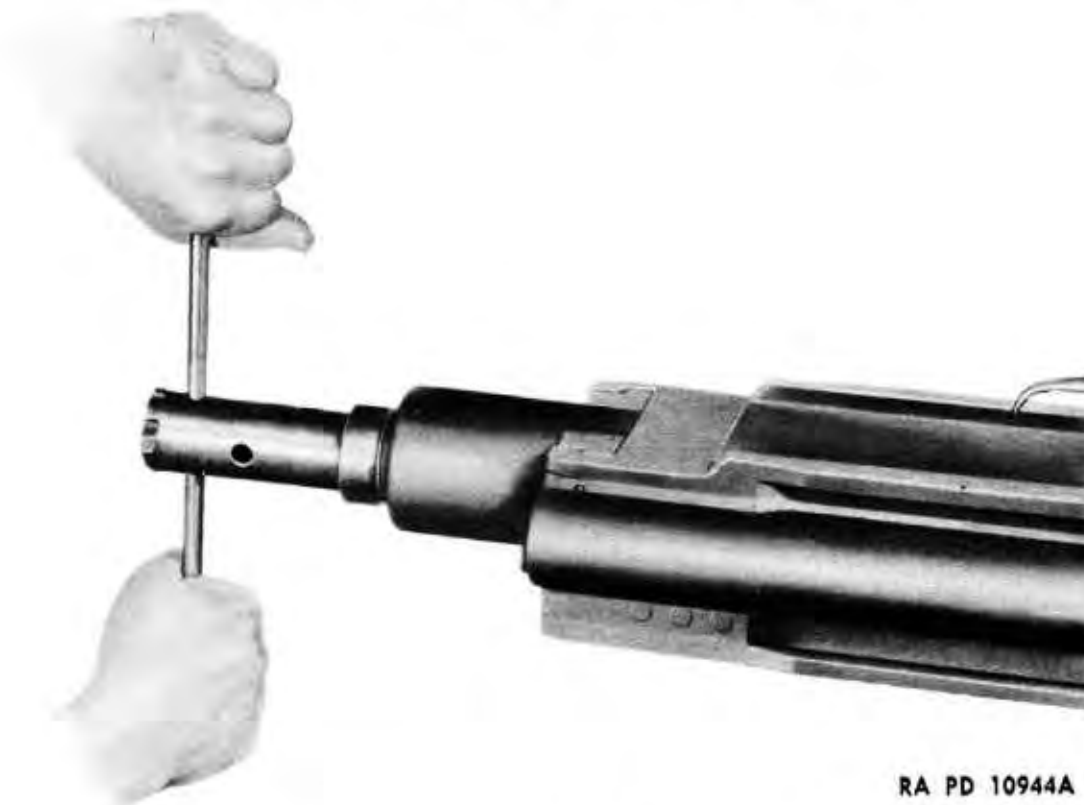

Figure 70 – Unscrewing the Driving Spring Guide Assembly

(4) The completely disassembled rear buffer group is shown in figure 72.

c. Breechblock Group.

(1) Engage the projection on the arm of the breechblock unlocking tool with the front face of the right breechblock slide (fig. 73).

(2) Place the other arm of the tool along the top of the breechblock with its end against the receiver (fig. 74).

(3) Press the lever of the tool forward to unlock the breechblock (fig. 75).

(4) Move the breechblock assembly to the rear of the receiver. As soon as it starts to come out, grasp the breechblock lock and hold it in the unlocked position (fig. 76). Failure to do this may cause the breechblock to get jammed in the rear portion of the receiver as it is being pulled out. Do not drop the breechblock lock.

NOTE: If the special tool is not available, use the hand charger to retract the breechblock. If hydraulic charger or manual charger is installed the breechblock may be unlocked by prying the push rods back with a screwdriver.

DISASSEMBLY AND ASSEMBLY



RA PD 10945

Figure 71 – Unscrewing the Rear Buffer Sleeve

(5) Remove the breechblock lock. Remove the left and right inertia blocks (fig. 77).

(6) Withdraw the left breechblock slide and then the right breechblock slide with the slide key assembled, being careful not to let the breechblock slide spring and guides fly out (fig. 77). Do not remove the breechblock slide key except for replacement.

(7) Press the extractor against the extractor spring and drift out the extractor pin. Withdraw the extractor and extractor spring (fig. 77). Lift the front end of the bolt assembly and allow the firing pin to slide out through the rear. Do not drop the firing pin.

d. Magazine Slide Group.

(1) Remove the cotter pin, unscrew the ejector stud nut, and remove the washers. Withdraw the ejector with the springs (fig. 78).

(2) Remove the locking wire, unscrew the magazine slide back plate screws, and remove the back plate with the magazine latch springs. (The magazine slide back plate should never be removed except when it is being replaced.) Remove the magazine slide lever pin and bushing, slide lever, and latch (fig. 78).

(3) Remove the magazine slide by sliding it to the rear.

20-MM AUTOMATIC GUN M1 AND
20-MM AIRCRAFT AUTOMATIC GUN AN-M2

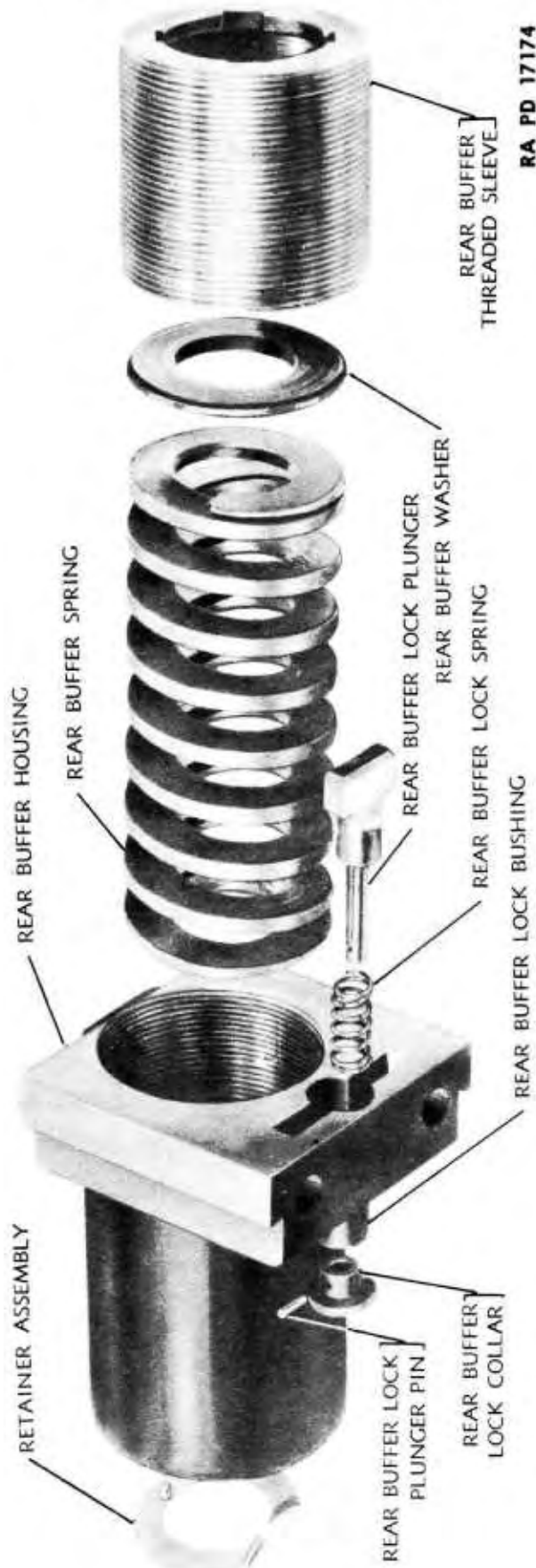
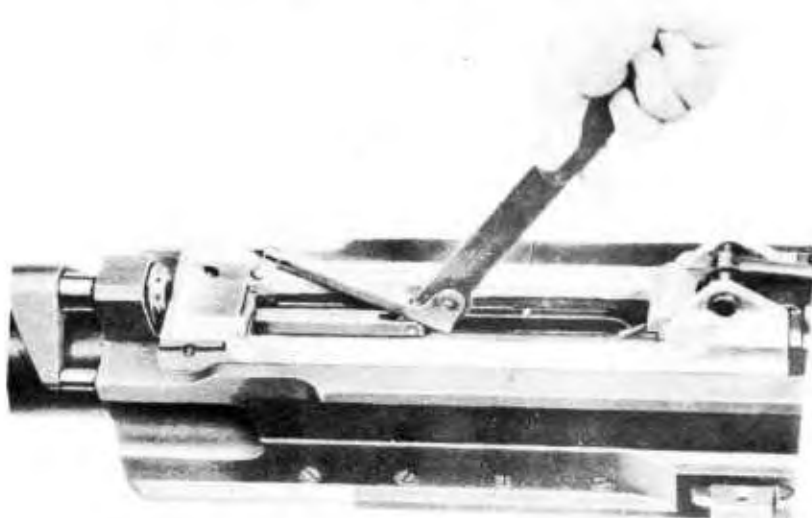

Figure 72 — Rear Buffer Group — Parts

DISASSEMBLY AND ASSEMBLY



RA PD 68837

Figure 73 – Placing the Breechblock Unlocking Tool in Position

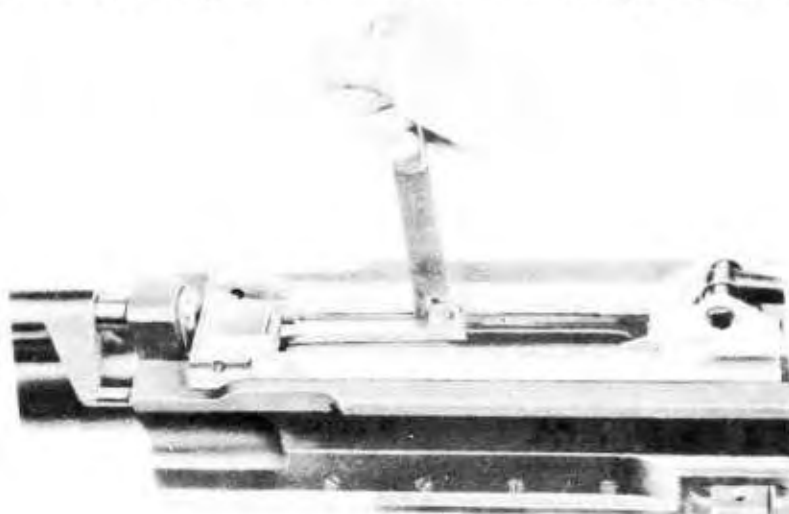

RA PD 68838

Figure 74 – Breechblock Unlocking Tool in Position

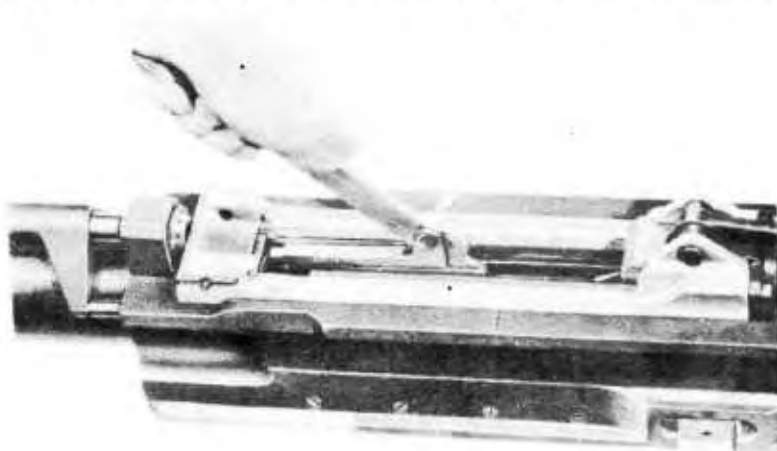

RA PD 68839

Figure 75 – Unlocking the Breechblock

**20-MM AUTOMATIC GUN M1 AND
20-MM AIRCRAFT AUTOMATIC GUN AN-M2**



RA PD 10818A

Figure 76 – Removing (or Replacing) the Breechblock

e. Gas Cylinder and Sleeve Group (fig. 79).

- (1) Remove cotter pin and lock washer from gas cylinder guide and unscrew the gas cylinder guide.
- (2) Remove the gas cylinder sleeve spring.
- (3) Remove locking wire from the gas cylinder bracket plug and then the gas cylinder lock washer. Unscrew gas cylinder bracket plug and remove gas cylinder lock plate. Unscrew gas cylinder vent plug.
- (4) Remove the gas cylinder and the sleeve from the gas cylinder bracket by sliding the assembly toward the rear of the gun.
- (5) Remove the gas cylinder from the sleeve.
- (6) Remove the gas cylinder sleeve push rods.

f. Receiver Slides. Turn the gun upside down. Remove the receiver slides from their slots in the receiver body by removing the cotter pins, nuts, and lock washers from the eight slotted head bolts that hold the two slides in position.

g. Sear Block Group.

- (1) Insert the sear buffer spring retaining tool into the hole in the sear block. Push the tool through the sear block so that it fully engages the circumferential grooves on the sear buffer spring plungers.
- (2) Carefully lift the sear block and sear out of the receiver with the retaining tool in place (fig. 80). Remove the steel and fiber sear buffer blocks from the receiver.
- (3) Withdraw the sear pin to detach the sear from the sear block.
- (4) Place the sear block in the sear block assembling tool so that the radial bearing surface of the sear block contracts the jaw of the tool while the plungers which protrude from the sear block engage the hook-

DISASSEMBLY AND ASSEMBLY

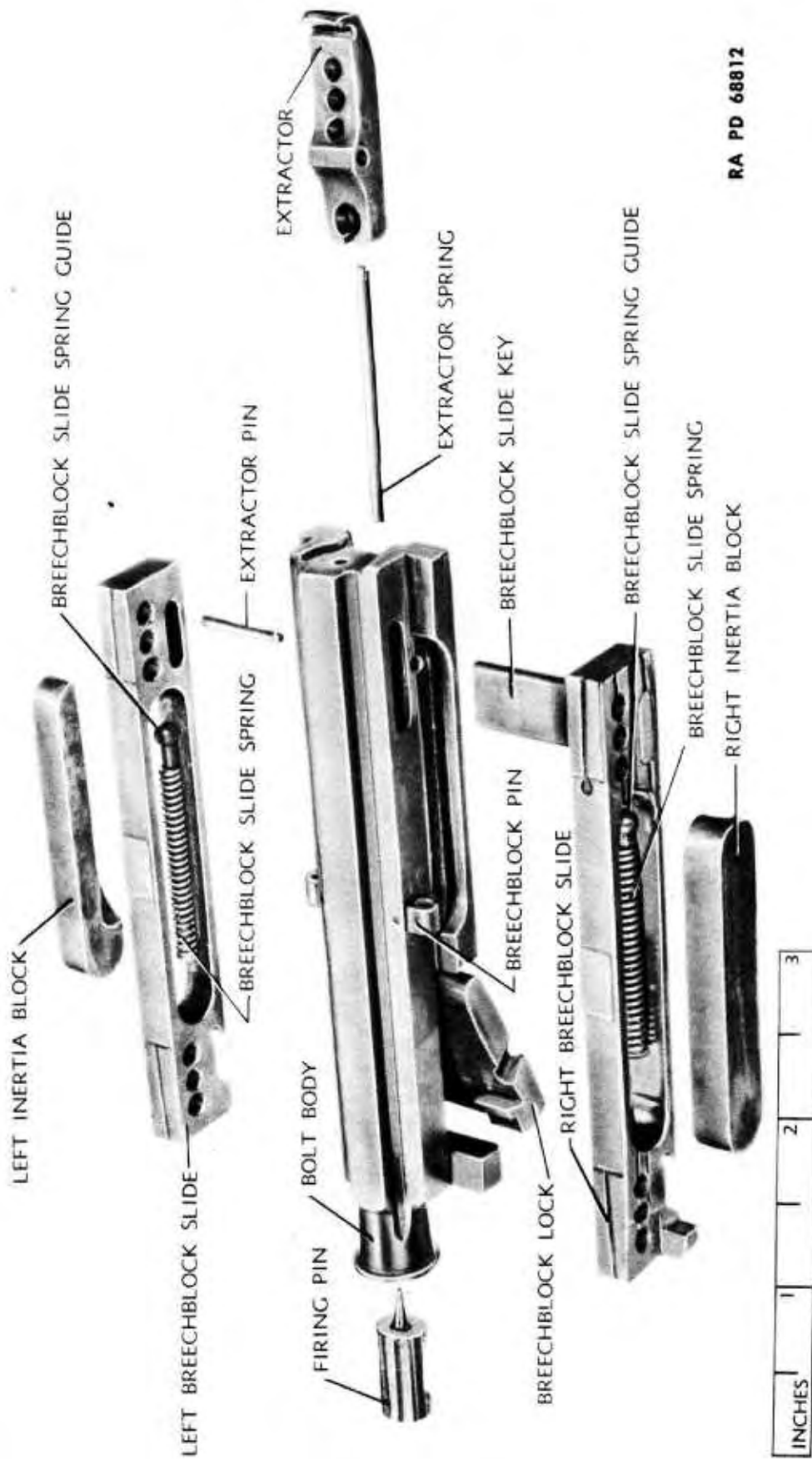
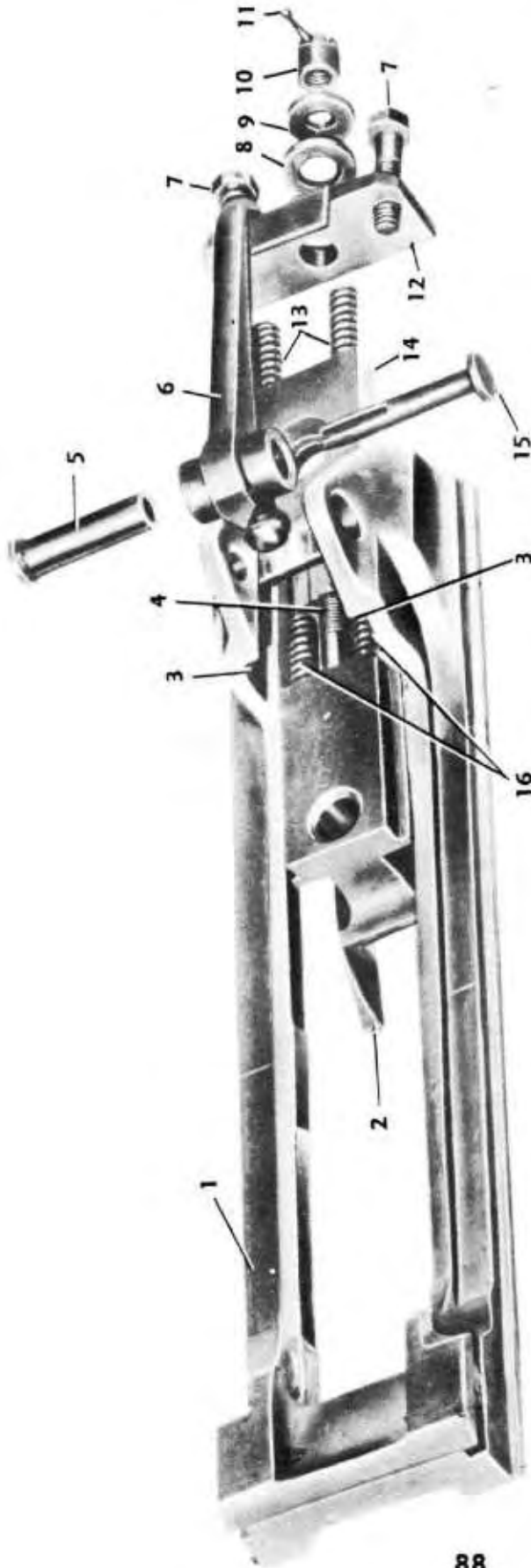

Figure 77 — Breechblock Group — Parts

20-MM AUTOMATIC GUN M1 AND
20-MM AIRCRAFT AUTOMATIC GUN AN-M2



- | | | | |
|-----|----------------------------------|------|---------------------------|
| 1 — | MAGAZINE SLIDE | 9 — | EJECTOR STUD NUT WASHER |
| 2 — | EJECTOR | 10 — | EJECTOR STUD NUT |
| 3 — | MAGAZINE LATCH GROOVES | 11 — | COTTER PIN |
| 4 — | EJECTOR STUD | 12 — | MAGAZINE SLIDE BACK PLATE |
| 5 — | MAGAZINE SLIDE LEVER PIN BUSHING | 13 — | MAGAZINE LATCH SPRING |
| 6 — | MAGAZINE SLIDE LEVER | 14 — | MAGAZINE LATCH |
| 7 — | MAGAZINE SLIDE BACK PLATE SCREW | 15 — | MAGAZINE SLIDE LEVER PIN |
| 8 — | EJECTOR STUD WASHER | 16 — | EJECTOR SPRING |

RA PD 68813

Figure 78 — Magazine Slide Group

DISASSEMBLY AND ASSEMBLY

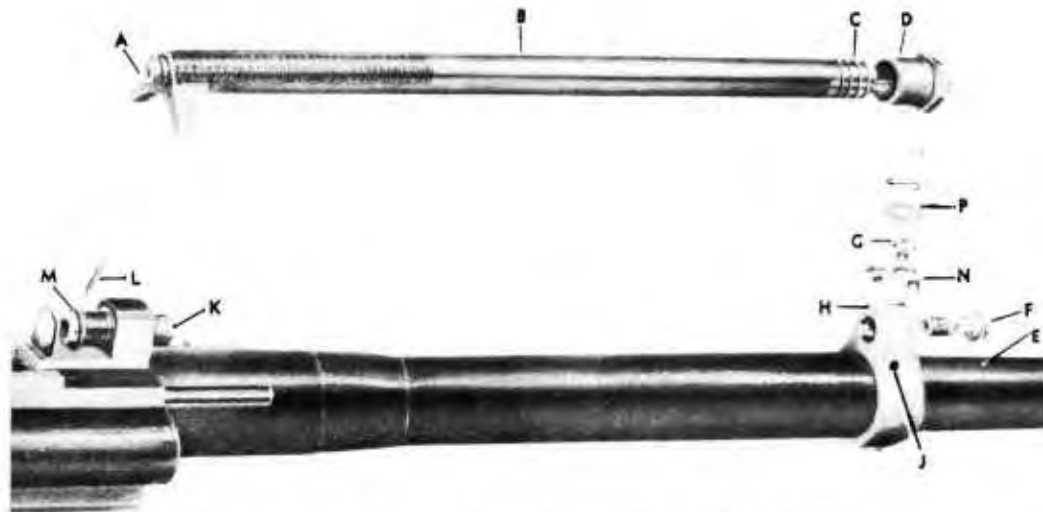

- | | |
|--------------------------------|------------------------------------|
| A — GAS CYLINDER SLEEVE SPRING | H — GAS CYLINDER BRACKET |
| B — GAS CYLINDER SLEEVE | J — GAS CYLINDER TAPER PIN |
| C — GAS CYLINDER PISTON | K — GAS CYLINDER GUIDE |
| D — GAS CYLINDER | L — SPLIT COTTER PIN |
| E — TUBE | M — GAS CYLINDER GUIDE LOCK WASHER |
| F — GAS CYLINDER VENT PLUG | N — GAS CYLINDER LOCK PLATE |
| G — GAS CYLINDER BRACKET PLUG | P — GAS CYLINDER LOCK WASHER |

RA PD 70368

Figure 79 — Gas Cylinder and Sleeve Group

shaped projection at the front of the tool (fig. 81). The sear buffer spring retaining tool should enter the hole in the sear block assembling tool.

(5) Turn the handle of the sear block assembling tool sufficiently to take the tension off the sear buffer spring retaining tool. Remove the retaining tool. Gradually turn the handle of the tool to release the tension of the springs. Remove the plungers and springs (fig. 82). If the special sear block assembling tool is not available, an ordinary vise will serve. If the retaining tool is not available, use a slightly tapered steel rod which nearly fills the hole.

h. Breechblock Locking Key. Remove the locking wire and unscrew the breechblock locking key plate screws. Remove the lock washers and the plate. Drive out the key with a soft hammer.

NOTE: The breechblock locking key is to be removed only for replacement.

20-MM AUTOMATIC GUN M1 AND
20-MM AIRCRAFT AUTOMATIC GUN AN-M2

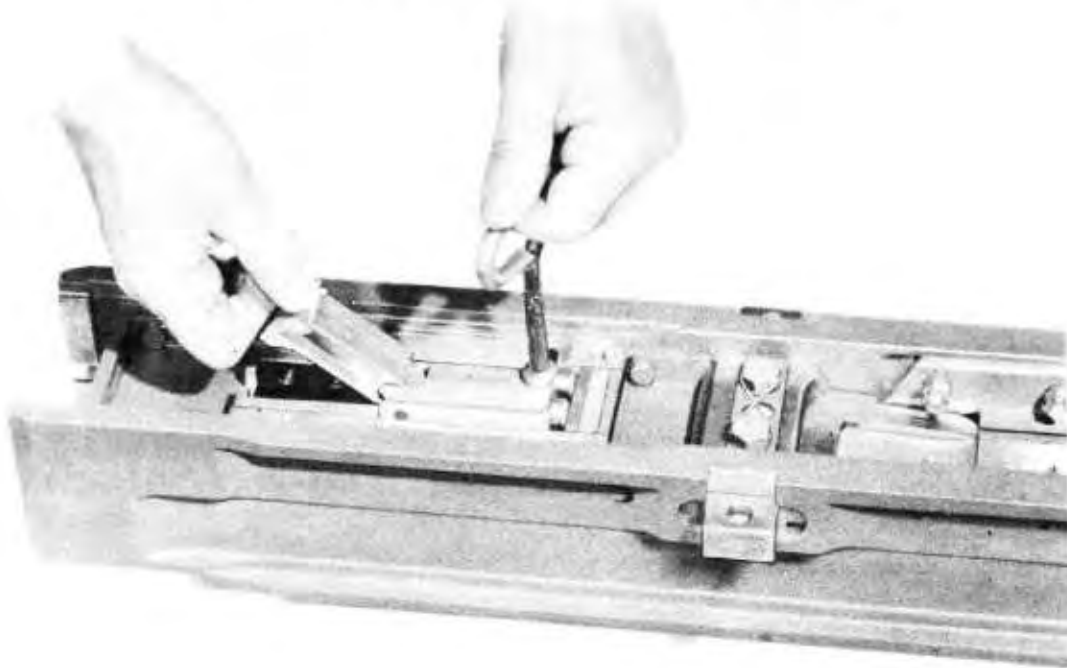

RA PD 10933

Figure 80 — Removing Sear Block Group from Receiver Plate

23. ASSEMBLY OF THE BASIC GUN.

a. Prior to assembly, all parts must be free of dirt, rust, and other extraneous matter. Metal parts in contact must be covered with a light film of lubricating oil. Assembly and replacement are in the reverse order of disassembly. However, the following instruction pertaining to certain assembly operations should be noted:



RA PD 10937

Figure 81 — Sear Block Group in Position in the Tool

DISASSEMBLY AND ASSEMBLY

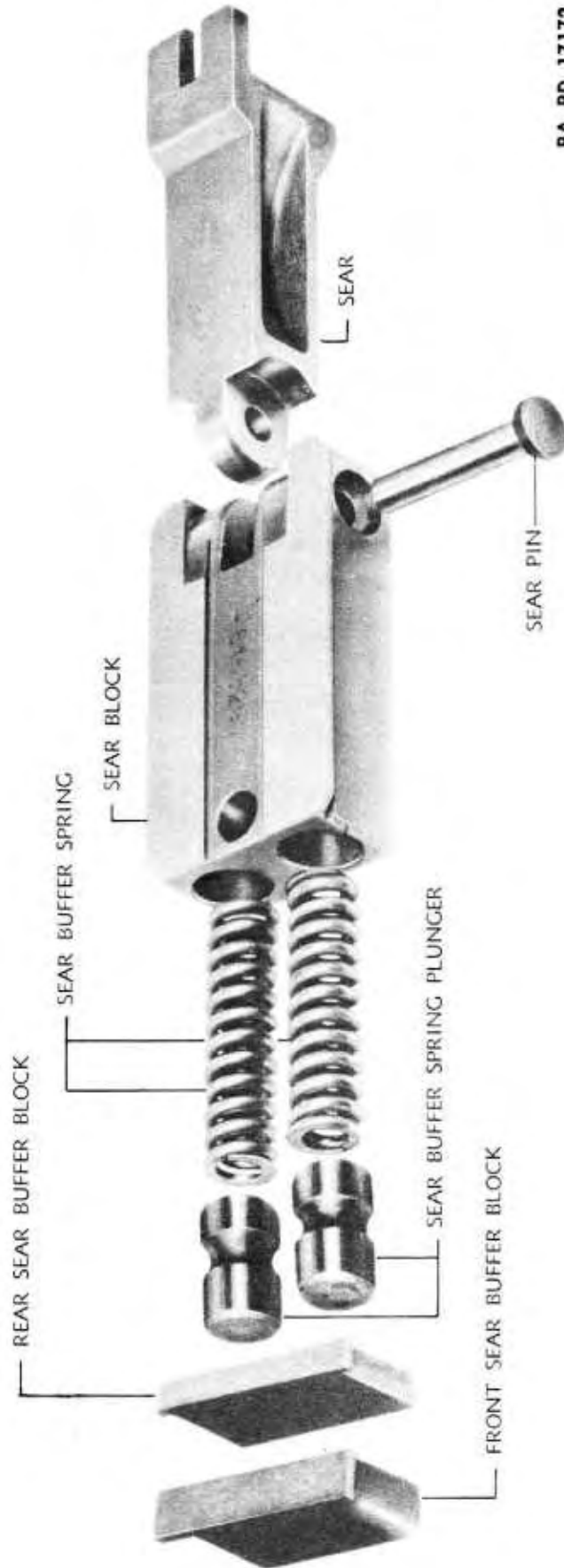

Figure 82 — Sear Block Group

20-MM AUTOMATIC GUN M1 AND
20-MM AIRCRAFT AUTOMATIC GUN AN-M2



RA PD 10819A

Figure 83 – Inserting the Driving Spring Group

(1) The breechblock lock must be assembled to the breechblock by forcing the breechblock slides rearward and, at the same time, exerting pressure against the lock until it is in the unlocked position. Hold the breechblock firmly in this position and push into the receiver as far as it will go so that the lock will not spring out of position (fig. 76).

(2) In assembling the rear buffer group, stake the threaded sleeve to the housing at three points. Extreme caution should be exercised, however, not to overstake, as difficulty may be experienced in removing the stake when it is necessary to replace the rear buffer spring.

(3) To assemble the driving spring and driving spring guide, push the breechblock forward to the locked position. Insert the driving spring assembling tool into the driving spring guide plunger. Slip the driving spring over the tool and plunger. Insert the driving spring guide into the spring so that the tool telescopes the guide tube. Insert the entire group into the receiver (rear buffer in place) (fig. 83), so that the head of the plunger rests against the back of the firing pin. Compress the driving spring and tighten the guide securely, using the special rear buffer wrench. Remove the driving spring assembling tool.

(4) In assembling and replacing the sear block group, proceed as follows: Insert the sear buffer springs in their recesses in the sear block. Replace the plungers with their hollow ends against the springs. Place the unit on the sear block assembling tool with the flanged side of the sear block up and with the radial bearing surface against the jaw of the tool. Compress the springs until the sear buffer spring retaining tool can be inserted to engage the grooves of the plungers (fig. 81). Remove the sear block and retaining tool from assembling tool. Attach the sear to the block so that the forked end of the sear is on the same side as the flanged side of the block. Do not remove the retaining tool until the group has been replaced in the gun.

(5) Assemble the gas cylinder group first without the spring and test for free movement of the piston in the cylinder. When this has been done, remove the gas cylinder guide, and install the spring.

DISASSEMBLY AND ASSEMBLY

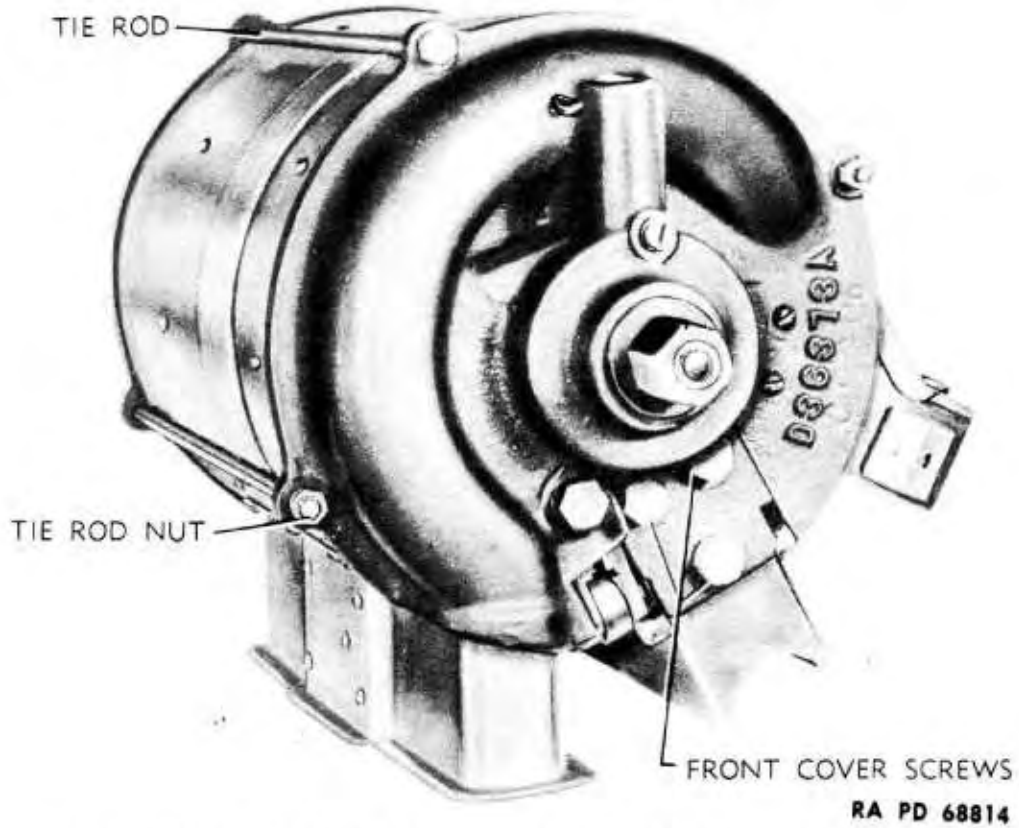

Figure 84 – 20-MM Feed Mechanism AN-M1 – Front View

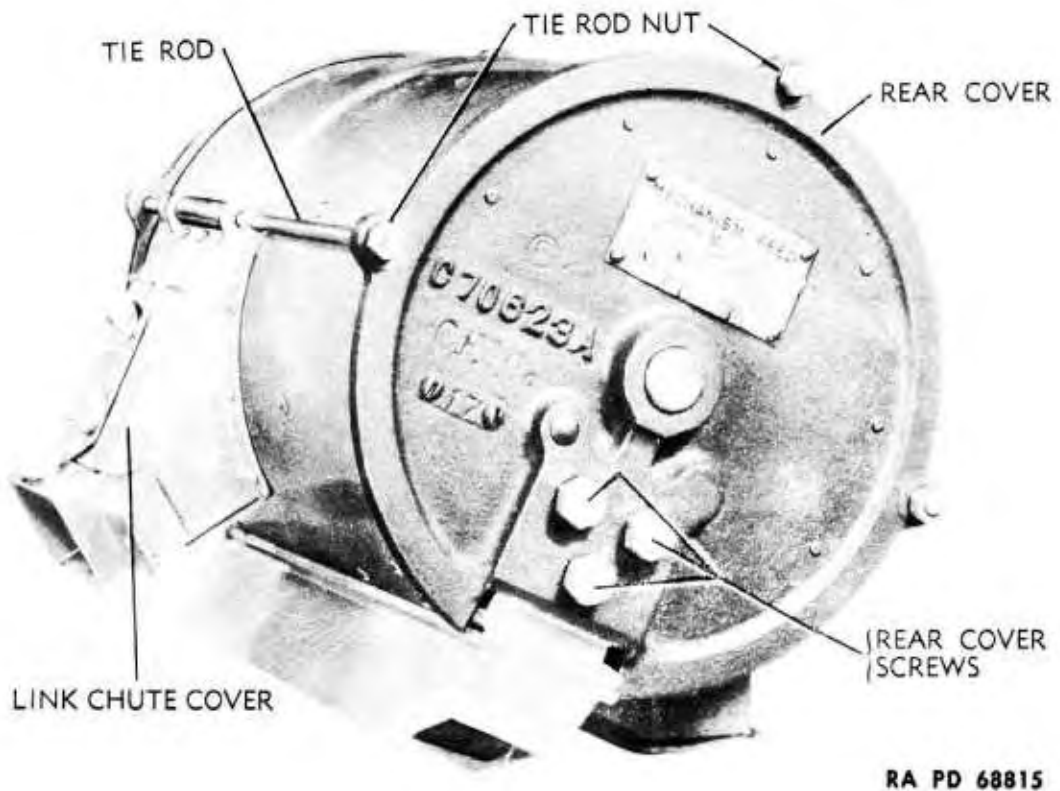
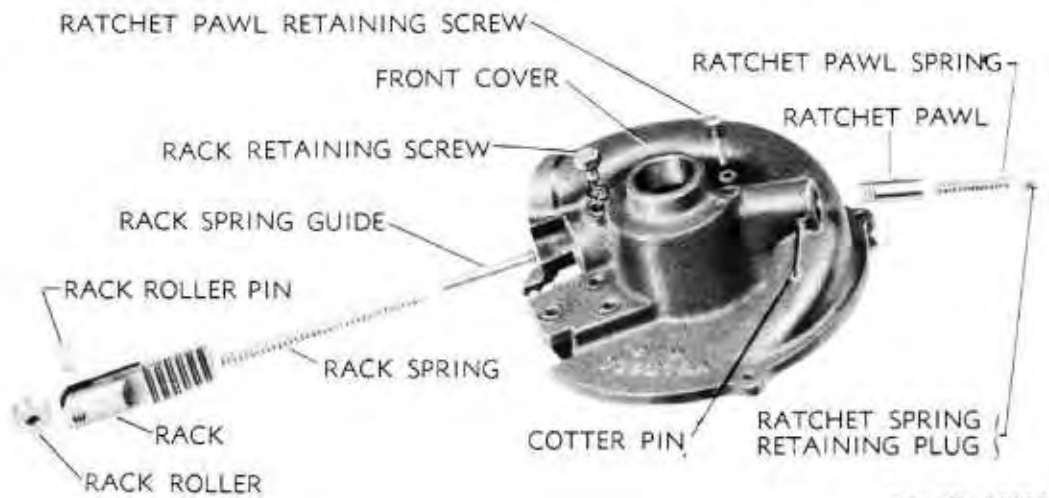

Figure 85 – 20-MM Feed Mechanism AN-M1 – Rear View

20-MM AUTOMATIC GUN M1 AND
20-MM AIRCRAFT AUTOMATIC GUN AN-M2



RA PD 68816

Figure 86 – Front Cover Group

(6) The gas cylinder should have at least a 0.01-inch clearance between the hexagonal shoulder and the top of the tube to allow for heat expansion. This is best done with a 0.010-inch shim or feeler gage.

24. DISASSEMBLY OF 20-MM FEED MECHANISM AN-M1.

a. Remove the front and rear cover screws and the washers. Remove the tie rod nuts. When the tie rod above the link chute is pulled out, the link chute cover and spring will be released (figs. 84 and 85).

b. Carefully loosen rear cover and remove it, taking care not to damage any of the parts. Remove the pin which secures the last round retainer spring and rear feed lever spring. Carefully loosen the case from the front cover. Pull the ends of the case out of the grooves in the mouth and withdraw the mouth. Remove the shaft assembly.

c. While holding the rack in place in the front cover, unscrew the rack retaining screw, and gradually release the rack assembly, rack spring, and the rack spring guide. Withdraw the hub with the driving spring case cover, the thrust spring, the ratchet segment, and driving spring ratchet from the front cover.

d. Remove the cotter pin, which secures the ratchet spring retaining plug, from the upper side of the front cover. Withdraw the plug and the tensioning ratchet pawl with the spring. Unscrew the tensioning ratchet pawl retaining screw (fig. 86).

e. Drift out the ratchet pin and remove the ratchet, ratchet segment, thrust spring, and driving spring case cover (fig. 87).

f. Drift the collar pin out of the shaft and slide off the following in the order listed:

DISASSEMBLY AND ASSEMBLY

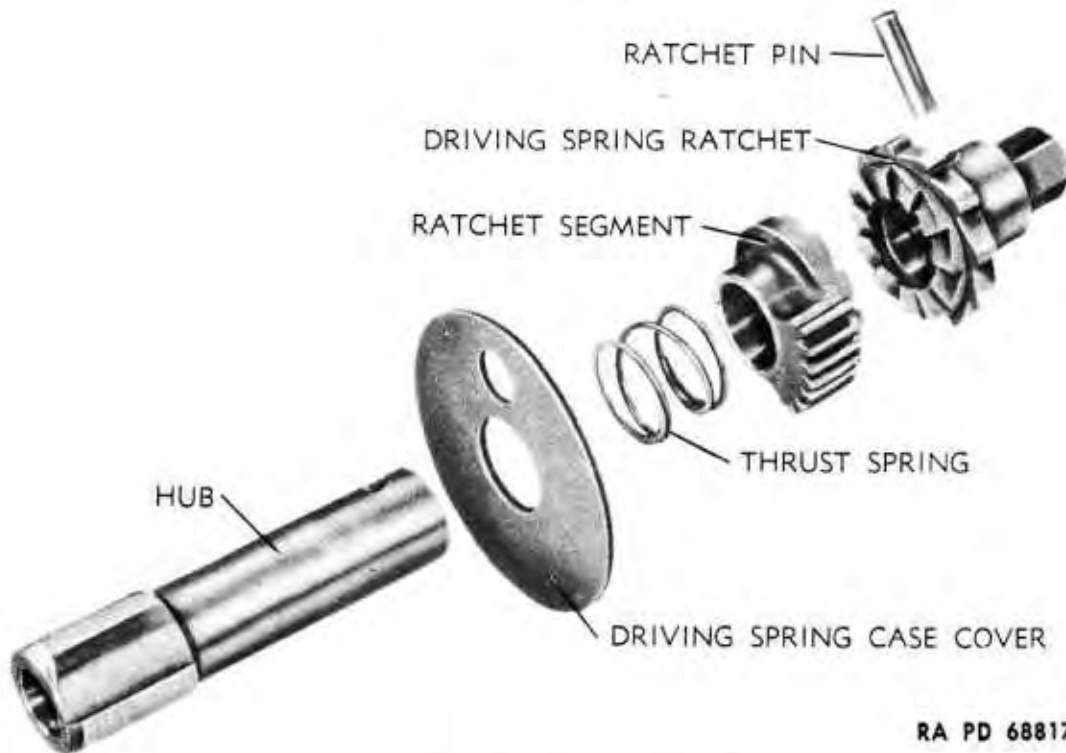

RA PD 68817

Figure 87 – Hub Group

- (1) Collar.
- (2) Rear feed lever.
- (3) Rear feed sprocket assembly.
- (4) Front feed lever assembly.
- (5) Center feed sprocket assembly.
- (6) Link ejector assembly.

g. Drift out the front feed sprocket bushing pin and slide off the front feed sprocket assembly.

h. Shaft assembly parts are shown in figure 88.

25. ASSEMBLY OF 20-MM FEED MECHANISM AN-M1.

a. Slip the driving spring case cover on the hub, placing it flat against the face of the bossed surface at one end of the hub. Follow with the thrust spring and ratchet segment. The flat of the segment should bear against the thrust spring. Place the ratchet on the hub and engage its teeth with the teeth on the segment. Align the ratchet pin hole with the hole in the hub and drive in ratchet pin.

b. Replace rack spring together with rack spring guide within the recess in the rack provided for it. Place this unit in the recess located

20-MM AUTOMATIC GUN M1 AND
20-MM AIRCRAFT AUTOMATIC GUN AN-M2

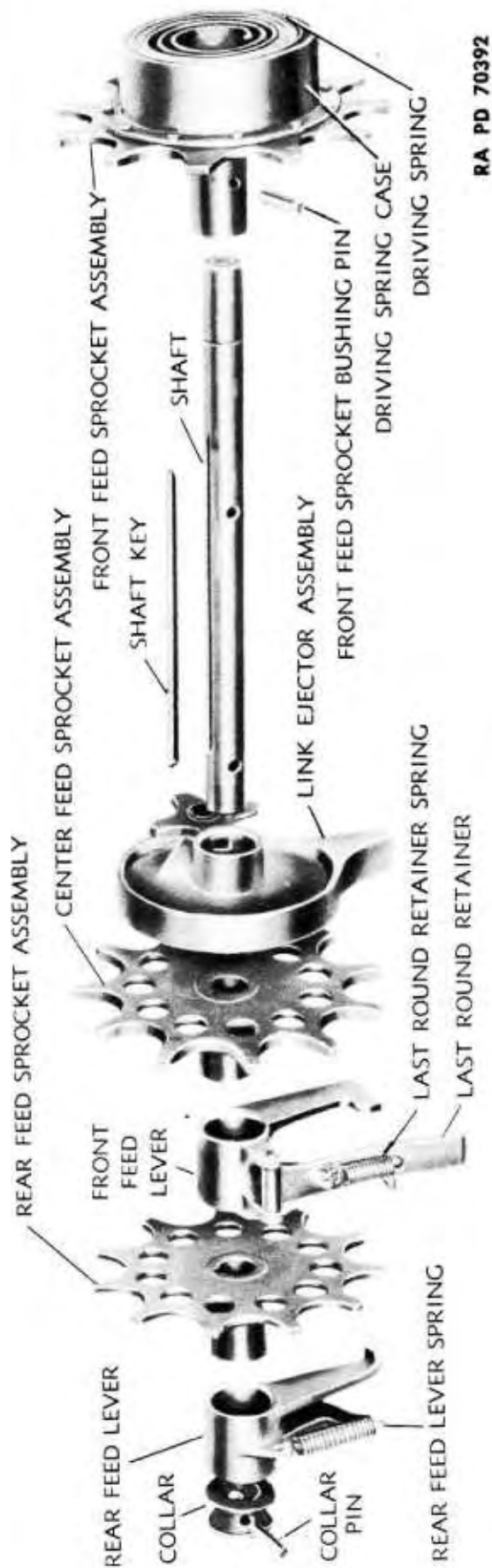

Figure 88 — Shaft Assembly

DISASSEMBLY AND ASSEMBLY



RA PD 68819

Figure 89 – Engaging Rack to Ratchet Segment

in the front cover. Position the rack so that the teeth face the central hole in the front cover. Insert the hexagonal end of the ratchet into the central hole of the front cover from the rear of the cover. Engage the rack and segment so that the first tooth on the rack goes between first and second teeth of the segment. This operation can be most advantageously accomplished by looking through the hole in the driving spring case cover (fig. 89). Fasten the rack assembly to the front cover with the rack retaining screw.

c. Insert the tensioning ratchet pawl into its recess in the top of the cover. The cut-out portion must face to the same side as the rack teeth. Aline it by replacing the tensioning ratchet pawl retaining screw. Insert the tensioning ratchet pawl spring into the hollow rear end of the pawl. Close the recess with the pawl spring retaining plug and secure the plug with the cotter pin.

d. Slip the driving spring case over the hub so that the hub engages the driving spring. Insert the shaft key into the keyway on the shaft. Insert the front end of the shaft (end with bronze bearing) into the front feed sprocket bushing. With one hand aline the hole of the front feed sprocket bushing with the hole of the hub, and with the other hand push in the shaft so that the shaft key alines with the keyway in the bushing (fig. 90). Aline the hole in the shaft with the hole in the bushing and insert the front feed sprocket bushing pin.

20-MM AUTOMATIC GUN M1 AND
20-MM AIRCRAFT AUTOMATIC GUN AN-M2



RA PD 68820

Figure 90 – Inserting Shaft into Hub

e. Slip the following onto the shaft in the order listed:

(1) Link ejector assembly. In the right-hand feed mechanism, the ejector should be to the left and the notched arm on the bracket should be down when looking forward along the shaft. In the left-hand feed mechanism the position is reversed.

(2) Center feed sprocket assembly with bushing to the rear (the center feed sprocket is thicker than the rear feed sprocket).

(3) Front feed lever assembly. In the right-hand feed mechanism the last round retainer is to the right. In the left-hand feed mechanism it is to the left.

(4) Rear feed sprocket assembly with bushing to the rear.

(5) Rear feed lever with flat arm to the rear.

(6) Collar with larger face adjacent to the flat arm of the rear feed lever. Drive in the collar pin to secure the collar to the shaft.

f. Attach last round retainer spring (smaller) to stud on last round retainer and rear feed lever spring (larger) to stud on rear feed lever.

g. Place the case over the shaft assembly, front end first. Slip the ends of the last round retainer spring and rear feed lever spring through

DISASSEMBLY AND ASSEMBLY

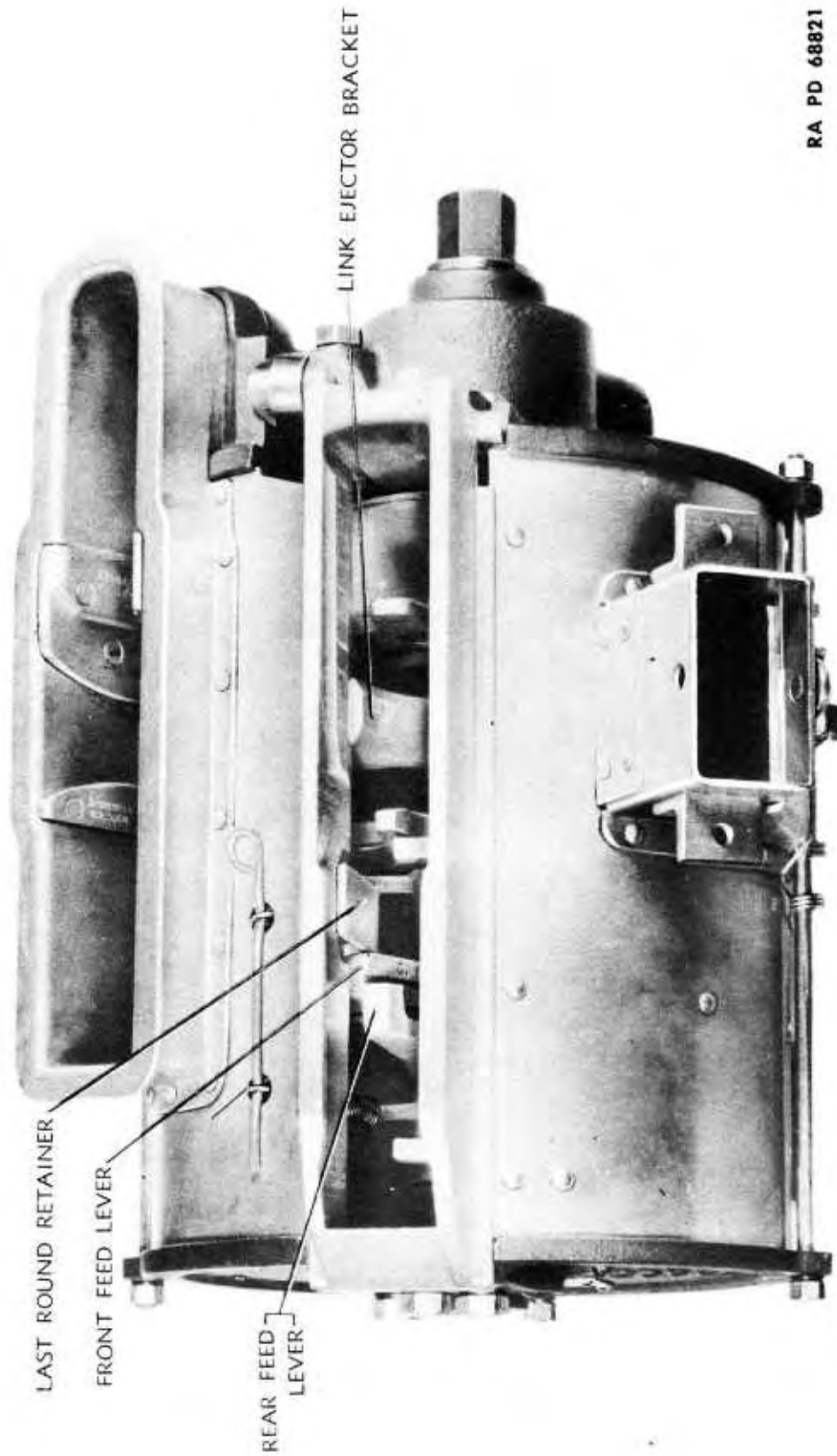

RA PD 68821

Figure 91 — Details in Assembling the Feed Mechanism

20-MM AUTOMATIC GUN M1 AND 20-MM AIRCRAFT AUTOMATIC GUN AN-M2

the small holes located in the rear of the case below the belt guide. Fasten the springs with the pin. The loop of the pin should be to the front.

h. Slip the mouth into position in the case, with the slanted end to the rear. Compress the case to hold the mouth securely. The last round retainer should extend downward within the mouth (fig. 91). The notch on the end of the link ejector should engage the right edge of the mouth in the right-hand feed mechanism and the left edge in the left-hand feed mechanism (fig. 91). The rear feed lever should be placed in a position whereby the lug on its front arm will mate with the lug of the adjacent arm of the front feed lever when the rear feed lever is turned in the direction of feed (fig. 91). Tap the case forward until the edges enter the grooves in the front cover. Place the rear cover on the rear end of the shaft. The rear feed lever should extend downward to the right of the rear feed stop in right-hand feed mechanism (and to the left in left-hand feed mechanism) when looking into the case with the mechanism right side up. Insert the tie rods through the front and rear covers. Attach first the tie rod that acts as a hinge for the link chute cover and spring. Compress the case until the edges enter the grooves in the covers. Fasten the tie rods with lock washers and nuts. Fasten the nuts gradually and uniformly. Fasten the mouth to the covers with lock washers and front and rear cover screws. The screws have the same diameter but differ in length. Use the *longer* screws for the *front* cover.

26. DISASSEMBLY OF 20-MM 60-ROUND MAGAZINE M1.

a. Remove all rounds from the magazine. Place the magazine in the magazine holder with the mouth up and the nut on the lower tie rod in the locating hole in the holder. If no magazine holder is available, use any other suitable retaining device.

b. Remove the cotter pin from the tensioning tube pin. Place a bar in the end of the tensioning tube and turn it to take the load off the tension tube pin. Remove the tube pin and carefully release the spring.

c. Unscrew the seven fixing screws and remove the front plate disk. Remove the spring casing with the spring and tensioning tube. Disengage the tensioning tube from the spring.

d. Remove the pin and collar from the rear of the feed arm axis tube. Turn the feed arm axis tube through a right angle so that the follower clears the hole in the front plate and remove the tube with feed arm and follower (fig. 92).

27. ASSEMBLY OF 20-MM 60-ROUND MAGAZINE M1.

a. Proceed in reverse order of disassembly.

DISASSEMBLY AND ASSEMBLY

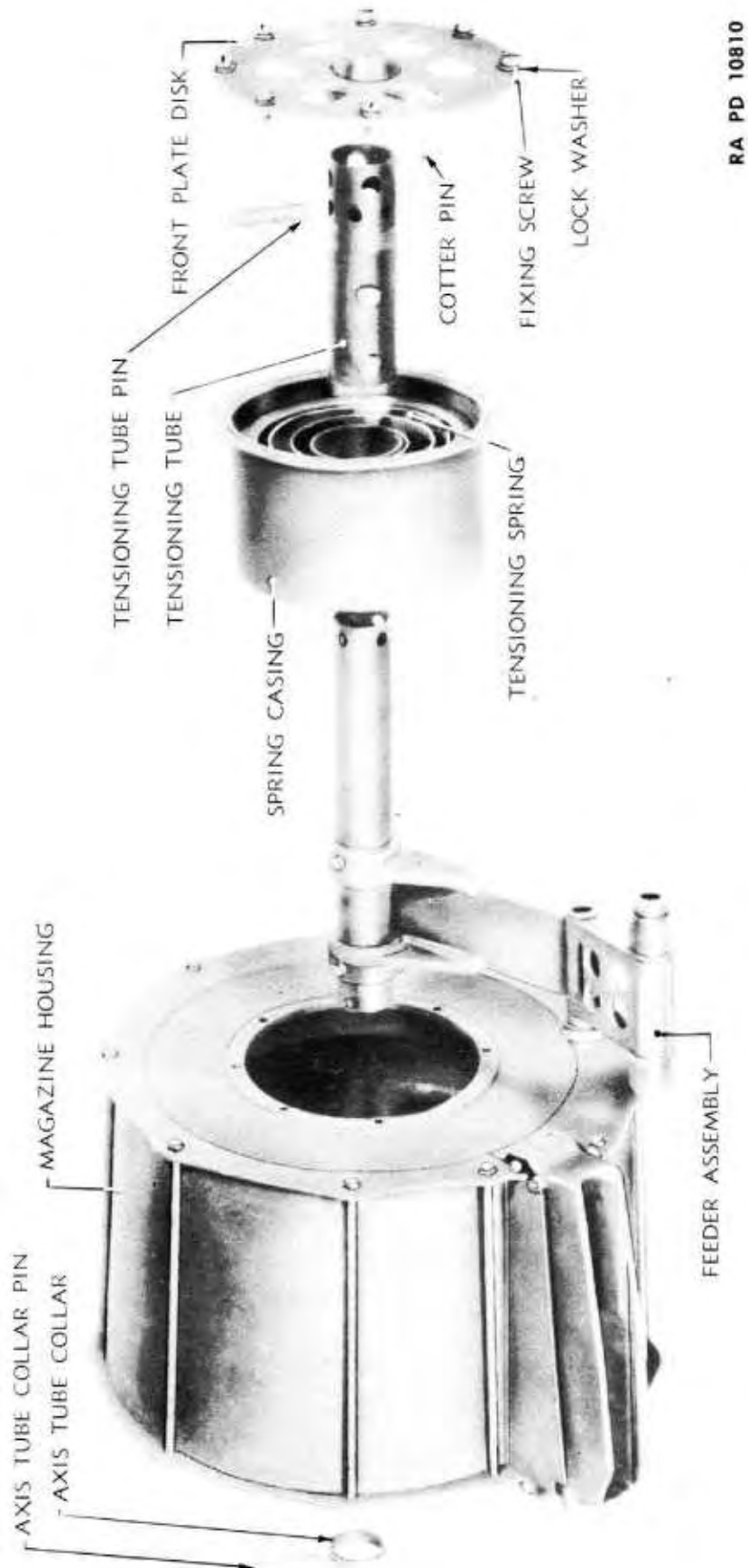

Figure 92 — 20-MM 60-round Magazine M1

RA PD 10810

20-MM AUTOMATIC GUN M1 AND
20-MM AIRCRAFT AUTOMATIC GUN AN-M2

Section V

MALFUNCTIONS AND CORRECTIONS

	Paragraph
General	28
Misfire	29
Other malfunctions and their corrections.....	30

28. GENERAL.

a. Proper care of the gun before and after firing will usually eliminate most stoppages. Stoppages or other malfunctions should be dealt with in accordance with instruction described in the following paragraphs. These instructions should be studied before any firing is done.

b. Immediately after flight, unload the gun and, if the breechblock is home, retract it by charging the gun. If a round is extracted during the charging, it indicates that the gun failed to fire. If a hydraulic charger is used, leave the pressure on so that there will be no risk of the breechblock moving forward until the pressure is released.

29. MISFIRE.

a. All stoppages will be considered misfires if the receiver is not visible. Immediately after the occurrence of a misfire, proceed as follows:

(1) **GROUND TESTING.** Wait 30 seconds from the time of occurrence of the misfire. Recharge the gun and remove the round from the vicinity of the aircraft.

CAUTION: If the gun is hot and the round cannot be removed from the chamber, the breechblock or bolt should be closed. It should not be opened until the hand can be placed on the breech or barrel without discomfort.

(2) **AIR TESTING.** If the weapon can be recharged, either manually or remotely, wait 30 seconds and then recharge. If the weapon cannot be recharged, no corrective action is possible.

(3) **COMBAT FIRING.** If recharging is possible, recharge immediately and continue firing.

NOTE: The possibility of a hangfire of more than 30 seconds after an attempt to fire is very remote in guns using fixed ammunition. The possibility of the propellant or the high-explosive filler being fired

MALFUNCTIONS AND CORRECTIONS

by the heat absorbed from a hot gun barrel increases with the length of time the round is in the gun. The safest time to remove a misfire is between 30 and 45 seconds after its occurrence.

30. OTHER MALFUNCTIONS AND THEIR CORRECTIONS.

a. Failure to Feed.

(1) CAUSES:

(a) Loss of tension in the feed mechanism driving spring due to insufficient recoil of the gun, improper magazine slide adjustment, broken driving spring in the feed mechanism, or broken parts in the anchoring mechanism of the magazine slide.

(b) Round jammed in the mouth of the feed mechanism due to loss of tension in the feed mechanism driving spring, deformed feed mouth, excessive friction in feed mechanism, or a belt jam in the feed chute or ammunition container.

(c) Link jammed or belt broken, due to defective links.

(d) Insufficient recoil of bolt caused by faulty unlocking or defective ammunition.

(2) REMEDIES.

(a) Check the tension of the feed mechanism driving spring with a torque wrench if available. If the tension has dropped from the original setting, check the magazine slide setting which should be $\frac{1}{16}$ inch to the rear of the scribe mark on the receiver. Inspect the anchor mechanism for loose or broken parts. Check tension of the rack spring and replace if broken or weak. When testing the tension of the driving spring determine whether the driving spring of the feed mechanism is broken. If it is, replace the feed mechanism. If the feed mechanism has lost tension and the loss in tension cannot be attributed to any of the above causes, it may be assumed that there was insufficient recoil of the gun to operate the feed mechanism. In this case, the front and rear mountings should be carefully inspected for any signs of binding or restricted movement of the gun in recoil. If it is impractical to test-fire the gun to determine the resulting recoil travel, replace the adapter with a new one.

(b) If a round is jammed in the mouth of the feed mechanism, it may have been caused by a loss of tension in the feed mechanism. Check as described in subparagraph a (1) above. If the tension has not dropped, inspect the mouth of the feed mechanism for burs, dents, or other deformations. If the mouth of the feed mechanism is in good shape, check the link chute for jammed links which may be caused by a weak or broken link chute cover spring, or by weak and defective links. Remove jammed links with screwdriver.

**20-MM AUTOMATIC GUN M1 AND
20-MM AIRCRAFT AUTOMATIC GUN AN-M2**

CAUTION: Do not insert finger in link chute to clear jammed link as unwinding of spring may result in injury. Excessive friction in the feed mechanism may be caused by improper lubrication of the feed mechanism and of the links and rounds (par. 13 a (3) and 33 g). Check the feed chute for free motion of belt. Check the ammunition container. Friction or jams in the feed chute or container may prevent feeding.

(c) If the gun fails to pick up a new round, it may be caused by a jam as described in step (2) above. Also it may be caused by faulty ammunition, which provides insufficient recoil energy, or by faulty unlocking of the breechblock. Check the bore to see that there is no projectile in the tube. Check the gas cylinder and piston for free operation. If the piston is bent or deformed on the end, replace parts to insure free unlocking action. Broken belts are usually caused by defective links. If the breechblock remains in the retracted position when the firing mechanism is actuated, inspect the electric trigger and all connections thereto.

b. Failure to Fire Chambered Round.

(1) **CAUSES.** Failure to fire may be caused by:

- (a) Defective firing pin.
- (b) Defective ammunition.
- (c) Insufficient protrusion of firing pin.

(2) **REMEDIES.**

(a) Examine the firing pin for breakage or cracks (indicated in figure 93). If firing pin is cracked or broken, it should be replaced.

(b) Examine the extracted round. If the primer of the round is deeply indented, it must be treated as a misfire and immersed in water. If the primer is not indented or only slightly indented, examine the firing pin as above, inspect the driving spring and breechblock slide springs, and examine the receiver for foreign matter. Also examine the breechblock slides for swaging (fig. 93) which may produce "light hits" by interfering with bolt action:

c. Failure to Extract.

(1) **CAUSES.** Failure to extract is generally caused by:

- (a) Broken extractor or extractor spring.
- (b) Carbon deposit in chamber.
- (c) Dirty ammunition.

(2) **REMEDIES.**

(a) When failure to extract occurs, the bolt may be found fully closed with a spent case in the chamber. Generally, most failures to

MALFUNCTIONS AND CORRECTIONS

extract can be remedied by charging the gun except when the extractor, extractor spring, or extractor pin are broken. When this occurs, the case should be pushed out from the muzzle end. The broken extractor, spring or pin should be replaced.

(b) Sometimes the empty case will be left in the chamber with the extractor ripping through the base of the cartridge case. When this occurs, the bolt will generally attempt to feed a fresh round into the chamber. It will then be necessary to remove this round before the spent case can be removed. If the jammed round is broken, be sure to remove all powder that may be strewn around in the receiver.

(c) A dirty chamber can be caused by carbon deposit from the oil film on the rounds. If this occurs, clean the chamber.

(d) *Failure to Eject.* This is caused by a broken ejector stud or ejector which should be replaced.

(e) *Run-away Gun.* This may be caused by a broken sear spring or sear which should be replaced. To stop a run-away gun on a ground test, jam a screwdriver in the belt; to stop a run-away gun in an airplane in the air, activate the charger on "SAFE" or pull back rapidly on the control stick.

20-MM AUTOMATIC GUN M1 AND
20-MM AIRCRAFT AUTOMATIC GUN AN-M2

Section VI

CLEANING AND LUBRICATION

	Paragraph
General	31
Cleaning of guns received from storage	32
Care preparatory to firing	33
Care after firing	34
Preparation for storage	35

31. GENERAL.

a. Proper functioning and accuracy of firing depend largely on care, cleaning, and oiling. The weapon should be checked daily for cleanliness and lubrication. The following instructions should be carefully observed:

(1) Use OIL, lubricating, preservative, special, for the lubrication of all aircraft guns under all service conditions, regardless of the temperatures to be encountered. The oil is preferably applied by means of a cloth dampened with the oil. On guns other than aircraft, OIL, lubricating, preservative, light, may be used.

32. CLEANING OF GUNS RECEIVED FROM STORAGE.

a. Guns which have been stored in accordance with instructions given in paragraph 35 will be coated with either OIL, lubricating, preservative, medium, or COMPOUND, rust-preventive, light. Guns received from storage will usually be coated with a COMPOUND, rust-preventive, heavy. Use SOLVENT, dry-cleaning, to remove all traces of the compound. Apply the solvent with rag swabs to large parts, and as a bath for small parts. Take care to remove the compound from all recesses in which springs or plungers operate. Be careful to remove all traces of compound from the gas part in the tube and the gas cylinder plug. After removing all traces of the compound, allow the parts to dry and then wipe with a clean dry rag.

b. Persons handling parts after such cleaning should wear gloves to avoid leaving finger marks which are usually acid and start corrosion. SOLVENT, dry-cleaning, will attack and discolor rubber gloves.

33. CARE PREPARATORY TO FIRING.

a. Before the day's firing, the following instructions should be carefully followed in order to insure proper functioning of the gun.

CLEANING AND LUBRICATION

- b. Remove the breechblock.
- c. Run clean patches through the bore and chamber to remove all dirt and oil.
- d. Thoroughly clean all metal parts and lightly oil with OIL, lubricating, preservative, special.
CAUTION: Do not oil the bore and chamber before firing because dangerous pressures may develop.
- e. Lubrication should be applied lightly because oil has a tendency to collect dirt which may act as an abrasive on the operating parts.
- f. After the gun has been cleaned and oiled as described above, assemble the gun and wipe all outer surfaces with a lightly oiled rag.
- g. Feed lubrication. Before installing feed mechanism on the ground, dip the whole mechanism in OIL, lubricating, preservative, special, and allow to drain, being sure to get oil in the specified filter on the front of driving spring hub.

34. CARE AFTER FIRING.

- a. Thorough cleaning after firing is extremely important and shall be performed as soon as possible. The bore and other portions exposed to primer fouling, such as the front end of the bolt and receiver portions to the rear of the chamber, shall be thoroughly cleaned of primer salts using CLEANER, rifle bore. The corrosive primer salts are water soluble, and are not soluble in petroleum distillates.
- b. Immediately after firing or as soon as possible, run several wet patches impregnated with CLEANER, rifle bore, through the bore from the breech end. If the CLEANER, rifle bore, is not available, use warm soapy water or warm water alone. Remove the patch from the cleaning rod and attach the cleaning brush. Run the brush through the bore several times. Make certain the brush goes all the way through before reversing the direction. Remove the brush and run several patches wet with clean water through the bore and chamber again. Follow this with dry patches until they come out clean and dry. Failure to remove all traces of bore cleaner from the receiver and bolt is apt to result in malfunctioning of the gun at low temperatures because the cleaner contains water. Other methods of cleaning primer salts, such as the use of steam or hot solutions may be employed if proper control is maintained to complete removal of moisture from all parts of the gun, and the bore is lubricated immediately thereafter.
- c. After the bore and chamber have been cleaned, remove the breechblock and clean with SOLVENT, dry-cleaning. Clean the receiver with SOLVENT, dry-cleaning. Then wipe dry and oil as described in paragraph 31.

**20-MM AUTOMATIC GUN M1 AND
20-MM AIRCRAFT AUTOMATIC GUN AN-M2**

35. PREPARATION FOR STORAGE.

a. OIL, lubricating, preservative, special, has rust-preventive properties, but is not recommended as a rust-preventive for guns stored for extended periods, since frequent inspection and reoiling is required. Where guns must be maintained ready for immediate installation or use, it may be used subject to the following periodic inspection and reoiling:

(1) The gun shall be inspected every 4 days if installed in aircraft stored outdoors, and every 7 days if installed in aircraft stored indoors. Adverse weather conditions may require more frequent inspection. Guns having parts treated with protective coatings require less frequent inspection. If inspection reveals signs of corrosion the preservative coating should be renewed.

b. When installed guns are not to be fired for a month or more, they shall be removed, disassembled, cleaned, and dipped in OIL, lubricating, preservative, medium. Guns thus oiled shall be inspected at least every 7 days if stored outdoors and every 20 days if stored indoors. More frequent inspection may be necessary under adverse climatic conditions.

c. For the preservation of guns over very long storage periods when frequent inspection is impractical the guns shall be removed, disassembled, and thoroughly coated with COMPOUND, rust-preventive, light. This compound is applied by heating to temperature from 150 F to 180 F and briefly dipping the parts therein. Reassemble and store, applying the compound to spots where it has been removed during handling. Complete removal of all traces of this compound prior to reoiling for use is essential. Removal by vapor methods and immersion in SOLVENT, dry-cleaning, is prescribed.

d. **Specifications and Stock Numbers of Lubricants and Preservatives.**

(1) OIL, lubricating, preservative, special, Navy Specification OS 1361; US Army Specification AXS 777; ASO Stock No. R14-O-2852 (1-qt container); ASO Stock No. R14-O-2856 (5-gal container).

(2) OIL, lubricating, preservative, medium, Navy Specification OS 1363; US Army Specification AXS 674; ASO Stock No. R14-O-2832 (1-qt container); ASO Stock No. R14-O-2834 (5-gal container).

(3) COMPOUND, rust-preventive, light, US Army Specification 2-84B; ASO Stock No. R14-C-260 (5-lb container); ASO Stock No. R14-C-261 (25-lb container).

(4) CLEANER, rifle bore, US Army Specification RIXS 205; ASO Stock No. R51-S-4794 (6-oz container); ASO Stock No. R51-S-4796 (1-qt container).

(5) SOLVENT, dry-cleaning, Federal P-S-661a.

Section VII

INSPECTION

	Paragraph
General	36
Inspection of gun	37
Inspection of feed mechanisms	38
Inspection of chargers	39
Inspection of sear actuating mechanisms	40
Inspection of adapters	41

36. GENERAL.

a. The purpose of inspection is to determine the condition of the gun and any repairs, adjustments, or replacements that may be required to maintain the gun in proper condition for efficient operation. Thorough, systematic inspection at regular intervals is the best insurance against an unexpected gun break-down at the critical moment when maximum performance is absolutely necessary. Never let your materiel run down; keep it in first class fighting condition by vigilant inspection and prompt maintenance.

37. INSPECTION OF GUN.

a. These inspections are routine and should be performed after every firing session without removing the gun from the airplane.

b. **General Condition of Gun.** Experience has shown that certain parts of the gun are subject to failure more frequently than others. Complete inspection should be carried out periodically, but the following parts and assemblies must be carefully cleaned and inspected after every day's firing. The exterior of the gun should be inspected for any scoring, evidence of binding in recoil travel, or broken locking wire or cotter pins which would result in loose parts or assemblies.

c. **Functioning of the Gun.** Remove the feed mechanism from the gun. Charge the gun and actuate the firing mechanism several times, using a dummy or empty shell in the chamber to cushion the shock. If any binding or sluggish movement of parts is noted, determine the cause and stone or replace parts as necessary to produce free motion. Use only a fine stone on parts and do not remove any more metal than is absolutely necessary.

20-MM AUTOMATIC GUN M1 AND
20-MM AIRCRAFT AUTOMATIC GUN AN-M2

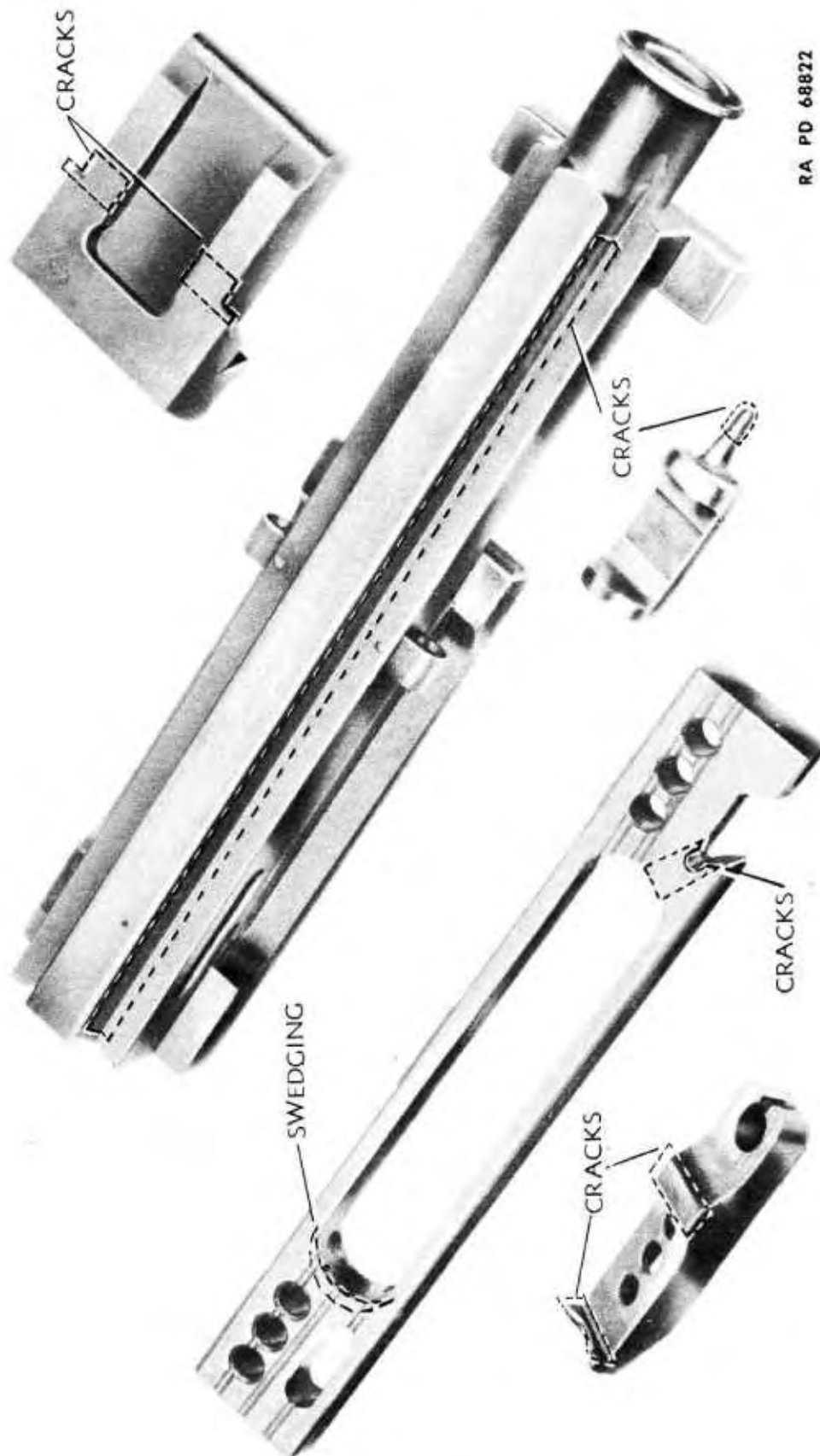

Figure 93 — Defects in Breechblock Parts

INSPECTION

d. **Driving Spring.** Test tension of driving spring and examine for sharp kinks or offset of coils. Measure free length (26.5 in.). If free length is less than 23.5 inches, the spring should be replaced.

e. **Rear Buffer.** Examine rear buffer for rough or bruised surfaces on washer, threaded sleeve or dovetail connections.

f. **Breechblock.** Disassemble the breechblock and clean it with SOLVENT, dry-cleaning. Examine front face of bolt for erosion and wear, and note condition of firing pin hole. Look for cracks on the shoulders of the bolt (fig. 93). Examine breechblock slides for burrs or rough surfaces on cam. Look for swaging and cracks (fig. 93). Note condition of breechblock slide key. Examine firing pin for pitting, deformation, or cracks (fig. 93). Examine the extractor for signs of cracks over extractor pin hole, and chips or burrs on the lip (fig. 93). Examine breechblock lock for condition of cams on both sides, and for wear or roughness on locking surface. Check under side of lock for wear and cracks (fig. 93).

g. **Magazine Slide.** Check whether magazine slide is correctly adjusted (par. 14). Check for free motion of the slide in the guideways.

h. **Gas Cylinder and Sleeve Group.** Check for carbon or rust on gas cylinder and sleeve, bracket, and plugs. Note if gas cylinder vent plug is loose.

38. INSPECTION OF FEED MECHANISMS.

a. Examine exterior of feed mechanism for loose or broken parts. Test whether the tie rods and nuts are tight.

b. If the case or covers are dented or damaged, and if the lips on the mouth are bent, the feed mechanism is unserviceable.

c. Remove any burrs from the mouth, from the pins at the front of the mouth, and from the latch plate at the rear of the mouth.

d. If the feed mechanism has been disassembled, check the cam in front cover for burrs and scores. Test whether the feed sprockets rotate freely. Then, raise the link chute cover and see if spring is broken. Check whether rack roller rotates freely.

39. INSPECTION OF CHARGERS.

a. **Hydraulic Charger M1.** See that the taper pin which retains the spring guide assembly is firmly staked to the charger housing. Check for leakage around charger cylinder. If the charger cylinder leaks excessively around the piston, the packings should be replaced. This is done by removing the cylinder and piston assembly from the charger housing on the gun with the special spanner wrench provided with the charger. Separate the piston from the cylinder and remove the pack-

20-MM AUTOMATIC GUN M1 AND 20-MM AIRCRAFT AUTOMATIC GUN AN-M2

ings by unscrewing the nut on the end of the piston tube. Install new packings between the follower and the seat, and fasten with the nut and a cotter pin. The nut should be tightened until the packing swells sufficiently to prevent leakage around the piston, but not too tight so that excessive binding will result. (In an emergency, the nut may be tightened to swell old packings enough to stop leakage, but the packings should be replaced as soon as possible.) Exercise care to keep all parts free from dirt. If dirt is permitted to get into the cylinder chamber, the highly polished wall surface may become scored and cause excessive wear of the packings and eventual leakage. In assembling the piston to the cylinder, special care should be taken to guide the packings into the cylinder so that the sealing edge of the packings is not damaged, as this will cause leakage at low pressures.

40. INSPECTION OF SEAR ACTUATING MECHANISMS.

a. Electric Trigger AN-M1.

(1) The Electric Trigger AN-M1 is manufactured as an integral unit, and if any malfunction occurs, the whole unit should be replaced and the damaged unit returned to ordnance maintenance personnel or to the nearest supply point for replacement.

(2) When the trigger control is removed from the gun, be sure that the base plate is clean and free from burrs before assembling the trigger to the gun.

b. Sear Mechanism M1.

(1) Check fit of mechanism to receiver of gun. Check sear spring housing for looseness, and examine interior of housing for foreign matter or rough edges on the opening.

(2) Test tension of sear spring.

(3) Test functioning of safety lever.

(4) Remove the two nuts from bowden connection shaft and examine the parts for wear, rust, and broken or cracked bushings.

(5) Test tension of bowden connection shaft spring.

41. INSPECTION OF ADAPTERS.

a. It is important to check the tube sleeve nut which may be loose even though a detent is used. Remove the detent and tighten the nut securely. If the detent shows signs of wear, replace it with a new one.

b. **20-mm Adapter AN-M1 or M6.** Since this adapter itself is constructed as a unit, there are no adjustments or repairs that can be made. If the adapter fails to function properly, replace it with a new adapter and return the damaged adapter to ordnance maintenance personnel or to the nearest supply point for replacement.

Section VIII

AMMUNITION

	Paragraph
General	42
Nomenclature	43
Classification	44
Identification	45
Care, handling, and preservation	46
Authorized rounds	47
Preparation for firing	48
Cartridge, HE-I, Mk. I, w/FUSE, P.D., 253 Mk. I-II, 20-mm guns M1, AN-M2, and Br. H.S. /A/	49
Cartridge, AP-T, M75, 20-mm guns M1, AN-M2, and Br. H.S. /A/	50
Cartridge, ball, 20-mm guns M1, AN-M2, and Br. H.S. /A/	51
Fuzes	52
Fuze, P.D., 253 Mk. I or Mk. II	53
Packing and marking	54
Field report of accidents	55

42. GENERAL.

a. The ammunition for these guns is issued in the form of fuzed complete rounds of fixed ammunition. The term "fixed," used in connection with ammunition, signifies that the propelling charge is not adjustable and that the round is loaded into the gun as a unit. The propelling charge is assembled loosely in the cartridge case which is crimped rigidly to the projectile. A complete round comprises all the ammunition components used to fire a weapon once. After firing, the cartridge case is extracted and ejected; then the next round is loaded into the gun, all automatically.

43. NOMENCLATURE.

a. Standard nomenclature is used herein in all references to specific items of issue. Its use for all purposes of record is mandatory.

44. CLASSIFICATION.

a. Dependent upon the type of projectile, the ammunition is classified as high-explosive-incendiary, armor-piercing, or ball. The high-explosive-incendiary projectile contains both a high-explosive and an incendiary filler. The armor-piercing projectile is a solid shot, containing a tracer element for observation of fire, that is, for showing the gunner the path of the projectile in flight. The ball projectile is inert, and is provided for use against personnel and light materiel targets.

20-MM AUTOMATIC GUN M1 AND
20-MM AIRCRAFT AUTOMATIC GUN AN-M2

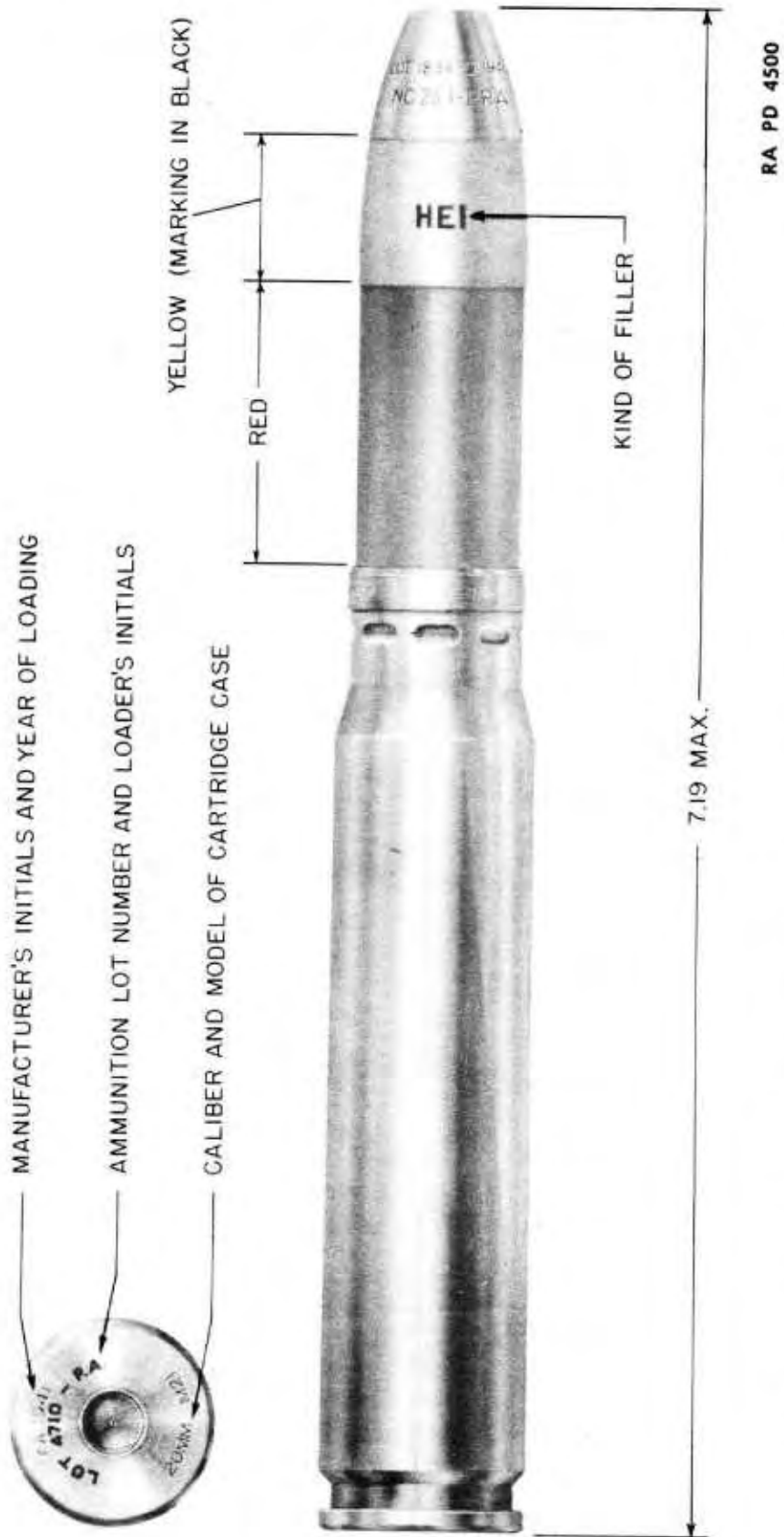

Figure 94 — Cartridge, HE-I, MK. I, W/Fuze, P.D., 253 MK. I-II, 20-MM Guns M1, AN-M2, and Br. H.S. /A/

AMMUNITION

45. IDENTIFICATION.

a. **General.** Ammunition, including components, is completely identified by means of painting and marking (including ammunition lot number). Other essential information may be obtained from the marking. See figures 94, 95, and 96 and the paragraphs below.

b. **Mark or Model.** To identify a particular design, a model designation is assigned at the time the design is classified as an adopted type. This model designation becomes an essential part of the standard nomenclature of the item, and is included in the marking of the item. The model designation consists of the letter "M" followed by an arabic numeral. Modifications are indicated by adding the letter "A" and the appropriate arabic numeral. Thus, "M1A1" indicates the first modification of an item for which the original model designation was "M1." An exception exists in the case of some models of 20-mm ammunition which are designated "Mark," abbreviated "Mk.," followed by a Roman numeral. The unusual nomenclature of some rounds is due to the fact that some of the names have come from the British, some from the U. S. Navy, and some from U. S. Army Ordnance.

c. **Ammunition Lot Number.**

(1) When ammunition is manufactured, an ammunition lot number, which becomes an essential part of the marking, is assigned in accordance with pertinent specifications. This lot number is stamped or marked on every complete round and on all packing containers. It is required for all purposes of record, including reports on condition, functioning, and accidents, in which the ammunition is involved. To provide for the most uniform functioning, all of the rounds of any one lot of affixed ammunition consists of:

- (a) Projectiles of one lot number.
- (b) Fuzes of one lot number.
- (c) Primers of one lot number.
- (d) Propellant powder of one lot number.

(2) Therefore, to obtain the greatest accuracy in any firing, successive rounds should be from the same ammunition lot whenever practicable.

d. **Painting and Marking.**

(1) **PAINTING.** Projectiles are painted to prevent rust and, by the color, to provide a ready means of identification as to type. The projectiles of the ammunition described herein are painted as follows:

High-explosive-incendiary	Yellow ogive, red body; marking in black
Armor-piercing	Black; marking in white
Ball (inert)	Black; marking in white

20-MM AUTOMATIC GUN M1 AND
20-MM AIRCRAFT AUTOMATIC GUN AN-M2

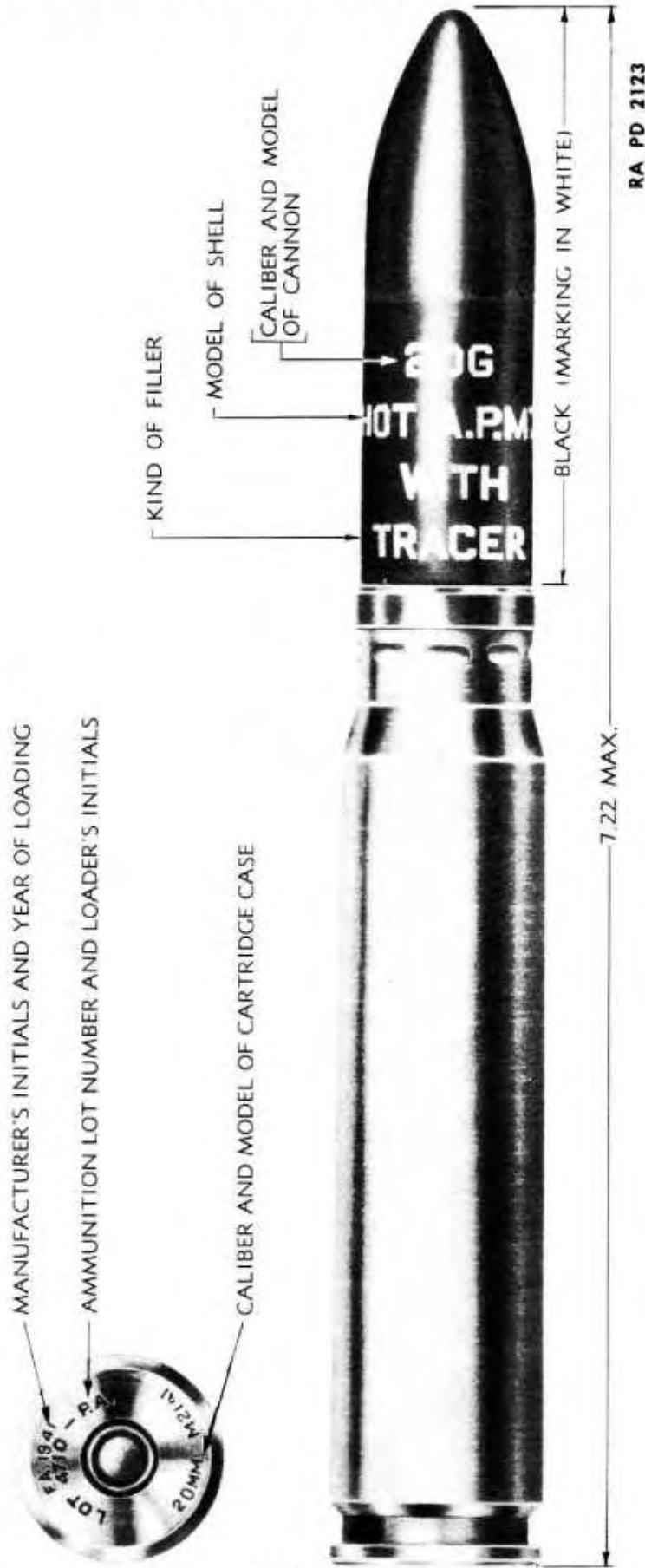

Figure 95 — Cartridge, AP-T, M75, 20-MM Guns, M1, AN-M2, and Br. H.S. /A/

AMMUNITION

NOTE: The above color scheme is not wholly in agreement with the basic color scheme described in TM 9-1900.

(2) MARKING. For purpose of identification, the following is marked or stamped on the components of each round of fixed ammunition described herein.

(a) *On the Projectile (Stenciled):*

On the H.E.I. projectile: Kind of filler.

On the A.P. projectile:

Caliber and type of weapon in which fired.

Model of projectile.

"WITH TRACER."

(b) *On the Projectile (Stamped in the Metal):*

On the H.E.I. and practice projectiles (on the body):

Manufacturer's initials or symbol.

Lot number of empty projectile.

Month and year of manufacture.

On the A.P. projectile (on the base end):

Manufacturer's initials or symbol.

Lot number projectile.

Year of manufacture.

Caliber and designation of shot.

(c) *On the Head of the Cartridge Case:*

Stenciled:

Ammunition lot number.

Loader's initials.

Stamped in the metal:

Designation and caliber of case.

Manufacturer's initials or symbol.

Year of manufacture, in full.

(d) *On the Fuze (Stamped in the Metal):*

Model and designation of fuze.

Manufacturer's initials or symbol.

Loader's lot number.

Year of loading.

20-MM AUTOMATIC GUN M1 AND
20-MM AIRCRAFT AUTOMATIC GUN AN-M2

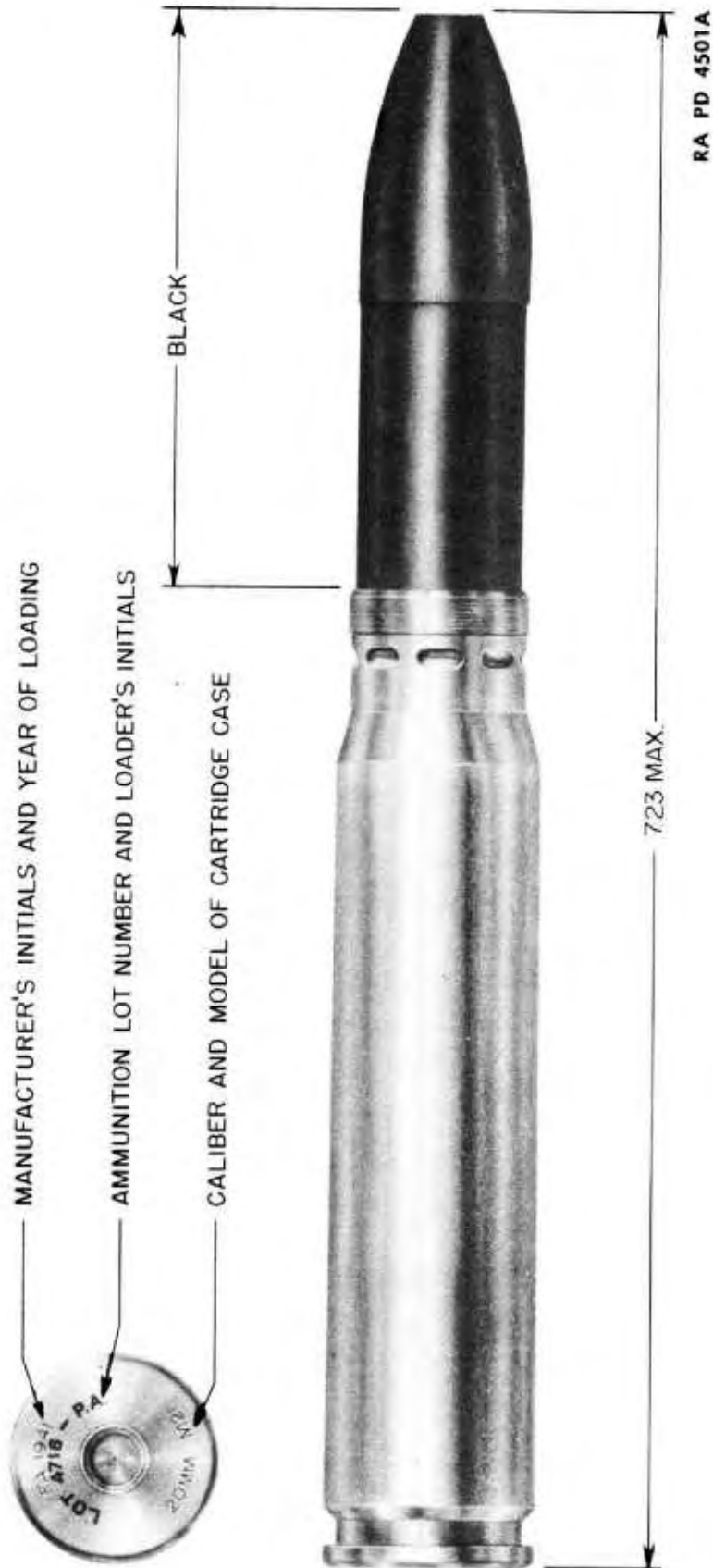

Figure 96 — Cartridge, Ball, 20-MM Guns, M1, AN-M2, and Br. H.S. /A/

AMMUNITION

46. CARE, HANDLING, AND PRESERVATION.

a. Complete rounds are packed to withstand conditions ordinarily encountered in the field. Ammunition for the 20-mm automatic guns is packed in cartons (10 per carton), which in turn are inclosed in metal-lined wooden boxes. Since explosives are adversely affected by moisture and high temperature, the following precautions should be observed:

(1) Do not break moisture-resistant seals until ammunition is to be used.

(2) Protect ammunition, particularly fuzes, from high temperatures, including the direct rays of the sun. More uniform firing is obtained if all the rounds are at the same temperature.

b. Handle ammunition with care at all times. The explosive elements in primers and fuzes are highly sensitive to shock and high temperature.

c. Do not attempt to disassemble any complete round or fuze.

d. The complete round should be freed of foreign matter such as sand, mud, grease, etc., just before loading into the magazine or belt. If it gets wet or dirty, it should be wiped clean at once.

e. Although the use of oil or grease on ammunition is generally prohibited, in the case of ammunition for these guns it is necessary to oil the cartridge case in order to prevent jamming. By means of a cloth wrung out of OIL, lubricating, preservative, special, spread a light film of oil evenly over the body of the cartridge case just prior to insertion of the round into the magazine or belt. Extreme care should be taken to prevent oil from getting on the primer or joint at the mouth of the cartridge case. If OIL, lubricating, preservative, special, is not available, use OIL, lubricating, preservative, light. Preferably, only one day's supply of ammunition should be lubricated at a time. Rounds oiled for firing and not fired at the same day, should be wiped dry to prevent the accumulation of dust and grit, and the seepage of oil around the primer and mouth of the cartridge case. Such rounds will be used first in subsequent firing; they must be oiled again before use.

f. Do not handle duds because their fuzes are armed; they will not be moved or turned but will be disposed of in accordance with TM 9-1900.

47. AUTHORIZED ROUNDS.

a. The ammunition authorized for use in these guns is shown in the following table. The M1, AN-M2, and Br. H.S. /A/ Guns are chambered alike; hence, fire the same ammunition. The nomenclature (standard nomenclature) completely identifies the round.

20-MM AUTOMATIC GUN M1 AND
20-MM AIRCRAFT AUTOMATIC GUN AN-M2

Table 1
Ammunition for the Gun,
20-mm, M1, AN-M2, and Br. H.S. /A/

Nomenclature	Action of Fuze	Approximate Weight of Projectile as Fired
Service Ammunition		
CARTRIDGE, HE-I, Mk. I, w/ FUZE, P.D., 253 Mk. I-II, 20-mm guns, M1, AN-M2, and Br. H.S. /A/.....	Superquick	0.29 lb
CARTRIDGE, AP-T, M75, 20-mm guns, M1, AN-M2, and Br. H.S. /A/.....	None	0.37 lb
CARTRIDGE, ball, 20-mm guns, M1, AN-M2, and Br. H.S. /A/.....	None	0.29 lb

HE-I, High-explosive-incendiary; AP-T, armor-piercing, w/tracer P.D., point-detonating.

48. PREPARATION FOR FIRING.

a. As issued, the complete rounds are ready for firing after removal of packing; however, it is necessary to oil the rounds as described in paragraph 46 e and to load the rounds into the feed mechanism or the magazine

49. CARTRIDGE, HE-I, MK. I, W/FUZE, P.D., 253 MK. I-II, 20-MM GUNS M1, AN-M2, AND BR. H.S. /A/.

a. This complete round (fig. 94) is for use from aircraft against light materiel targets, functioning with both explosive and incendiary effect. After the shell penetrates the target, the high-explosive filler is detonated, the shell is shattered, and the incendiary composition is ignited. The round consists of a primer and a propelling charge, contained in a brass cartridge case which is crimped rigidly to the projectile, and a fuze which is of the superquick type. The projectile contains a total of 0.03 pound of high-explosive and incendiary fillers. The round is 7.19 inches long and weighs 0.57 pound. The propelling charge, weighing 0.07 pound, consists of loose flashless nonhygroscopic (FNH) smokeless powder contained in the cartridge case.

50. CARTRIDGE, AP-T, M75, 20-MM GUNS M1, AN-M2, AND BR. H.S. /A/.

a. This complete round (fig. 95) is for use from aircraft against armored targets. It consists of a primer and a propelling charge contained in a brass cartridge case which is crimped rigidly to the projectile. The projectile is a solid steel shot, and contains a red tracer

AMMUNITION

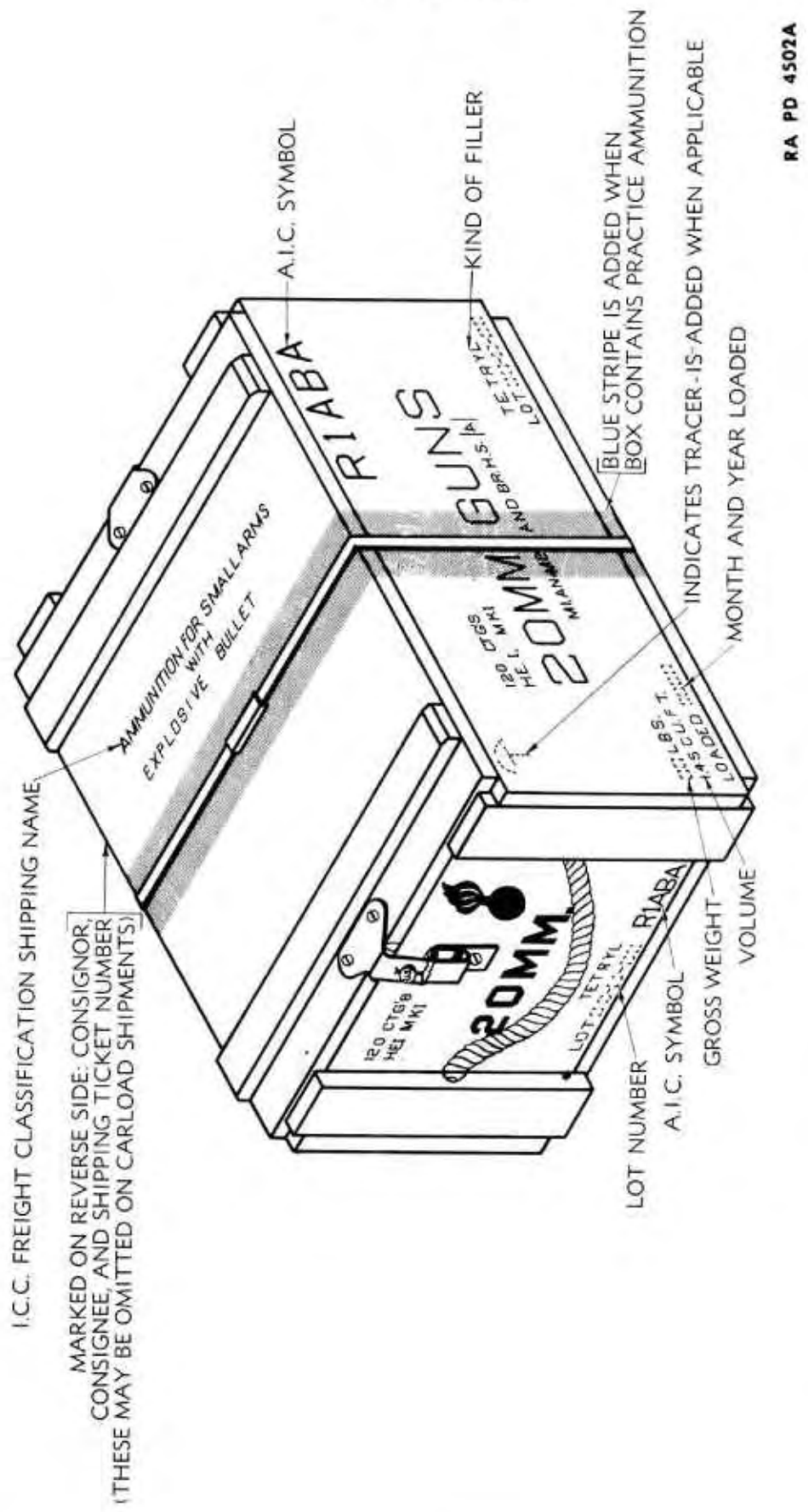

RA PD 4502A

Figure 97 — Packing Box for Ammunition for 20-MM Guns M1, AN-M2, and Br. H.S. / A/

20-MM AUTOMATIC GUN M1 AND
20-MM AIRCRAFT AUTOMATIC GUN AN-M2

composition in its base. The round is 7.22 inches long and weighs 0.64 pound. The propelling charge, weighing 0.07 pound, consists of loose flashless nonhygroscopic (FNH) smokeless powder contained in the cartridge case.

51. CARTRIDGE, BALL, 20-MM GUNS M1, AN-M2, AND BR. H.S. /A/.

a. This complete round (fig. 96) is for service firing from aircraft against personnel and light materiel targets and for practice. It consists of a primer and propelling charge contained in a cartridge case which is crimped rigidly to the steel projectile. The projectile contains no explosive and has no fuze. It is similar in shape and ballistic properties to the point-fuzed high-explosive incendiary projectile. The round is 7.23 inches long and weighs 0.57 pound. The propelling charge, weighing 0.07 pound, consists of loose flashless nonhygroscopic (FNH) smokeless powder contained in the cartridge case.

52. FUZES.

a. A fuze is a mechanical device used with a projectile to explode it at the time and under the circumstances desired. A fuze designed to function upon impact with a target is classified as the impact type. Fuzes designed to function on impact with a light material target, such as an airplane wing, are further classified as superquick fuzes.

CAUTION: Fuzes will not be disassembled. Any attempt to disassemble fuzes in the field is dangerous and is prohibited except under specific direction of the Chief of Ordnance.

53. FUZE, P.D., 253 MK. I or MK. II.

a. These are instantaneous percussion fuzes of the impact type, for penetration of light armor and functioning on heavier armor of aircraft. Like some fuzes used with small caliber ammunition, these fuzes do not come within the definition of boresafe. They are used with 20-mm high-explosive aircraft ammunition and are issued assembled to the high-explosive incendiary projectile of the fixed complete round described in paragraph 49 and shown in figure 94. The MK. II /A/ fuze is similar to the MK. I /A/ except that the MK. II /A/ is more sensitive. It contains a washer type disk whereas the MK. I /A/ contains a solid disk.

54. PACKING AND MARKING.

a. **Packing.** The ammunition for the GUN, automatic, 20-mm, M1, AN-M2, and Br. H.S. /A/ is packed 10 rounds per fiber carton,

AMMUNITION

12 cartons (120 rounds) per sealed metal-lined packing box (fig. 97). The following data are considered suitable for estimating weight and volume requirements:

	Weight	Volume
Complete round, HE-I, w/o packing material..	0.57 lb	—
Complete round, A.P., w/o packing material..	0.64 lb	—
Complete round, Ball, w/o packing material....	0.57 lb	—
120 HE-I or Ball rounds in fiber cartons in metal-lined packing box.....	94.8 lb	1.48 cu ft
120 A.P. rounds in fiber cartons in metal-lined packing box	103.0 lb	1.48 cu ft
Over-all dimensions of packing box (in.): $18\frac{1}{16} \times 13\frac{3}{16} \times 10\frac{1}{32}$		

b. Marking for Shipment.

(1) Packings for shipment are marked as follows (fig. 98):

(a) Name and address of consignee (or code marking).

(b) List and description of contents.

(c) Code symbol (A.I.C.) as published in standard nomenclature lists and OFSB 3-14.

(d) Gross weight in pounds; displacement in cubic feet.

(e) The number of the package.

(f) Ordnance insignium and escutcheon.

(g) Name or designation of consignor preceded by the word "FROM."

(h) Lot number.

(i) Month and year loaded.

(j) Inspector's stamp.

55. FIELD REPORT OF ACCIDENTS.

a. When an accident involving the use of ammunition occurs during training practice, the procedure prescribed in section VII, AR 750-10, will be observed by the ordnance officer under whose supervision the ammunition is maintained or issued. Where practicable, reports covering malfunctions of ammunition in combat will be made to the Chief of Ordnance, giving the type of malfunction, type of ammunition, the lot number of the complete rounds or separate-loading components, and conditions under which fired,

20-MM AUTOMATIC GUN M1 AND
20-MM AIRCRAFT AUTOMATIC GUN AN-M2

Section IX

ORGANIZATIONAL SPARE PARTS AND ACCESSORIES

	Paragraph
Organizational spare parts	56
Accessories	57

56. ORGANIZATIONAL SPARE PARTS.

a. These are extra parts provided with the materiel for replacement of those parts which are most likely to become unserviceable through breakage or wear. Organizational spare parts are for use by the using arms in making minor repairs. The sets of organizational spare parts should be kept as complete as possible at all times and kept clean and oiled to prevent rust. The allowances of organizational spare parts are prescribed in SNL A-47.

57. ACCESSORIES.

a. **General.** Gun accessories are those required for operating, disassembling, assembling, and for cleaning, care, and preservation. They also include covers, tool roll, etc., necessary for storage and protection when the equipment is not in use. Accessories should not be used for purposes other than as prescribed. Those accessories, the names or general characteristics of which indicate their use, are not described in detail here. Accessories embodying special features or having special uses are described in the following paragraphs and illustrated in figure 98.

(1) **20-MM LINK LOADING MACHINE M4.** The ammunition linking machine provides a quick and accurate means of combining 20-mm cartridges and disintegrating links to form a continuous belt. The machine consists essentially of a base with guides for 11 links and 10 cartridges. A handle operates a pusher bar which pushes the cartridges into the links to form a belt of 10 rounds.

(2) **CLEANING STAFF M13 (20-MM).** The rod consists of four metal sections threaded to each other and provided with a T-shaped handle at one end and a brush assembly at the other end (bore brush M25 or M28). The brush assembly can be replaced with a plug end for use with a patch, or a loop end for a flannelette or other cleaning rag.

ORGANIZATIONAL SPARE PARTS AND ACCESSORIES

TM 9-227
57

LIBRARY
1946
U.S. PATENT OFFICE

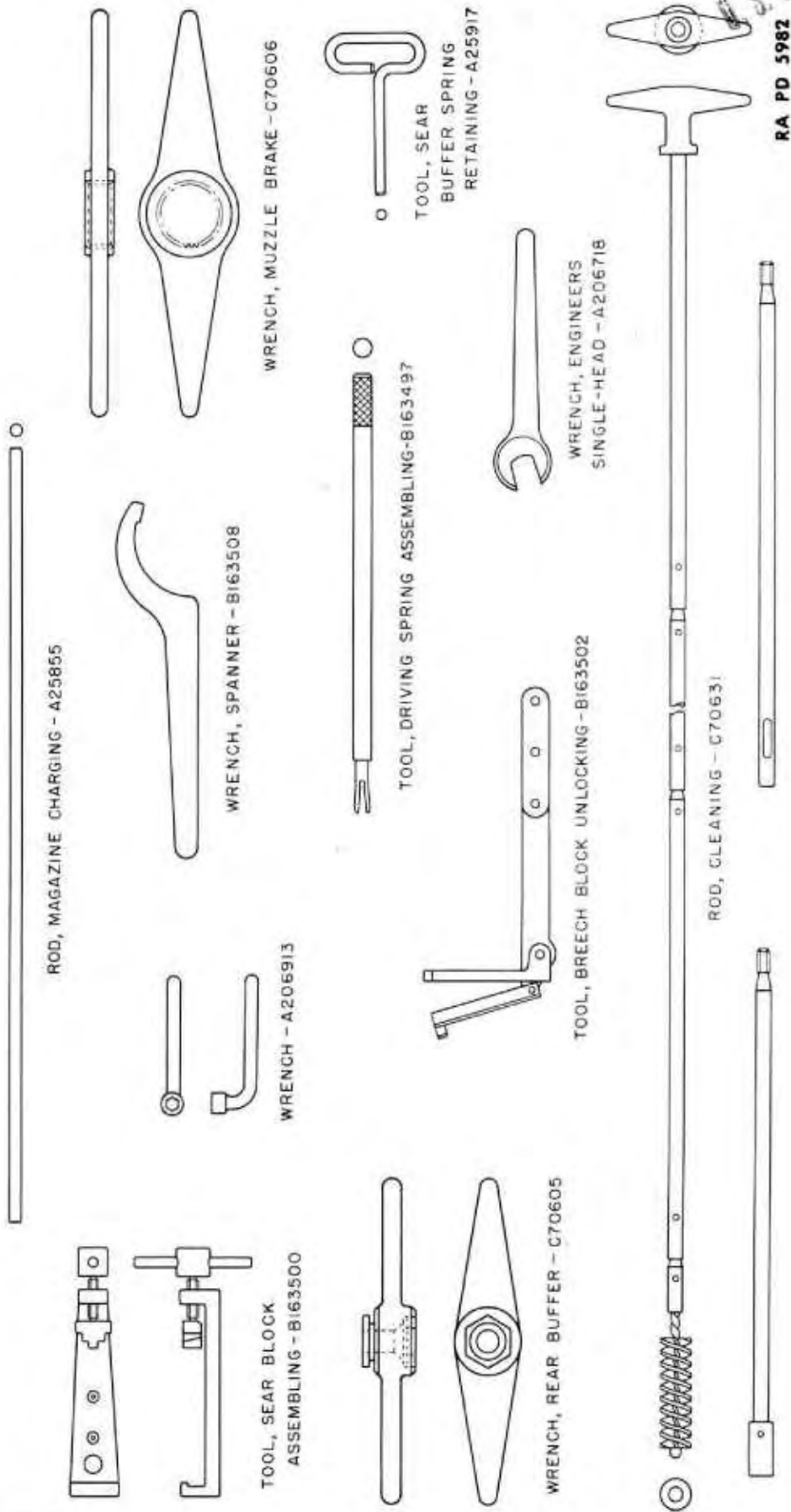

Figure 98 — 20-MM Automatic Gun Accessories

56839

**20-MM AUTOMATIC GUN M1 AND
20-MM AIRCRAFT AUTOMATIC GUN AN-M2**

(3) **DRIVING SPRING ASSEMBLING TOOL.** This is a steel rod with a split stud at one end. The studded end is inserted through the driving spring guide tube into the recess in the outer end of the driving spring guide plunger, to aid in removing and replacing the plunger in the bolt.

(4) **SEAR BLOCK ASSEMBLING TOOL.** This vise-like tool is used for compressing and releasing the sear buffer springs in disassembly and assembly of the sear block group.

(5) **SEAR BUFFER SPRING RETAINING TOOL.** This is a rod bent to form an oval handle at one end, and slightly tapered at the end of the straight portion. The tapered end is inserted into the hole of the sear block to engage the grooves on the sear buffer spring plungers, and thus hold the sear buffer springs under compression. The sear block group can then be removed or replaced in the receiver as a unit.

(6) **BREECHBLOCK UNLOCKING TOOL.** This lever with two arms pivoted at one end is designed to place on top of the bolt body in the receiver. The hook on one arm engages the front face of the right breechblock slide so that when the lever is operated, the slides are forced rearward to unlock the breechblock.

(7) **ENGINEER'S SINGLE-HEAD WRENCH.** This open-end wrench is provided to fit the gas cylinder guide and gas cylinder vent plug.

(8) **REAR BUFFER WRENCH.** One face of this tool has a hexagonal socket to fit the driving spring guide head; the other face has four equally spaced projections to engage keyways in the flange of the rear buffer sleeve.

(9) **SPANNER WRENCH.** This spanner wrench is used to turn the mounting sleeve nut in adjusting the compression of the recoil spring.

(10) **MUZZLE BRAKE WRENCH.** This wrench has internal splines to engage the external splines on the muzzle brake when disassembling and assembling. The tool can also be used for removing and replacing the muzzle thread protector.

(11) **SOCKET HEAD WRENCH ($\frac{7}{16}$ -INCH).** This wrench is used for removing or tightening the screws on sear mechanism M1 or electric trigger AN-M1.

Section X

STORAGE AND SHIPMENT

	Paragraph
Preparation for storage and shipment.....	58
Packaging	59
Removal of preservatives.....	60

58. PREPARATION FOR STORAGE AND SHIPMENT.

a. **Preparation of Parts.** If the gun is provided with the sear mechanism M1, prepare the gun for storage and shipment by inverting the inner bowden connection bushing so that this inner bushing fits into the outer bowden connection bushing (figs. 99 and 100). This is to prevent the bowden connection shaft from being operated and to prevent the bushing from being damaged. Remove the muzzle brake and place the thread protector in position. Remove the electric trigger AN-M1 if it is secured to the gun.

b. **Cleaning.** Clean the gun with SOLVENT, dry-cleaning, or with soapy water so as to remove shop coating, dirt, and other foreign substances from all surfaces. Thoroughly dry the gun before application of COMPOUND, rust-preventive, light.

c. **Application of Rust-preventive Compound.** Immediately after the gun is cleaned, brush or slush lightly on the outside of the gun COMPOUND, rust-preventive, light.

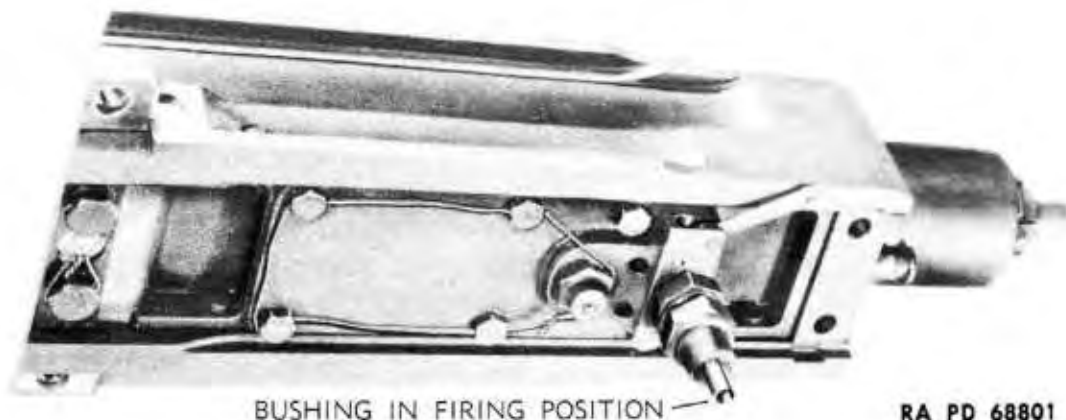

BUSHING IN FIRING POSITION —

RA PD 68801

Figure 99 — Bushing in Firing Position

20-MM AUTOMATIC GUN M1 AND
20-MM AIRCRAFT AUTOMATIC GUN AN-M2

59. PACKAGING.

a. Pack the gun in a box similar to that shown in figure 101. Make this box of 1-inch lumber to the following dimensions:

Length	95 in.
Width	7 ³ / ₄ in.
Depth	8 ³ / ₈ in.

b. The weight of the box with contents will be 158 pounds. The box shall be lined with waterproof paper and shall be strapped with either three-round wire straps (No. 14 gage) or three flat steel straps (³/₈- x 0.020-in.).

60. REMOVAL OF PRESERVATIVES.

a. Remove preservatives by cleaning all surfaces with SOLVENT, dry-cleaning.

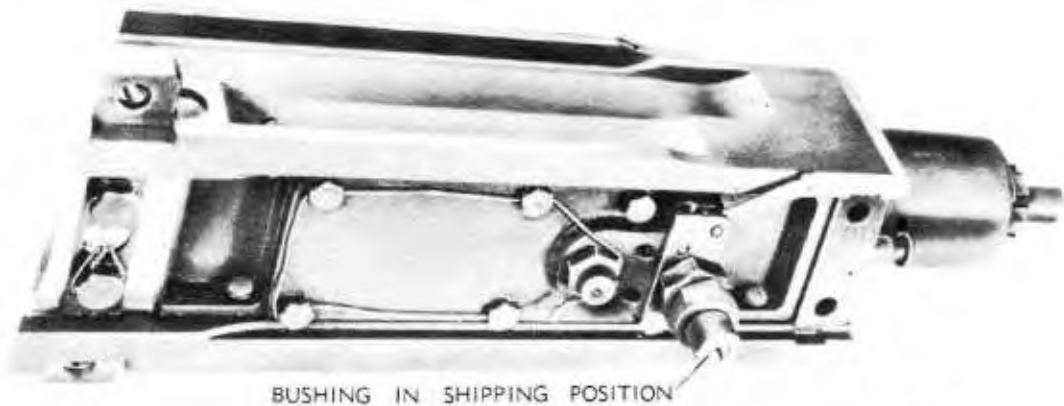

BUSHING IN SHIPPING POSITION

RA PD 68800

Figure 100 – Bushing in Shipping Position

STORAGE AND SHIPMENT

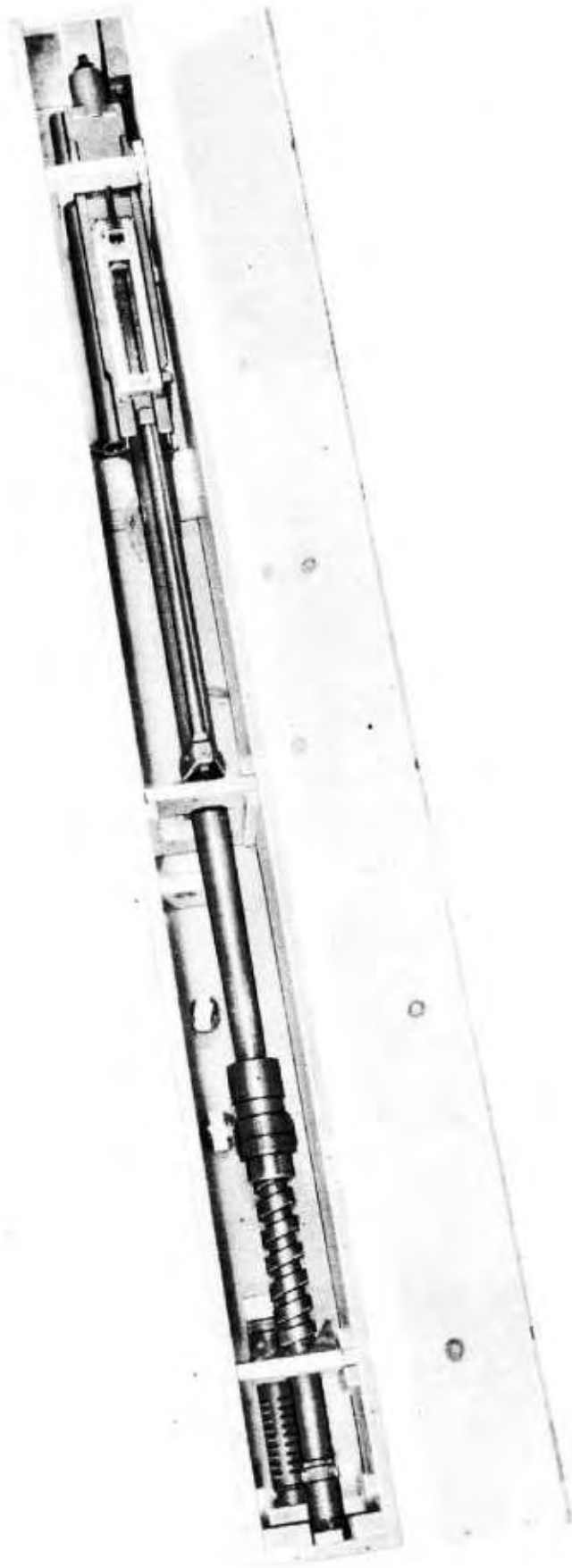

RA PD 68802

Figure 101 — Method of Packing a 20-MM Gun

20-MM AUTOMATIC GUN M1 AND
20-MM AIRCRAFT AUTOMATIC GUN AN-M2

Section XI

MAINTENANCE UNDER UNUSUAL CONDITIONS

	Paragraph
General	61
Care in arctic climates.....	62
Care in tropical climates.....	63

61. GENERAL.

a. When operating under unusual conditions such as tropical or arctic climates, severe dust or sand conditions, and near salt water, the precautions listed below should be scrupulously observed.

62. CARE IN ARCTIC CLIMATES.

a. In temperatures below freezing, and particularly in arctic climates, it is essential that all moving parts be kept absolutely free of moisture. It has also been found that excess oil on the working parts will solidify to such an extent as to cause sluggish operation or even complete failure. Metal parts should be cleaned with SOLVENT, dry-cleaning, and oiled as prescribed in paragraph 31.

b. Immediately upon being brought indoors, the gun should be thoroughly oiled, using OIL, lubricating, preservative, special, because moisture condensing on the cold metal in a warm room will cause rusting. After the gun has reached room temperature it should be wiped free of condensed water vapor and oiled again.

(1) If the gun has been fired, it should be thoroughly cleaned and oiled. The bore may be swabbed out with an oiled patch and when the weapon reaches room temperature, thoroughly cleaned and oiled as prescribed in paragraph 34.

(2) Before firing, the gun should be cleaned and the oil removed as prescribed in paragraph 33. The bore and chamber should be entirely free of oil before firing.

MAINTENANCE UNDER UNUSUAL CONDITIONS**63. CARE IN TROPICAL CLIMATES.****a. Tropical Climates.**

(1) In tropical climates where temperature and humidity are high, or where salt air is present, and during rainy seasons, the gun should be thoroughly inspected at frequent intervals and kept lightly oiled when not in use. The groups should be removed at regular intervals and, if necessary, disassembled sufficiently to enable the drying and oiling of parts.

(2) Care should be exercised to see that unexposed parts and surfaces are kept clean and oiled.

(3) In hot climates, OIL, lubricating, preservative, special, should be used for lubrication.

b. Hot, Dry Climates.

(1) In hot, dry climates where sand and dust are apt to get into the mechanism and bore, the gun should be wiped clean daily or more often, if necessary. Groups should be removed and disassembled as far as necessary to facilitate thorough cleaning.

(2) Oiling and lubrication should be kept to a minimum, as oil will collect dust which will act as an abrasive on the working parts and foul the bore and chamber. OIL, lubricating, preservative, special, is best for lubrication where temperatures are high, and should be lightly applied only to the surfaces and working parts showing signs of wear.

(3) Perspiration from the hands is usually acid and causes rust. Metal parts should therefore be wiped dry frequently.

(4) In dusty climates the breech and muzzle should be kept covered.

20-MM AUTOMATIC GUN M1 AND
20-MM AIRCRAFT AUTOMATIC GUN AN-M2

Section XII

REFERENCES

	Paragraph
Standard nomenclature lists	64
Explanatory publications	65

64. STANDARD NOMENCLATURE LISTS.

- a. Ammunition, fixed and semifixed, all types for pack, light and medium field artillery including complete round data SNL R-1
- b. Cleaning, preserving and lubricating materials; recoil fluids, special oils, and miscellaneous related items SNL K-1
- c. Gun, automatic, 20-mm, M1 and AN-M2 (aircraft) SNL A-47
- d. Soldering, brazing and welding material, gases, and related items SNL K-2

Current Standard Nomenclature Lists are as tabulated here. An up-to-date list of SNL's is maintained as the "Ordnance Publications for Supply Index" OPSI

65. EXPLANATORY PUBLICATIONS.

- a. Air corps technical order T.O. 11-1-21
- b. Ammunition, general TM 9-1900
- c. **Army Regulations.**
 - Ordnance field service in time of peace..... AR 45-30
 - Range regulations for firing ammunition for training and target practice AR 750-10
- d. Bureau of Ordnance circular letter (Navy)..... V-3-43
- e. Chemical decontamination materials and equipment TM 3-220
- f. Cleaning, preserving, lubricating, and welding materials and similar items issued by the Ordnance Department TM 9-850
- g. Defense against chemical attack FM 21-40

INDEX

A	Page No.	Page No.
Accessories, list of.....	124-126	breechblock locking key..... 89
Adapter AN-M1, 20-mm		driving spring guide group.... 80-81
functioning	33-36	gas cylinder and sleeve group.. 86
installation	36-40	magazine slide group..... 83
Adapters		rear buffer group..... 81-82
functioning of 20-mm adapter		receiver slides
M6	40	86
inspection	112	sear block group..... 86-89
20-mm adapter AN-M1		Breechblock assembly
functioning	33-36	defects, illustration
installation	36-40	description and functioning.... 14-18
20-mm adapter M7 with muzzle		inspection
brake M1	40-44	111
20-mm adapter M7 with thread		Breechblock group, disassembly.. 82-83
protector	40	Breechblock locking key
Ammunition		description and functioning..... 18
authorized rounds	119-120	disassembly
care, handling and preservation.. 119		89
cartridges	120-122	Breechblock modification
classification	113	5
field report of accidents..... 123		C
fuzes	122	Care and preservation of ammu-
identification	115-117	nition
nomenclature	113	119
packing and marking	122-123	Chargers
preparation for firing	120	hydraulic charger M1
Ammunition lot number..... 115		functioning
Arctic climates, maintenance		installation
of materiel in	130	inspection
Assembly of		111-112
basic gun	90-94	manual charger M2
feed mechanism AN-M1,		functioning
20-mm	95-100	installation
magazine, 60-round, 20-mm, M1.. 100		53-55
Authorized rounds of ammu-		Classification of ammunition..... 113
nition	119-120	Cleaning and lubrication
B		care after firing..... 107
Basic gun		care prior to firing..... 106-107
assembly	90-94	cleaning guns received from
disassembly		storage
breechblock group	82-83	106
		gun for storage and shipment.... 127
		preparation for storage..... 108
		D
		Data on gun..... 7
		Description, functioning, and
		installation
		adapters
		33-44
		automatic gun
		2-5
		basic gun
		9-23

20-MM AUTOMATIC GUN M1 AND
20-MM AIRCRAFT AUTOMATIC GUN AN-M2

D—Cont'd	Page No.	Page No.
Description, functioning, and installation—Cont'd		disassembly 86
chargers	49-55	inspection 111
feed mechanisms	55-74	Gun, automatic, 20-mm
feed mechanism AN-M1, 20-mm	55-62	cleaning prior to storage..... 127
gun type designations.....	29-33	description
sear actuating mechanisms.....	44-47	2-3
Differences between M1 and AN-M2 guns	5-6	Gun type designation, guns used by Army Air Force, Navy, and British
Disassembly of		29-33
basic gun	80-89	
feed mechanism AN-M1, 20-mm	94-95	H
magazine, 60-round, 20-MM, M1	100	Hydraulic charger (See hydraulic charger M1 under Chargers)
Driving spring guide group		
description and functioning.....	23	I
disassembly	80-81	Identification of ammunition... 115-117
E		Inspection
Electric trigger AN-M1		adapters
description and functioning.....	44-47	chargers
installation	47	feed mechanisms
		gun
F		sear actuating mechanisms..... 112
Feed mechanism AN-M1, 20-mm		
assembly	95-100	L
disassembly	94-95	Lubrication (See Cleaning and lubrication)
functioning	62-65	
inspection	111	M
loading	70-74	Magazine, 60-round, 20-mm, M1
lubrication	107	assembly and disassembly..... 100
Field report of ammunition accidents	123	installation on gun..... 79
Functioning of the gun as a whole	23-29	loading
(See also Description, functioning, and installation)		74
G		Magazine slide group
Gas cylinder and sleeve group		description and functioning... 12-14
description and functioning.....	9	disassembly
		83
		inspection
		111
		Maintenance under unusual conditions
		arctic climates
		130
		tropical climates
		131

INDEX

M—Cont'd	Page No.	Page No.
Malfunctions and corrections		
gun failures		
to extract	104-105	
to feed	103-104	
to fire chambered round.....	104	
misfire	102-103	
Manual charger (See manual charger M2 <i>under</i> Chargers)		
Marking ammunition	115	
Models of guns used by Army and Navy	5	
Modifications of guns.....	5	
Mounting arrangements of 20-mm AN-M1 adapter on naval instal- lation	38	
Muzzle velocity	7	
O		
Operation of gun		
feed mechanism AN-M1, 20-mm		
installation on gun.....	75-77	
unloading the gun.....	78-79	
firing the gun.....	77-78	
installation of magazine slide.....	75	
magazine, 60-round, 20-mm, M1, installation on and unloading the gun	79	
Organizational spare parts and accessories	124-126	
P		
Precautions in working with gun....	7-8	
R		
Rate of fire.....	2	
Rear buffer assembly		
description and functioning.....	19-23	
disassembly	81-82	
Receiver assembly, description and functioning	9-12	
Receiver slides, disassembly.....	86	
S		
Sear actuating mechanisms		
electric trigger AN-M1.....	44-47	
installation	47	
inspection	112	
sear mechanism M1.....	47	
Sear block group		
description and functioning....	18-19	
disassembly	86-89	
Sear mechanism M1, description and functioning	47	
Storage and shipment		
packaging	128	
preparation of materiel for.....	127	
removal of preservatives.....	128	
T		
Tools for assembly and disassembly of gun	124-126	
Tropical climates, maintenance of materiel in	131	
U		
Unloading the gun	78-79	
Unusual conditions, operation of materiel under	130-131	
W		
Weights of gun components.....	7	

TM 9-227

20-MM AUTOMATIC GUN M1 AND
20-MM AIRCRAFT AUTOMATIC GUN AN-M2

[A.G. 300.7 (6 May 1943)
O.O. 461/4283 O.O. (14 June 1943)]

BY ORDER OF THE SECRETARY OF WAR:

G. C. MARSHALL,
Chief of Staff.

OFFICIAL:

J. A. ULIO,
Major General,
The Adjutant General.

DISTRIBUTION: IB 1(2); IR 1(2); R 9(4); IBn 1(5); Bn 9(2);
IC 1(2); C 9(8)

(For explanation of symbols, see FM 21-6)

