

# 7.2-INCH MULTIPLE ROCKET LAUNCHER M17



WAR DEPARTMENT

• 9 JANUARY 1945

---

**RESTRICTED DISSEMINATION OF RESTRICTED MATTER—**  
No person is entitled solely by virtue of his grade or position to knowledge or possession of classified matter. Such matter is entrusted only to those individuals whose official duties require such knowledge or possession. (See also paragraph 23*b*, AR 380-5, 15 March 1944.)

---

WAR DEPARTMENT

Washington 25, D. C., 9 January 1945

TM 9-396, 7.2-inch Multiple Rocket Launcher M17, is published for the information and guidance of all concerned.

[ A.G. 300.7 (4 Jan 45)  
O.O. 300.5/7318 ]

BY ORDER OF THE SECRETARY OF WAR:

G. C. MARSHALL,  
*Chief of Staff.*

OFFICIAL:

J. A. ULIO,  
*Major General,*  
*The Adjutant General.*

DISTRIBUTION: AGF (5); ASF (2); T of Opns (10); S Div ASF (1); PE, 9 (5); Dist O, 9 (5); Dist Br O, 9 (3); Reg O, 9 (3); Decentralized Sub-O, 9 (3); A (10); CHQ (10); D (10).

(For explanation of symbols, see FM 21-6.)

# CONTENTS

---

| SECTION     |                                      | Paragraphs | Pages |
|-------------|--------------------------------------|------------|-------|
|             | I. Introduction .....                | 1- 3       | 1- 2  |
|             | II. Description and functioning..... | 4- 5       | 3-19  |
|             | III. Operation .....                 | 6-10       | 19-23 |
|             | IV. Ammunition .....                 | 11-17      | 23-29 |
|             | V. Care and maintenance.....         | 18-19      | 29-31 |
|             | VI. Installation of launcher.....    | 20-22      | 31-56 |
|             | VII. References .....                | 23-25      | 57-58 |
| INDEX ..... |                                      |            | 59    |

7.2-INCH MULTIPLE ROCKET LAUNCHER M17

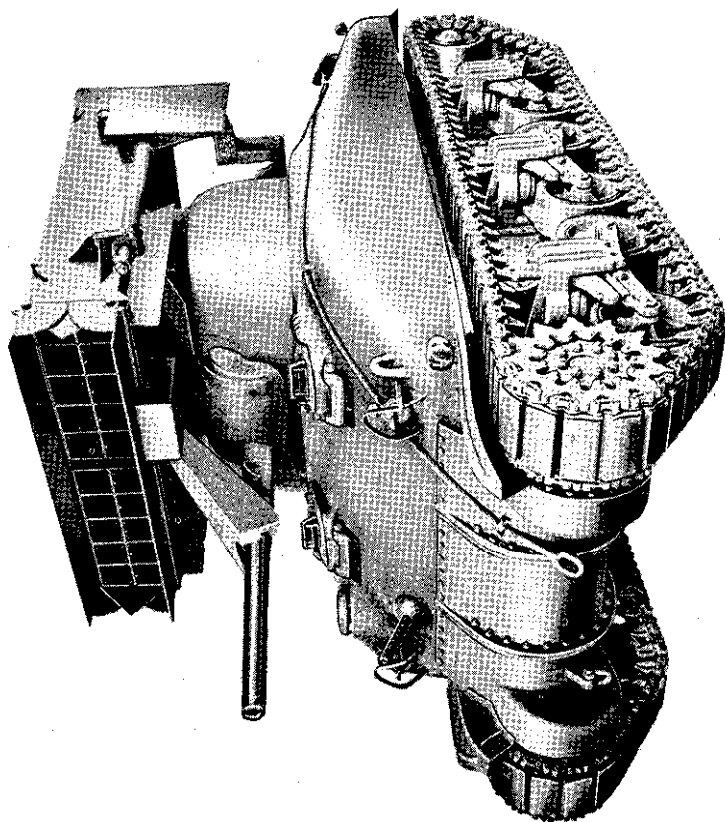

RA PD 90717

Figure 1—7.2-inch Multiple Rocket Launcher M17 Mounted on Medium Tank—Front Left View

**RESTRICTED**

**Section I**

**INTRODUCTION**

**1. SCOPE.\***

a. This Technical Manual is published for the information and guidance of personnel concerned with the operation and care of the 7.2-inch Multiple Rocket Launcher M17. It also contains information required to identify and handle the rockets used with this launcher and, in addition, information for the installation of the launcher, which must be performed by ordnance personnel.

**2. CHARACTERISTICS (figs. 1 and 2).**

a. The 7.2-inch Multiple Rocket Launcher M17 is designed to be mounted on the Medium Tanks M4, M4A1, M4A2, M4A3, M4A4, and M4A6. It has a capacity of 20 rockets which can be fired electrically either in single or automatic fire. The launcher is controlled in azimuth and elevation with the same controls as those used for the 75-mm gun mounted in the tank turret. It can be jettisoned by the tank crew by means of hydraulic controls operated from within the turret of the tank.

**3. DATA.**

|  |                                |
|--|--------------------------------|
| Weight of empty launcher.....                    | 4,615 lb                       |
| Length of launcher.....                          | 105 in.                        |
| Width of launcher.....                           | 105 in.                        |
| Limits of elevation:                             |                                |
| Maximum .....                                    | +25 deg                        |
| Depression .....                                 | -5 deg                         |
| Limits of traverse in degrees right or left..... | 360 deg                        |
| Rocket, HE, T37                                  |                                |
| Weight .....                                     | 61 lb                          |
| Length .....                                     | 35 in.                         |
| Maximum velocity .....                           | 160 ft per sec                 |
| Maximum range .....                              | 230 yd                         |
| Rocket, chemical, T21                            |                                |
| Weight .....                                     | 51.8 lb                        |
| Length .....                                     | 50 in.                         |
| Maximum velocity .....                           | 680 ft per sec                 |
| Maximum range .....                              | 3,430 yd (at 43-deg elevation) |

\*To provide operating instructions with the materiel, this Technical Manual has been published in advance of complete technical review. Any errors or omissions will be corrected by changes or, if extensive, by an early revision.

7.2-INCH MULTIPLE ROCKET LAUNCHER M17

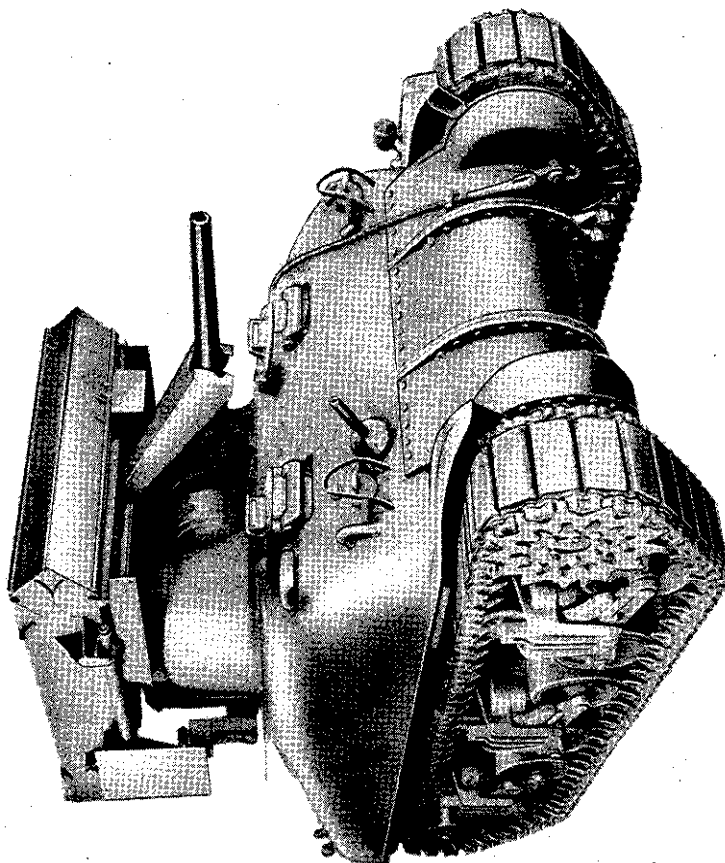

RA PD 90718  
Figure 2—7.2-inch Multiple Rocket Launcher M17 Mounted on Medium Tank—Front Right View

## Section II

**DESCRIPTION AND FUNCTIONING****4. DESCRIPTION.**

a. **General.** The principal components of the materiel are as follows:

- (1) Launcher rail assembly.
- (2) Tank attachments.
- (3) Trunnion supports.
- (4) Elevating strut.
- (5) Equipment for operating the launcher doors.
- (6) Quadrant assembly.
- (7) Firing mechanism.
- (8) Equipment for jettisoning the launcher.

b. **Launcher Rail Assembly (figs. 3 to 8).**

(1) The launcher rail assembly consists principally of 20 rails, in two layers of 10 each, from which the rockets are fired. The rails are of sheet steel and 90 inches long. The bottom and sides of the rail assembly are protected by armor plate. On each side there are two hooks, one near each upper corner, by means of which the launcher rail assembly can be lifted for installation, removal, and repair (figs. 3 and 4).

(2) On each side of the rail assembly, near the rear end, there is a trunnion on which the launcher rotates in elevation (figs. 3 and 4). On each side toward the front there is a bracket to which one end of the equilibrator spring assembly is secured (figs. 3 and 4). The other end of equilibrator spring is secured by wire to the trunnion (when not assembled) and latched to the trunnion support (when assembled). The function of the equilibrator spring assembly is to neutralize the unbalanced weight of the launcher and to reduce the effort required to elevate it.

(3) At the rear of each rail, there is a spring-operated tail latch and two electrical contactors (fig. 5). When the rockets are properly loaded in the launcher, the tail latch engages the stabilizer ring of the rocket and prevents the rocket from sliding before being fired. The contactors of the rail establish contact with the stabilizer rings of the rocket to which the leads of rocket motor igniter are connected, and thus serves to complete the circuit for firing. The forward or ground contactor actuates a microswitch (when rocket is loaded in position) to complete a circuit to the indicator light bulbs on the front of firing mechanism box. Thus, it is possible to tell which rails are loaded and which are empty. The indicator switches and electrical connections are protected by two armor plate covers; the covers can be opened for inspection and repair (fig. 6).

7.2-INCH MULTIPLE ROCKET LAUNCHER M17

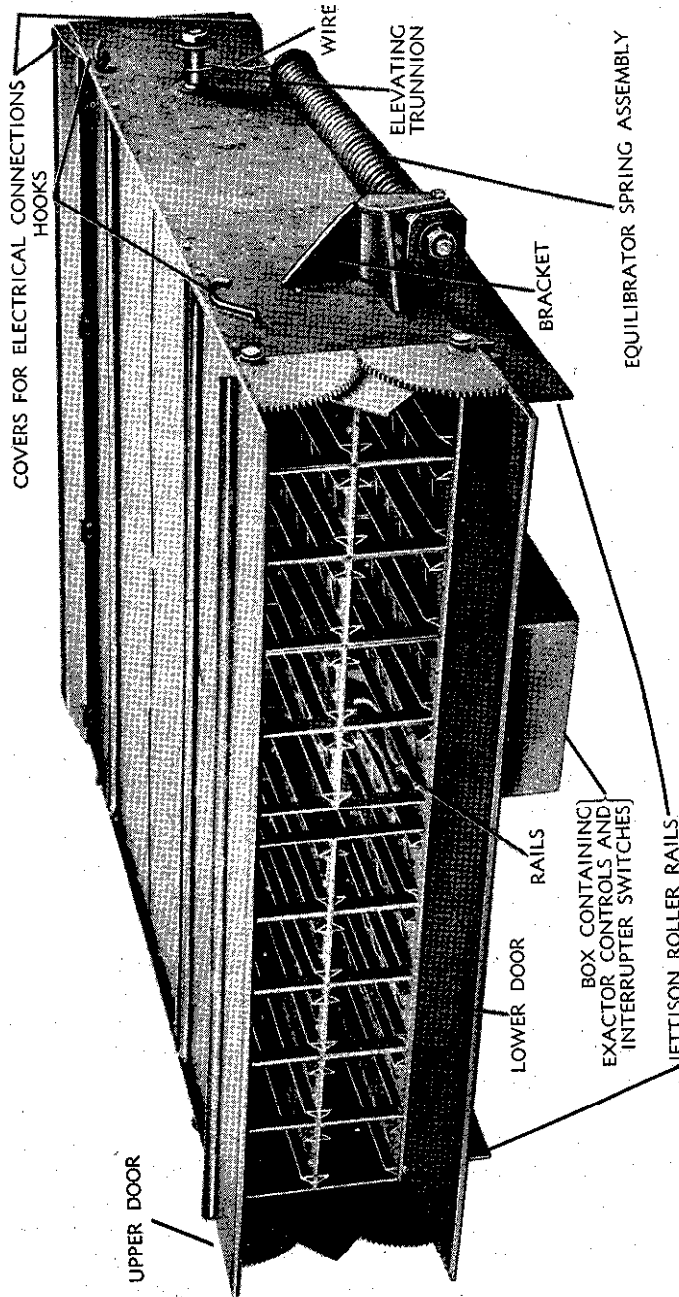

RA PD 90719

Figure 3—Launcher Rail Assembly—Front Left View



DESCRIPTION AND FUNCTIONING

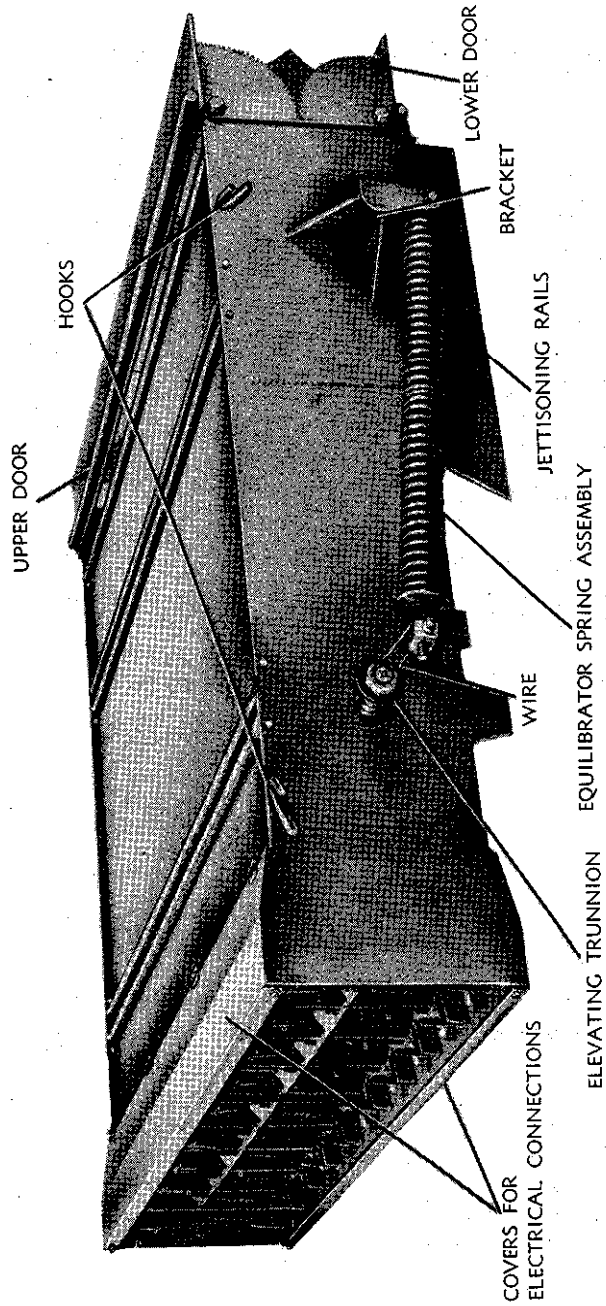

RA PD 90720

Figure 4—Launcher Rail Assembly—Rear Right View

## 7.2-INCH MULTIPLE ROCKET LAUNCHER M17

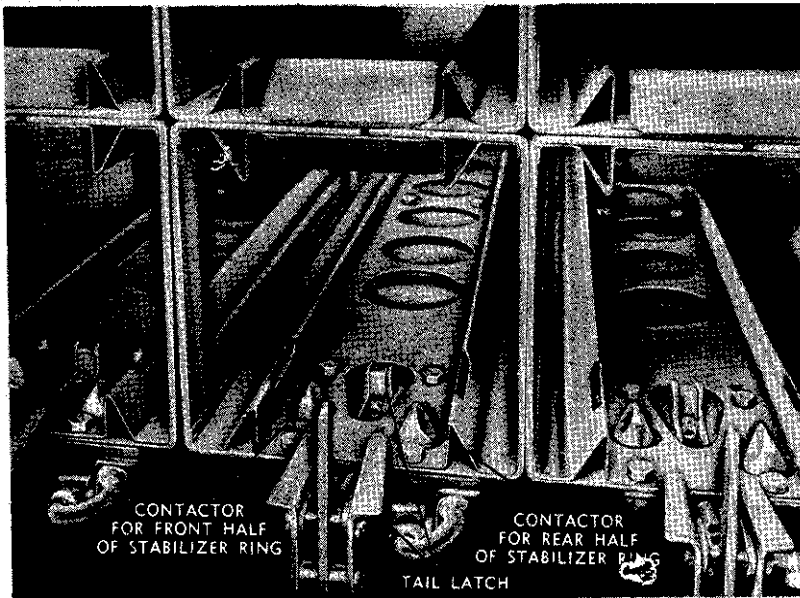

RA PD 90721

**Figure 5—Tail Latch and Contactors**

(4) The front of the rail assembly is protected by two armor plate doors hinged on top and bottom (figs. 3 and 4). The doors are geared together at their ends so that they open and close together. The doors are operated by an exactor control transmitter mounted in the tank turret and two exactor control receivers mounted on the under side of the lower door toward the left (fig. 7). Near the exactor control receivers are two interrupter switches (fig. 7). The exactor control receivers and switches are protected by an armor plate cover (fig. 7).

(5) Behind the box for the exactors and switches is a hinged armor plate which serves to protect the hydraulic and electrical cables leading from the launcher into the tank turret.

(6) On the under side of the rail assembly, toward the front, is a threaded block into which is screwed in one end of the elevating strut (fig. 8); the other end of the strut is latched to the gun shield adapter so that the gun and launcher are elevated together.

(7) The two plates on the under side of the rail assembly, near the sides, serve as rails for the jettisoning rollers on the tank turret when the launcher is jettisoned.

c. **Tank Attachments.** The components described below are

## DESCRIPTION AND FUNCTIONING

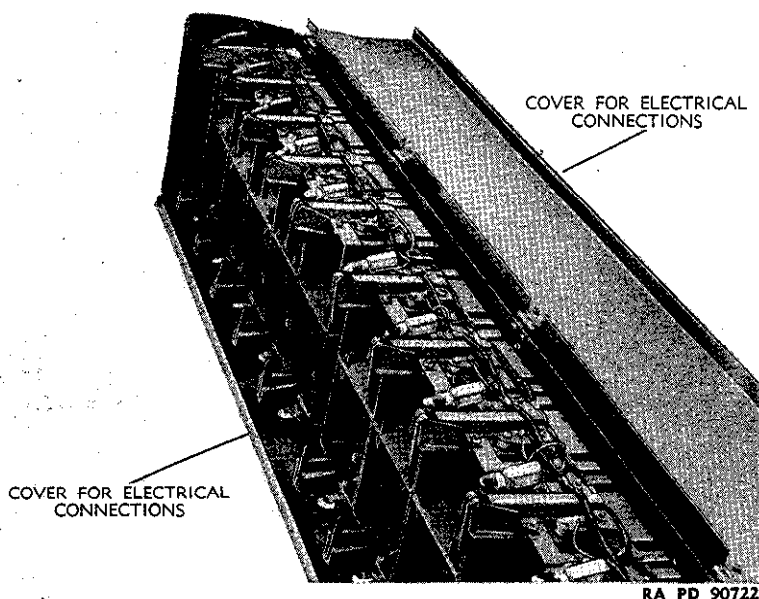

**Figure 6—Microswitches and Electrical Connections on Launcher Rail Assembly**

welded to the tank and serve to secure the launcher rail assembly to the tank, and to elevate and to jettison the launcher.

(1) **GUN SHIELD ADAPTER** (fig. 9). This adapter fits around the gun tube and is welded to the gun shield. It has two trunnions, one on each side, to which the lower end of the elevating strut is latched.

(2) **TRUNNION PIN BRACKETS** (fig. 10). There are two trunnion pin brackets welded to the tank, one on each side of the turret. Each bracket has a cylindrical surface at the outer end which serves as a bearing for the trunnion support by means of which the launcher is supported on the tank.

(3) **TRUNNION LATCH PLATES** (fig. 10). There are two latch plates welded to the tank, one on each side of the turret above the trunnion pin brackets. Each latch plate has a fixed pin and a hinged pin at its outer end. The hinged pin is connected to the lower jettisoning latch on the trunnion support by means of which the support can be disengaged from the latch plate for jettisoning. The fixed pin bears against a projection on the front edge of the trunnion support and prevents the trunnion support from lifting off the trunnion pin bracket except when launcher is to be jettisoned.

7.2-INCH MULTIPLE ROCKET LAUNCHER M17

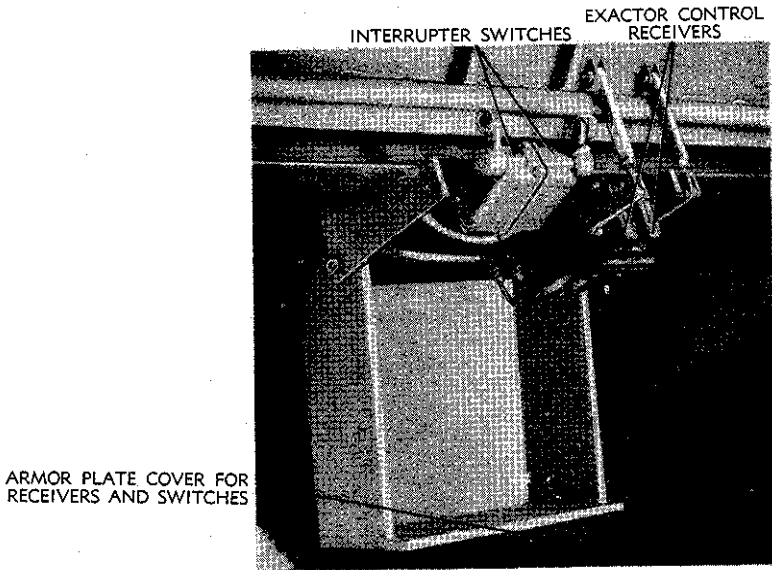

RA PD 90727

**Figure 7—Exactor Control Receivers and Interrupter Switches for Doors**

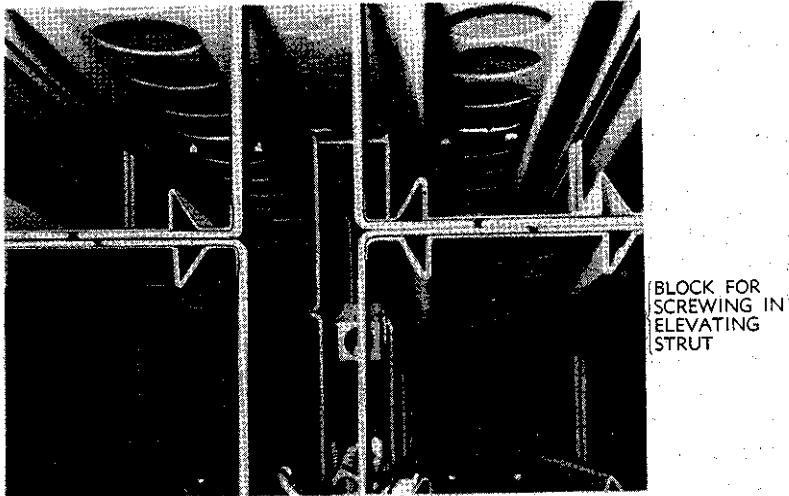

RA PD 90743

**Figure 8—Block for Securing Elevating Strut to Launcher Rail Assembly**

## DESCRIPTION AND FUNCTIONING

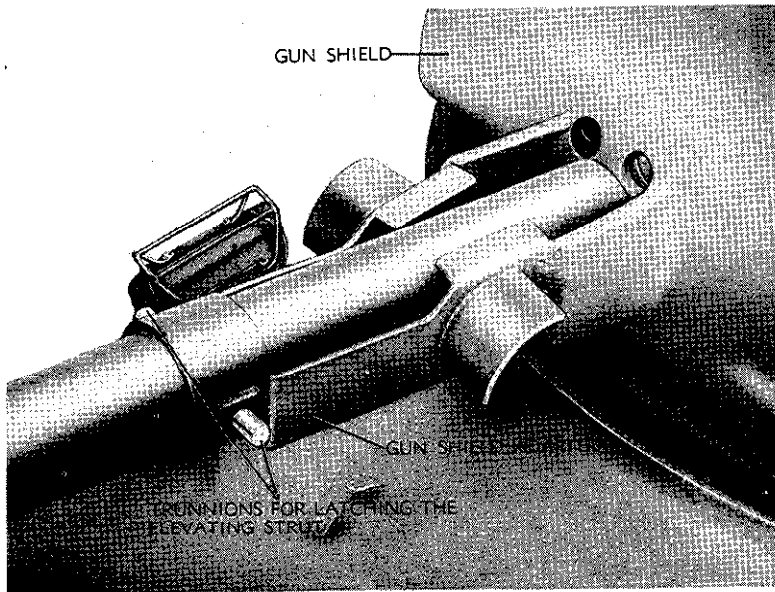

RA PD 90723

**Figure 9—Gun Shield Adapter Welded to Gun Shield**

(4) **JETTISON ROLLER BRACKETS** (fig. 10). Each of these two brackets is welded to the top side of the turret. Each carries a jettisoning roller on which the launcher rides when being jettisoned.

**d. Trunnion Supports** (fig. 11).

(1) The two trunnion supports are the means for attaching the launcher rail assembly to the tank turret. Each support is about 3 feet long and is made with an offset, because the launcher is wider than the tank turret.

(2) At the upper end of each trunnion support is the bearing for the elevating trunnion. It is about this trunnion that the launcher assembly rotates in elevation.

(3) At the lower end of each trunnion support is the bearing for the trunnion pin bracket which is welded to the tank turret. This bearing is semicircular, so that it may pull away from the trunnion pin bracket when jettisoning takes place.

(4) On the front edge of each trunnion support, slightly above the offset, a small rectangular piece of steel is welded. This projection bears on the under side of the fixed pin of the latch plate, and prevents the trunnion support from lifting off the trunnion pin brackets, except when it is desired to jettison the launcher.

## 7.2-INCH MULTIPLE ROCKET LAUNCHER M17

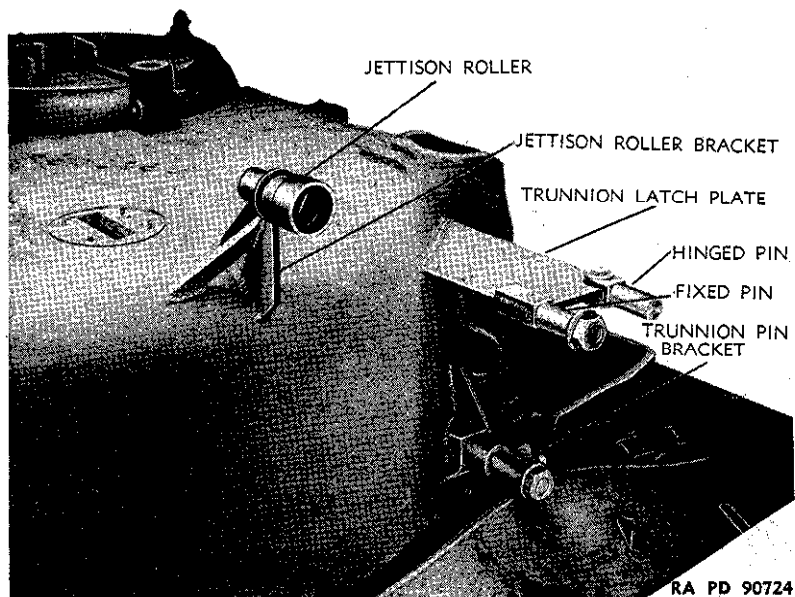
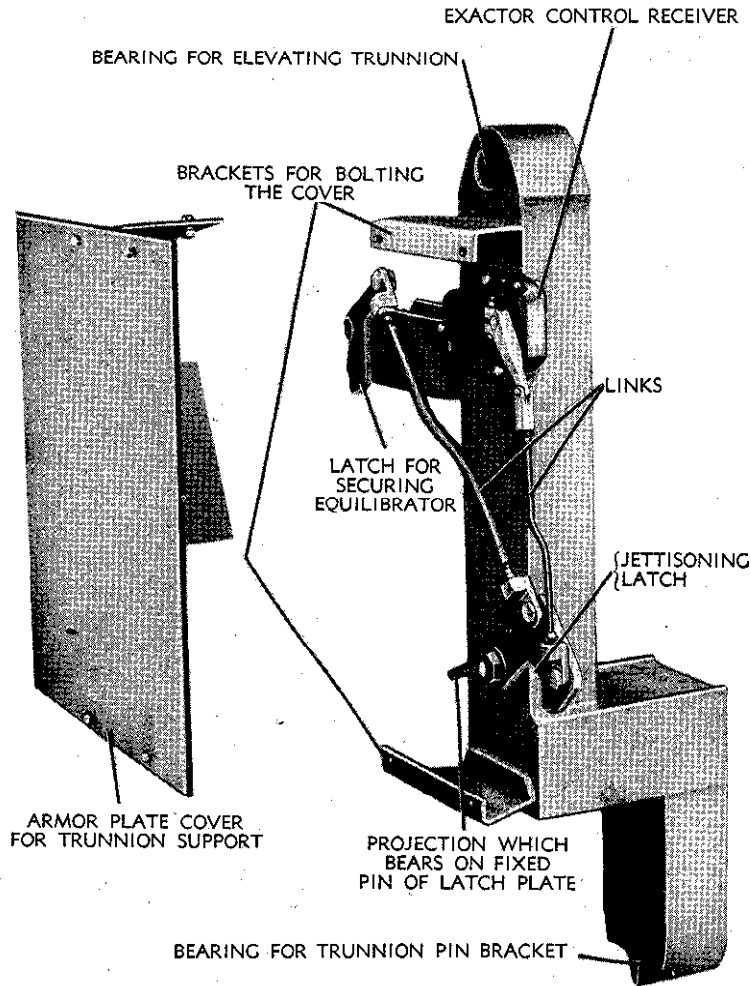

**Figure 10—Brackets and Plates Welded to Turret**

(5) Somewhat above these projections there is a clevis construction with latches extending forward from the front side of each trunnion support. These are for securing the crossheads at the rear ends of the equilibrator spring assemblies. The equilibrator spring latches are connected by links to the upper jettisoning latches. A lower jettisoning latch is located on the outside of each trunnion support toward the rear edge and is so positioned as to hook over the hinged pin of the corresponding latch plate. The jettisoning latches are connected to the exactor control receivers mounted slightly above them by means of links. The linkage and the exactor control receivers are so arranged that when the exactor control receivers are actuated, they operate the jettisoning latches, thereby releasing the trunnion supports from the trunnion pin brackets and the latch plates. An armor plate cover is bolted to each trunnion support in order to protect the exactor control receivers, latches, and linkage.

e. **Elevating Strut** (fig. 12). The elevating strut connects the forward end of the launcher assembly with the gun shield adapter. On the lower end of the elevating strut is a clevis construction with latches which engage the two trunnions of the adapter. These latches are actuated by an exactor control receiver mounted about halfway up the elevating strut. This exactor control receiver operates simul-

## DESCRIPTION AND FUNCTIONING



RA PD 90725

**Figure 11—Trunnion Support and Cover**

taneously with the two on the trunnion supports and is the means of disconnecting the elevating strut from the trunnion adapter when jettisoning takes place. The upper end of the elevating strut is provided with the screw fitting which is used to adjust the launcher assembly so it will be parallel with the gun tube. The exactor control receiver, linkage, and latches of the elevating strut are protected by an armor plate cover.

7.2-INCH MULTIPLE ROCKET LAUNCHER M17

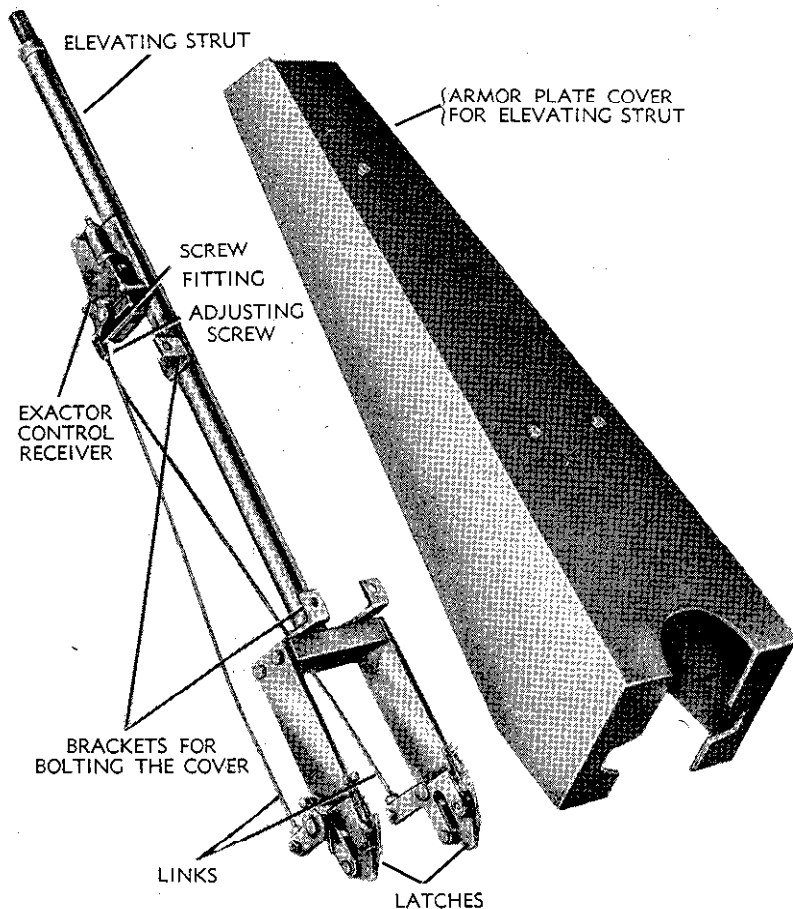

RA PD 90726

**Figure 12—Elevating Strut and Cover**

**f. Equipment for Operating the Launcher Doors (figs. 7 and 13).**

(1) The doors are operated by two exactor control hydraulic transmitters (fig. 13) mounted as a single unit in the tank turret, and two exactor control hydraulic receivers mounted on the underside of the lower door (fig. 7). The connection from the two transmitters to the two receivers is by a single hydraulic line. This line passes through a periscope block equipped with disconnect fittings which can be separated quickly when the launcher is jettisoned.

(2) To the left of the exactor control receivers are two inter-



DESCRIPTION AND FUNCTIONING

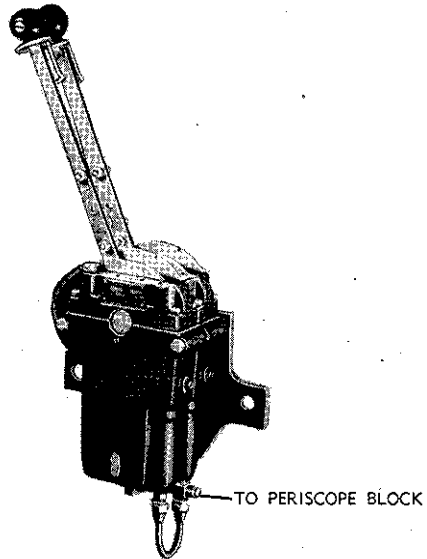

RA PD 90728

Figure 13—Exactor Control Transmitters for Doors

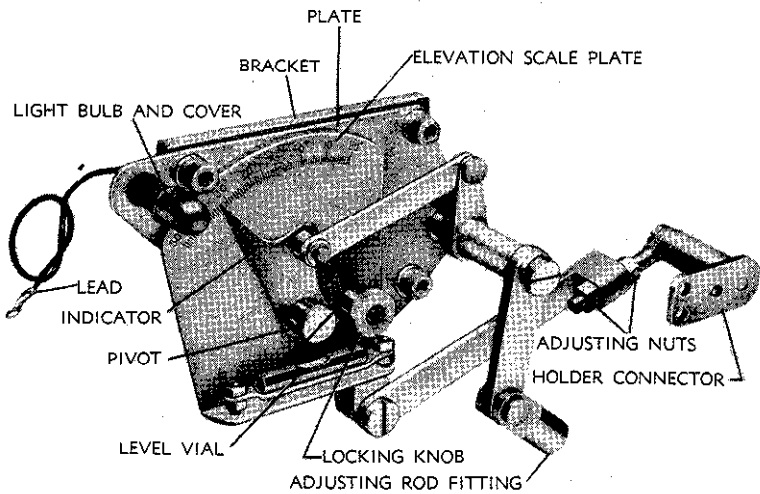

RA PD 90729

Figure 14—Quadrant Assembly

## 7.2-INCH MULTIPLE ROCKET LAUNCHER M17

rupter switches (fig. 7). These switches are operated by the closing action of the lower door. The function of these switches is to interrupt the firing circuit when the doors are not open.

**g. Quadrant (fig. 14).**

(1) The quadrant is installed in the tank turret and is used to aim the launcher in elevation. The bracket is welded to the ceiling of the tank turret and the plate of the quadrant is attached to the bracket by three Allen-type screws.

(2) The elevation scale plate is provided with a level vial. The elevation scale is graduated in degrees from zero to +50, and from zero to -20, with every 10 degrees marked. The scale plate is illuminated by a light bulb. The lead from the light bulb is spliced to the lead of the dome light bulb on the left side of the 75-mm gun.

(3) The elevation plate is linked to the periscope by means of a link and holder connector so that, as the periscope is tilted, the elevation scale plate rotates on its pivot. In this manner it is possible to tilt the periscope until the vial bubble is centered. The elevation scale plate can then be locked in position by means of the locking knob.

(4) The elevation indicator is connected by linkage to the adjusting rod of the gun elevating mechanism. By elevating the gun (and launcher) the linkage will move the indicator to the desired elevation reading on the plate.

**h. Firing Mechanism (figs. 15 and 16).**

(1) The firing mechanism for launching the rockets is mounted in the tank turret and operates on a 24-volt source from the tank batteries. The mechanism is housed in a steel case having two brackets on each side for attaching it to the turret wall.

(2) The mechanism has an indicator circuit consisting of 20 light bulbs positioned on a dial face over numbers corresponding to the 20-conductor points. These bulbs are operated by a circuit to the launcher. The circular selective switch for the 20 individual conductor points is provided with a knob which can be turned *only clockwise* to any individual conductor. When a rocket is properly loaded in a launcher rail, the corresponding indicator light bulb will be illuminated. When the launcher rail is not loaded, the corresponding indicator light bulb will not be illuminated.

(3) On the top of the left side of the box there is a receptacle for the safety plug. Attached to the safety plug is a loading diagram tag to record the type of rocket on each launcher rail. **NOTE: The safety plug must be removed from the box and kept in the personal possession of gunner until ready to fire.**

(4) On the middle of the left side of the box there is a receptacle for the firing cable. The firing cable leads from the box to the launcher

## DESCRIPTION AND FUNCTIONING

rail assembly by way of the periscope block; this is for ease in disconnecting when the launcher is to be jettisoned.

(5) On the bottom of the left side of the box, there is a receptacle for the firing cable with the trigger mechanism for firing the rockets.

(6) On the middle of the right side of the box there is a receptacle for the indicator light cable. The indicator light cable leads from the box to the launcher rail assembly by way of the periscope block; this is for ease in disconnecting when the launcher is to be jettisoned.

(7) On the bottom of the right side of the box there is a receptacle for the 24-volt battery lead which has a 20-ampere fuse in the line cord.

(8) The two light bulbs on lower front of box toward the right, under the marking "BATTERY PILOT," indicate battery current when they are illuminated.

(9) The two light bulbs on lower front of box toward the left, under the marking "FIRING PILOT," will be illuminated to indicate firing current when the safety plug is in place and launcher doors are open.

(10) The selector switch located below the "BATTERY PILOT" light bulbs can be set either at "SELECTIVE" or "AUTOMATIC." With the switch set at "SELECTIVE," pressing of the trigger will fire the rocket corresponding to the number at which the indicator is set on the dial face. By resetting the indicator to another selection on the dial face, another rocket can be fired. With the switch set at "AUTOMATIC," pressing of the trigger will fire the rockets automatically. Firing will continue as long as the trigger is pressed or until the rockets are used up. The rate of automatic firing can be adjusted by turning the timing knob located below the "FIRING PILOT" light bulbs. Turning of the timing knob sets a rheostat in the box. It is possible to regulate the time interval between successive firing of the rockets from less than one-half second to more than 2 seconds.

### i. Equipment for Jettisoning (figs. 17 and 18).

(1) The equipment for jettisoning the launcher consists of the exactor control transmitter, periscope block, and exactor control receivers with linkage on the trunnion supports and on the elevating strut.

(2) **EXACTOR CONTROL TRANSMITTER** (fig. 17). The transmitter serves a double purpose—it is used to fill the receivers and to actuate the receivers and linkage to jettison the launcher. The transmitter consists of three separate units—one for the receiver on the elevating strut and one each for the trunnion supports. The hydraulic line from each unit is connected to its respective receiver by way of the periscope; this is for ease in disconnecting when the launcher is to be jettisoned.

7.2-INCH MULTIPLE ROCKET LAUNCHER M17

RA PD 90730

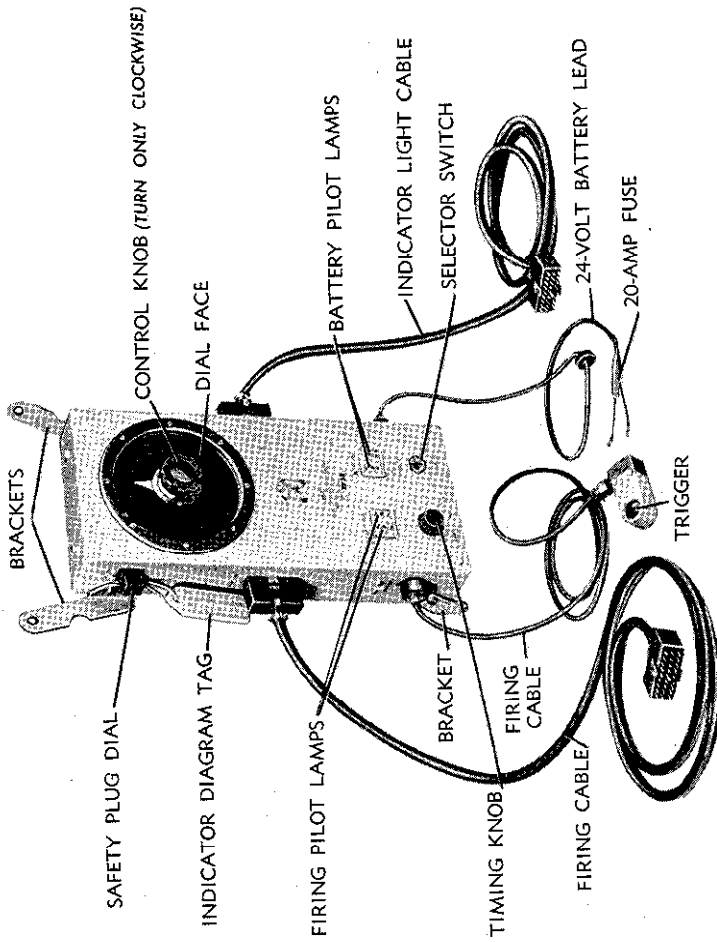

Figure 15—Firing Mechanism—Left Front View

DESCRIPTION AND FUNCTIONING

RA PD 90731

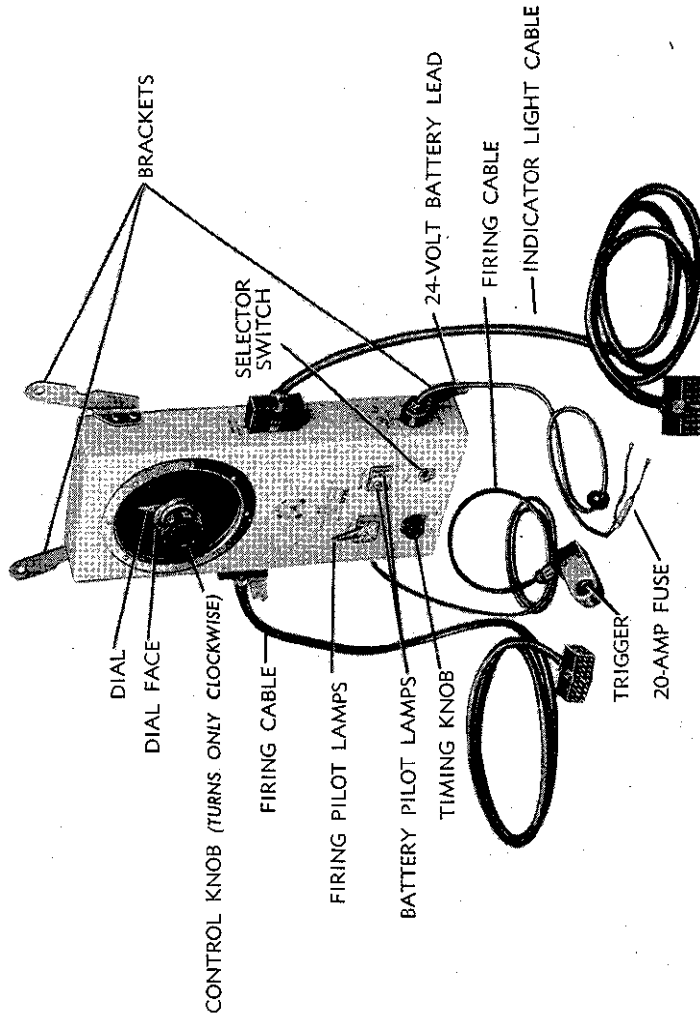
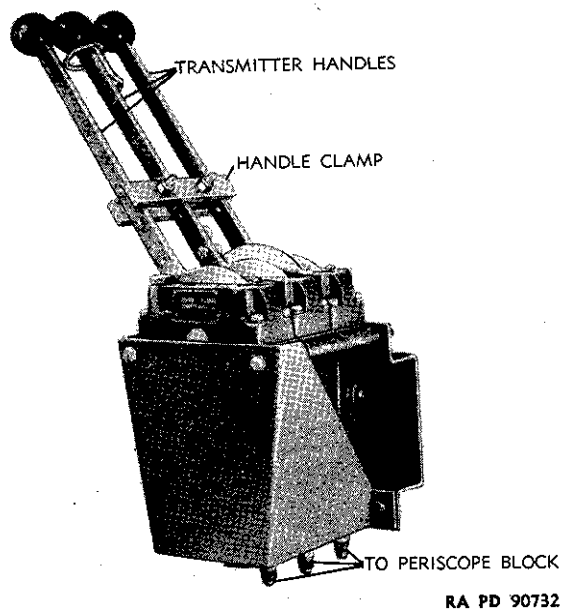

Figure 16—Firing Mechanism—Right Front View

## 7.2-INCH MULTIPLE ROCKET LAUNCHER M17



**Figure 17—Exactor Control Transmitters for Jettisoning**

(3) **PERISCOPE BLOCK** (fig. 18). The periscope block is a device which makes it possible to separate quickly the firing cables and hydraulic lines when the launcher is jettisoned. It consists of two jettison guides connected at their ends to two blocks. Both the top split block (wood) and the lower block (metal) are grooved to accommodate the nipples and disconnect fittings. The hydraulic lines from the transmitter are connected to the lower ends of the disconnect fittings; the hydraulic lines from the receivers are connected to the upper ends of the nipples. The firing cable and indicator light cable from the launcher enter the jettison guides from the top; the firing cable and indicator light cable from the firing mechanism are joined to the jettison guides by means of receptacles on the sides. The lower part of the periscope block is positioned inside the tank and the upper part outside the tank. The upper part is connected to the launcher by a chain so that it will be pulled out when the launcher is jettisoned.

(4) **EXACTOR CONTROL RECEIVERS** (figs. 11 and 12). An exactor control receiver is mounted on the elevating strut and on each of the supporting trunnions. The receivers are connected to the jettisoning latches by means of links. The linkage and receivers on the trunnion supports are so arranged that when the receivers are actuated by the transmitters in the tank turret, they operate the jettisoning latches,

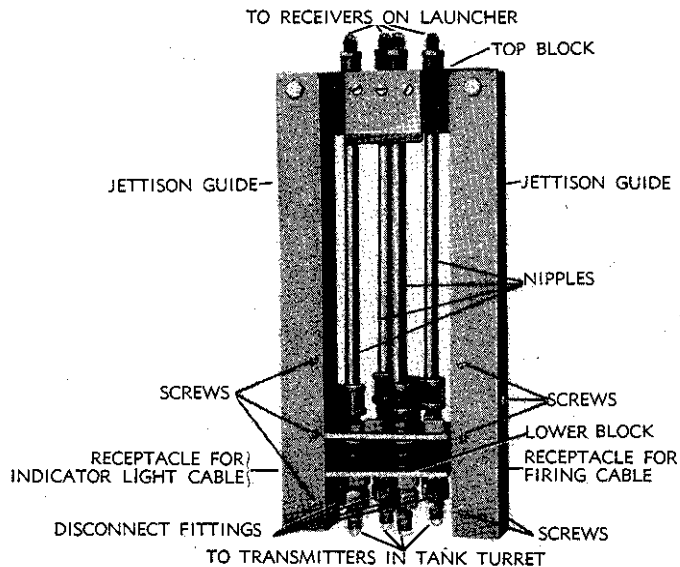
**OPERATION**

RA PD 90733

**Figure 18—Periscope Block**

thereby releasing the trunnion supports from the trunnion pin brackets and the latch plates. Simultaneously, the jettisoning latches on the elevating strut release the strut from the gun shield adapter.

**5. FUNCTIONING.**

a. When the trigger of the firing cable is pressed, it completes the firing circuit so that an electric current can pass through the rocket.

b. The passage of the electric current through the rocker sets off the rocket motor igniter which in turn ignites the propelling charge. The rearward escape of the powder gases through a jet forces the rocket out of the launcher. Propulsion of the rocket is by jet action of the propellant powder and hence there is no recoil.

---

**Section III**  
**OPERATION**

**6. LOADING.**

**CAUTION:** Before proceeding to load, remove the safety plug from the firing mechanism box. Safety plug must be kept in per-

**7.2-INCH MULTIPLE ROCKET LAUNCHER M17**

sonal possession of gunner and is to be inserted into box only when ready to fire.

a. Slide the assembled rocket head first, into the breech of launcher rail (fig. 19) until the tail is engaged by the tail latch (fig. 20).

b. Record the types of rockets loaded and, the corresponding launcher rail numbers on the loading diagram tag.

c. The two "BATTERY PILOT" light bulbs will indicate battery current.

d. The light bulbs on the dial face will indicate the rockets in launcher rails. If a rocket is on a launcher rail and the corresponding indicator light bulb does not illuminate, it may be due to a defective light bulb or incorrect adjustment of indicator microswitch. Replace the bulb with one from the dial that does illuminate. If bulb illuminates, the previous bulb was defective and must be replaced. If bulb does not illuminate, the switch should be adjusted as described in paragraph 18.

**7. SIGHTING.****a. Indirect.**

(1) Manipulate the periscope holder until the bubble vial on the quadrant is level; clamp the elevation scale plate in this position.

(2) Elevate the gun and launcher until the indicator points to the desired angle of elevation on the plate.

**b. Direct.**

(1) Sight the target through periscope and bring target to desired point on reticle pattern.

(2) Elevate gun until indicator is at desired reading.

**8. FIRING.**

a. Open the launcher doors by pushing the two handles of transmitter forward a full stroke and latching in position.

b. Insert the safety plug into the firing mechanism box. The two "FIRING PILOT" light bulbs on the box will indicate firing current.

c. **Selective Firing.** For selective or single firing, set the indicator on dial face to rocket selected from tag, turn the selector switch to "SELECTIVE," and press the trigger to discharge the rocket.

**d. Automatic Firing.**

(1) For automatic firing, set the indicator on dial face to desired starting position, turn the selector switch to "AUTOMATIC," and



OPERATION

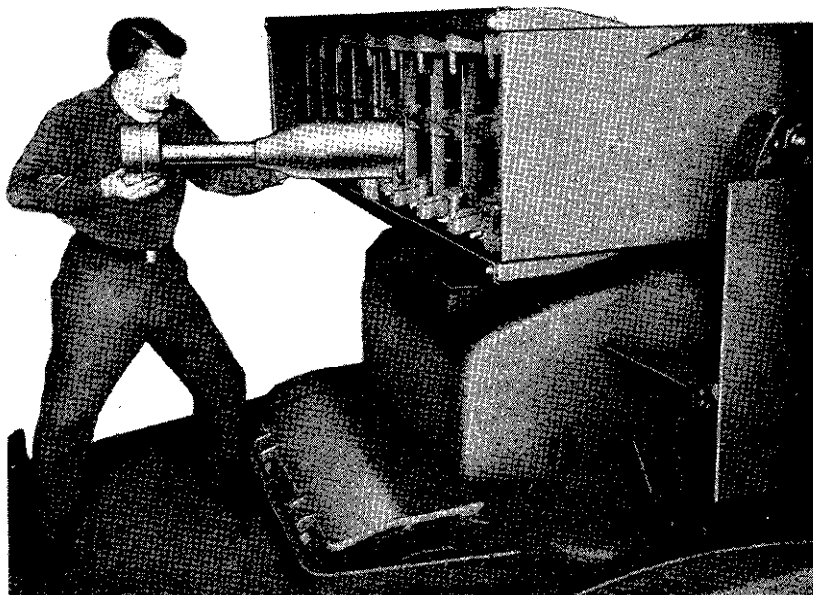

RA PD 90747

**Figure 19—Loading the Rockets Into Launcher**

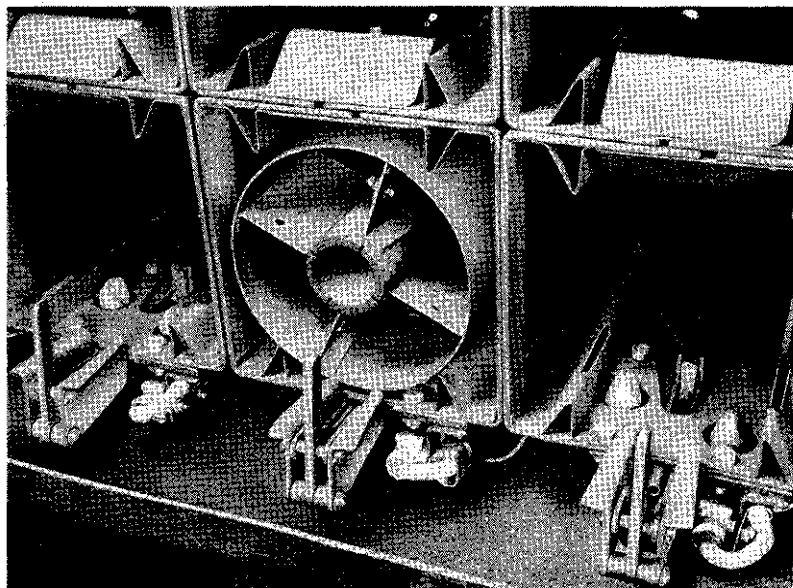

RA PD 90764

**Figure 20—Rocket Properly Loaded in Launcher**

## 7.2-INCH MULTIPLE ROCKET LAUNCHER M17

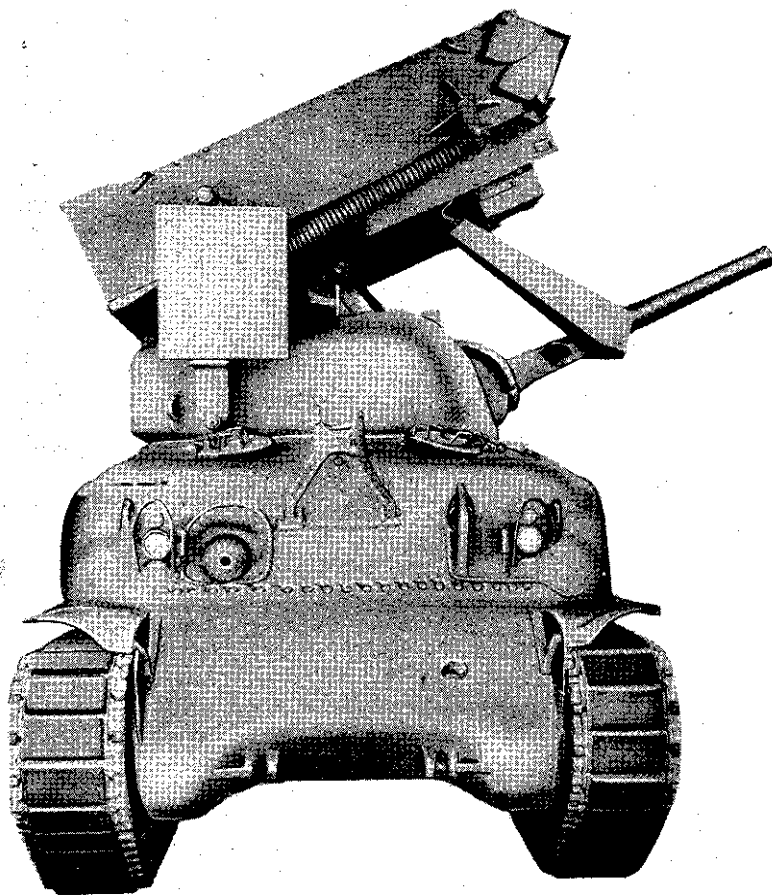

RA PD 90765

**Figure 21—Launcher in Position for Jettisoning**

press the trigger. Firing will continue as long as the trigger is pressed and there is ammunition in the launcher.

(2) The time interval between successive rounds can be varied from less than one-half second to more than 2 seconds by setting the timing knob.

(3) It is possible to fire single rounds by releasing the pressure on the trigger before the indicator has moved to the next number on the dial face.

**CAUTION:** As soon as firing ceases, remove safety plug from firing mechanism box.

**AMMUNITION****9. UNLOADING.**

**CAUTION:** *Make certain safety plug is removed from box before proceeding to unload.*

a. Press the tail latch lever forward to allow rocket to clear and remove rocket from launcher rail.

b. If rocket is not fired, disassemble, and return components to original condition and packings.

**10. JETTISONING.**

a. Rotate the turret 90 degrees until launcher is at right angles to direction of travel of tank.

b. Elevate the launcher 25 degrees or full range of elevating gear (fig. 21).

c. Disconnect the firing cable and indicator light cable from the periscope block in turret.

d. Remove cover from jettisoning transmitters and pull handles to rear.

---

**Section IV****AMMUNITION****11. GENERAL.**

a. **Classification.** Rockets for use with the 7.2-inch Launcher M17 are issued in the form of unassembled complete rounds. They are classified as high-explosive, chemical, and practice. The high-explosive rocket is intended for use against reinforced concrete obstruction and fortifications. The chemical rocket contains a chemical charge with a burster to open the shell and distribute the contents at the target. The practice rocket shell contains inert filler and dummy fuze, but is otherwise similar to the service round.

**b. Components.**

(1) **SHELL.** The rocket shell (figs. 22 and 23) is a pear-shaped casing of thin metal containing the charge. A fuze cavity in the nose (T21) or base (T37) opens into a well which receives the burster or booster. The rear end of the shell has a threaded attachment for assembling the motor. Base-fuzed shells are issued with the fuze and booster assembled. Nose-fuzed shells are issued with fuze and burster separate. In both cases, the fuze opening is protected by a shipping plug.

**7.2-INCH MULTIPLE ROCKET LAUNCHER M17**

(2) **MOTOR.** The rocket motor consists essentially of a cylindrical chamber closed at one end and constricted at the other to form a nozzle. It contains the propelling charge and an electric igniter. The motor body is a steel tube with threading at the front end for attachment to the shell, and with a fin assembly attached to the rear. The propelling charge consists of a cylindrical grain of rocket propellant with a single axial perforation. The igniter is assembled in the front end of the motor and consists of a container of black powder with an electric squib. The squib wires pass through the propellant and the nozzle, and are connected to the fin shrouds which serve as contacts for the launcher firing mechanism. The fin assembly consists of four radial vanes strengthened by two cylindrical shrouds. The rear shroud is grounded through the fin to the rocket body; the front shroud is electrically insulated and serves as the live igniter contact. Motors of various diameters are supplied with 7.2-inch rockets, dependent upon requirements for velocity, range, or other ballistic characteristics.

**12. COMPLETE ROUNDS.**

**a. Authorized Rounds.** The rounds authorized for use in this launcher are:

**ROCKET, HE, 7.2", T37, w/FUZE, rocket, BD, Mk. 146** (figs. 24 and 25)

**ROCKET, gas, CG, 7.2", T21, w/FUZE, rocket, PD, Mk. 147 and BURSTER** (figs. 48 and 52)

**ROCKET, practice, 7.2", T44 (E1)**

**b. Data.**

|                        | HE, T37           | Type and Model<br>Chemical, T21 (HE T24) |
|------------------------|-------------------|--|
| Length .....           | 35 in.            | 50 in.                                   |
| Weight .....           | 61 lb             | 51.8 lb                                  |
| Maximum velocity ..... | 160 ft per sec    | 680 ft per sec                           |
| Maximum range .....    | 230 yd            | 3430 (at 43-deg elev.) yd                |
| Motor .....            | 2.25", Mk. 3      | 3.25", Mk. 5, Mk. 7                      |
| Fuze .....             | BD, Mk. 146       | PD, Mk. 147, w/Burster                   |
| Shell charge .....     | Plastic HE, 32 lb | Gas CG, 20 lb                            |

**13. FUZE MK. 146.**

**a.** This fuze is the Navy Fuze Mk. 146. It is a base-detonating fuze which has been installed in the rear opening of the rocket shell before issue to troops. The fuze is protected during shipment of the ammunition by means of the shipping plug. There are no safety pins or wires to be removed from the fuze prior to loading the launcher. Arming of the fuze is accomplished in two stages: one stage is the

## AMMUNITION

pressure of the burning propellant which partially arms the fuze; the other stage is acceleration of the round in flight. When fully armed, a round will be detonated by a drop on its nose. **CAUTION:** *There is no way to determine whether or not a fuze has become armed due to ignition and resultant pressure of the propellant. Duds and those rounds which have had their propellant charges fired must be handled carefully because the fuze may be armed. Do not attempt to remove the fuze. Dispose of such ammunition in accordance with regulations for disposal and destruction of unserviceable ammunition.*

### 14. FUZE MK. 147.

a. **Description.** This fuze is the Navy Fuze Mk. 147 (fig. 26). It is a vane-arming, point-detonating fuze. In the unarmed condition, the detonator shutter is held out of firing position by the firing pin which is attached to the propeller (arming vane). The propeller is held by a lock pin on a set-back collar. Propeller and collar are held in position in storage and transit by a safety wire which must be removed just prior to loading the rocket into the launcher. On firing, set-back releases the propeller which turns in the air stream, advancing the firing pin until the detonator shutter is free; then the detonator moves into line with the firing pin and booster lead. The burster is assembled to the fuze and a shipping guard is taped over the propeller as issued.

#### b. Inspection Prior to Use.

(1) Remove propeller guard. Inspect fuze for corrosion, damaged threads, bent vanes, and other evidences of unserviceability. Bent vanes may be straightened but other defects require destruction of the fuze.

(2) Be sure that the lock pin prevents the propeller from turning in either direction.

(3) Remove safety wire and push down on the propeller lock pin to be sure the set-back collar is free to move, and that it springs back into position. Be sure the propeller is not permitted to turn during this test. Replace safety wire.

(4) If fuze is not to be used immediately, replace propeller guard and return fuze to packings.

### 15. ASSEMBLY OF COMPLETE ROUNDS.

#### a. HE Rocket T37.

(1) Remove the shipping plug from the rocket shell. Inspect the cavity to make certain it is clean and free from foreign matter.

7.2-INCH MULTIPLE ROCKET LAUNCHER M17

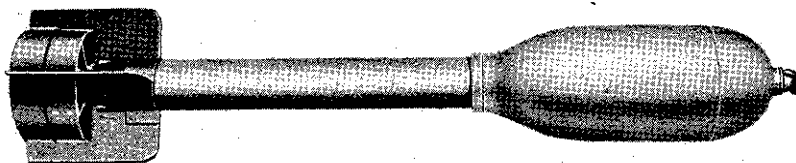

RA PD 58544

Figure 22—Chemical Rocket T21, Assembled

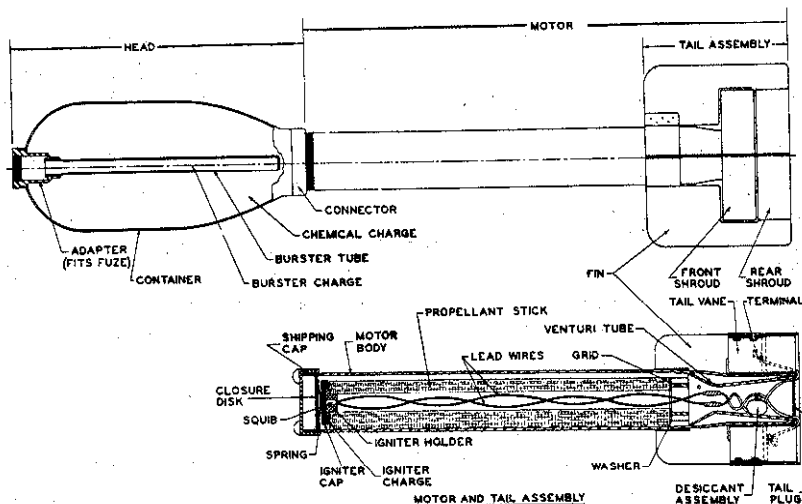

RA PD 58543

Figure 23—Rocket T21, Components

(2) Screw the motor adapter into the opening in the back of the rocket shell. Tighten the adapter securely.

(3) Screw the rocket motor fully into the motor adapter. Back the motor off one-half turn. Hold the rocket shell securely and turn the motor quickly to seat it firmly in the shell.

(4) Remove the short-circuiting clip from the stabilizer fins.

**b. Chemical Rocket T21.**

(1) Remove shipping plugs from motor and shell. Inspect for clear threads and absence of foreign material.

(2) Screw the motor into the shell and tighten with a pipe wrench.

(3) Insert fuze and burster assembly into well and screw in hand-tight. Do not use force.

## AMMUNITION

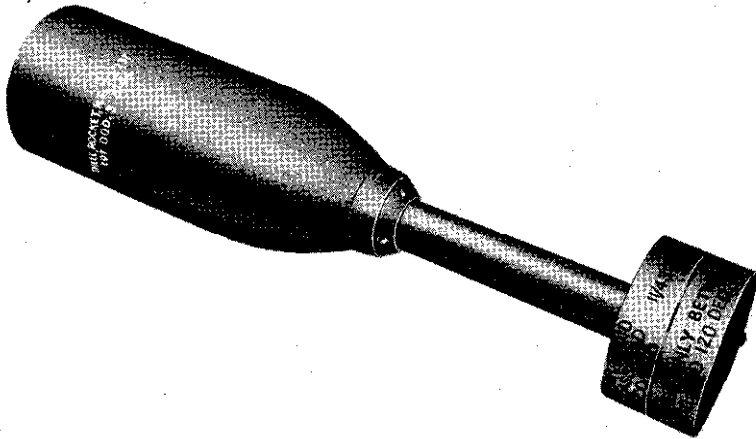

RA PD 50472

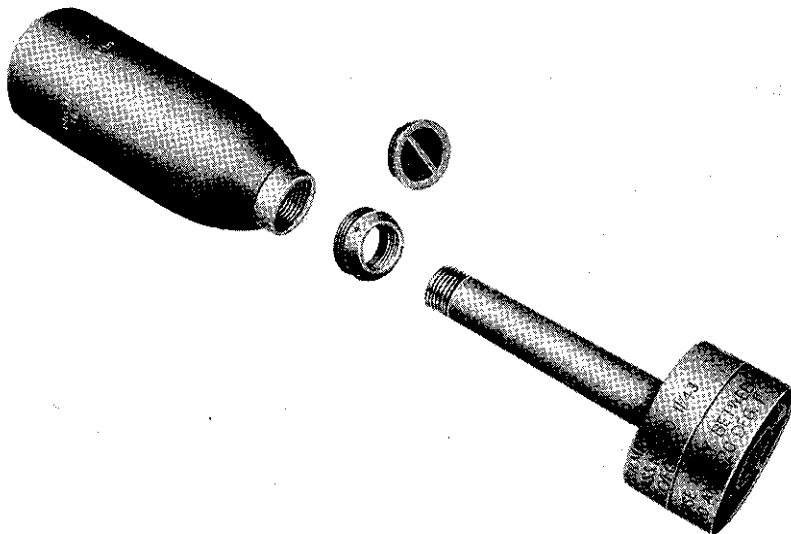
**Figure 24—HE Rocket T37, Assembled**

RA PD 50473

**Figure 25—Rocket T37, Components**

(4) Remove short-circuiting clip from shrouds and propeller guard and safety wire from fuze.

c. **Return to Storage.** In case the rocket is not fired, disassemble and return components to original condition and packings.

TM 9-396  
16-17

7.2-INCH MULTIPLE ROCKET LAUNCHER M17

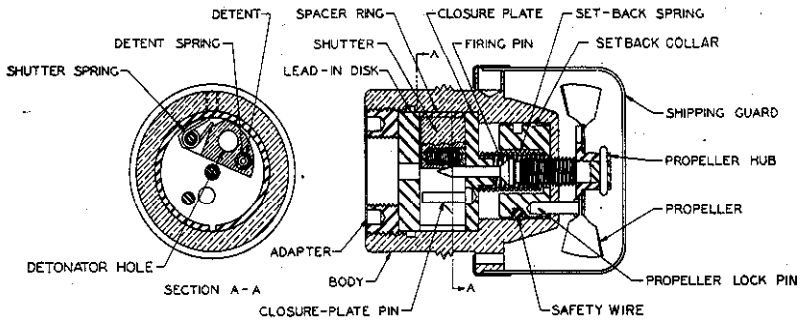

RA PD 58545

Figure 26—Fuze Mk. 147, Sectional View

16. PRECAUTIONS.

- a. Do not fire the round below 10°F or above 120°F.
- b. The rearward blast of the rocket may cover 60 feet. Personnel and combustible materiel must be clear of the rearward blast.

17. RANGE DATA.

- a. The range elevation data in the tables below are provisional and may be changed to agree with observation of fire.

TABLE I.

PROVISIONAL FIRING TABLE—ROCKET, HE, 7.2", T37

CAUTION: Note that all ranges are given in feet.

| RANGE<br>(feet) | ELEVATION (mils) |      |       |
|-----------------|------------------|------|-------|
|                 | TEMPERATURE      |      |       |
|                 | 10°F             | 70°F | 120°F |
| 50              | 85               | 48   | 40    |
| 100             | 118              | 80   | 71    |
| 150             | 150              | 111  | 103   |
| 200             | 185              | 143  | 136   |
| 250             | 220              | 176  | 170   |
| 300             | 260              | 210  | 204   |
| 400             | 338              | 281  | 276   |
| 500             | 430              | 364  | 364   |
| 600             | 548              | 462  | 462   |



## CARE AND MAINTENANCE

TABLE II.  
PROVISIONAL FIRING TABLE—ROCKET,  
CHEMICAL, 7.2", T21

CAUTION: Note that all ranges are given in yards.

| RANGE *<br>(yards) | ELEVATION<br>(mils) | TIME OF<br>FLIGHT<br>(seconds) | PROBABLE<br>Range<br>(yards) | ERROR**<br>Deflection<br>(mils) |
|--------------------|---------------------|--------------------------------|------------------------------|---------------------------------|
| 200                | 62                  | 1.1                            | 190                          | 26                              |
| 400                | 87                  | 2.0                            | 180                          | 26                              |
| 600                | 112                 | 3.0                            | 173                          | 26                              |
| 800                | 137                 | 4.0                            | 167                          | 26                              |
| 1,000              | 164                 | 5.0                            | 162                          | 26                              |
| 1,200              | 192                 | 6.1                            | 158                          | 26                              |
| 1,400              | 222                 | 7.2                            | 154                          | 26                              |
| 1,600              | 252                 | 8.4                            | 150                          | 26                              |
| 1,800              | 284                 | 9.6                            | 145                          | 26                              |
| 2,000              | 316                 | 10.8                           | 139                          | 26                              |
| 2,200              | 352                 | 12.0                           | 131                          | 26                              |
| 2,400              | 389                 | 13.4                           | 122                          | 26                              |
| 2,600              | 430                 | 14.9                           | 110                          | 26                              |
| 2,800              | 478                 | 16.5                           | 96                           | 26                              |
| 3,000              | 533                 | 18.3                           | 79                           | 26                              |
| 3,200              | 604                 | 20.9                           | 59                           | 26                              |
| 3,400              | 722                 | 24.1                           | 35                           | 26                              |

\*With respect to the muzzle.

\*\*Single shot fire.

NOTE: Maximum range: 3,430 yd (at 764 mils elevation). Effect of change in temperature of powder is negligible.

## Section V

## CARE AND MAINTENANCE

## 18. ADJUSTMENT OF INDICATOR LIGHT SWITCH.

CAUTION: The following operations may be performed with rocket in launcher rail but safety plug must first be removed from firing mechanism box.

- a. Open the cover for the electrical leads at rear of launcher.
- b. Remove lead to microswitch from its clip (fig. 27).

7.2-INCH MULTIPLE ROCKET LAUNCHER M17

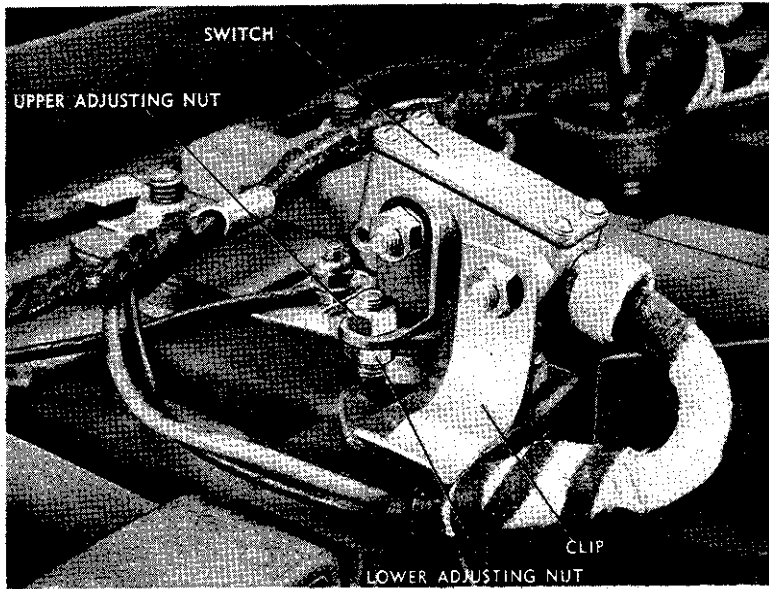

RA PD 90766

Figure 27—Adjusting Microswitch

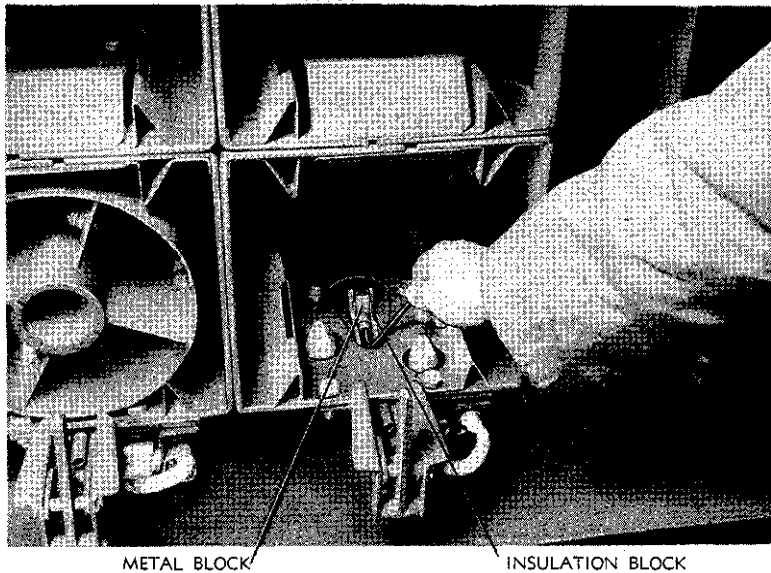

RA PD 90745

Figure 28—Replacement of Tail Latch Insulation Block

## INSTALLATION OF LAUNCHER

c. Back up the lower adjusting nut and tighten the upper adjusting nut until the switch becomes operative and indicator lamp on dial illuminates when rocket is in launcher rail.

### 19. REPLACEMENT OF TAIL LATCH INSULATION BLOCK.

a. The tail latch insulation block will, through use, become distorted and worn so that the metal block in front of the insulation block will fail to make contact with stabilizer ring of rocket. This may result in a short circuit with a resulting misfire.

b. To replace the insulation block, proceed as follows: Unscrew the Allen set screw from metal block (fig. 28), and remove the metal block and insulation block. Replace insulation block and assemble.

---

## Section VI

## INSTALLATION OF LAUNCHER

**CAUTION:** *This installation to be performed by ordnance personnel only.*

### 20. GENERAL.

a. The launcher can be installed on the tank with or without the use of the assembling jig as described in paragraphs 21 and 22.

b. Before proceeding to install the launcher by either method, the following parts must be removed from the tank turret:

(1) Remove the gun rest traveling clip from the top of the latch ring (fig. 29).

(2) Remove the gun front sight vane from the top of the turret (fig. 29).

(3) Remove the guard and cover from periscope on left side of turret (fig. 29).

(4) Remove 3 inches of metal at 30-degree angle on rear of aerial cup on turret (fig. 29).

### 21. INSTALLATION OF LAUNCHER BY MEANS OF ASSEMBLING JIG.

a. **Assembling Jig.** The assembling jig is a device for determining the positions at which the tank attachments which support the launcher and facilitate its jettisoning are to be welded to the tank turret.

## 7.2-INCH MULTIPLE ROCKET LAUNCHER, M17

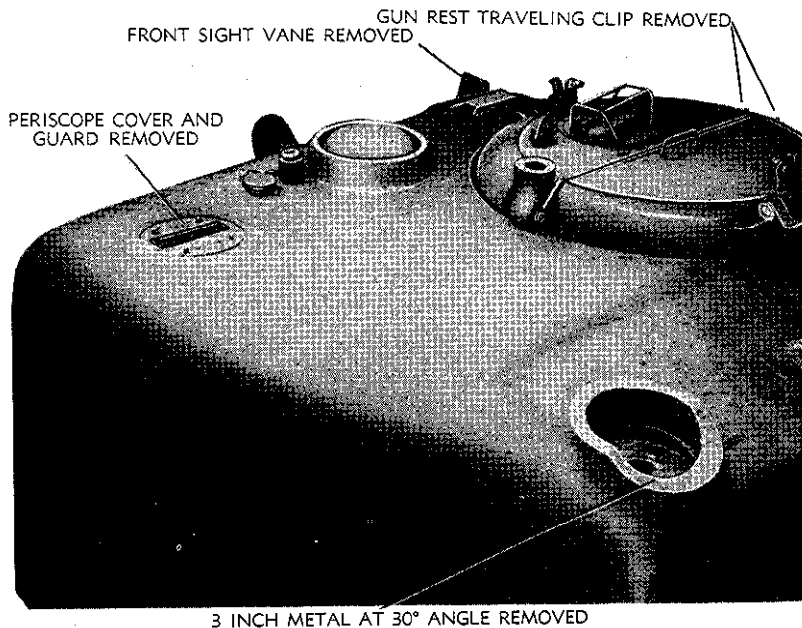

RA PD 90734

**Figure 29—View of Tank Turret Showing Parts Removed**

**b. Welding of Tank Attachments.**

- (1) Level the tank and set the 75-mm gun in the turret at zero elevation and zero traverse.
- (2) Open turret hatch door to rear and set the assembling jig over the turret (figs. 30 and 31). Aline it so that stop plate bears against muzzle of gun and clamp it on the gun.
- (3) Check the gage plates to center, and level the jig on the machined turret surface by adjusting the set screws on the jig.
- (4) Cut templates for each of the trunnion pin brackets (fig. 32), mark the brackets from these templates, and cut along the lines. Fit the brackets to the jig and weld to the turret (fig. 33).
- (5) Cut a template from heavy cardboard for one of the trunnion latch plates so that it fits snugly between the jig and the turret. Mark the latch plate from this template and cut to the line. Fit the latch plate to the jig and weld to the turret (fig. 34).
- (6) Cut templates for each of the jettison roller brackets (fig. 35), mark the brackets from these templates, and cut along the lines. Remove the rollers from the brackets, fit the brackets to the jig, and

INSTALLATION OF LAUNCHER

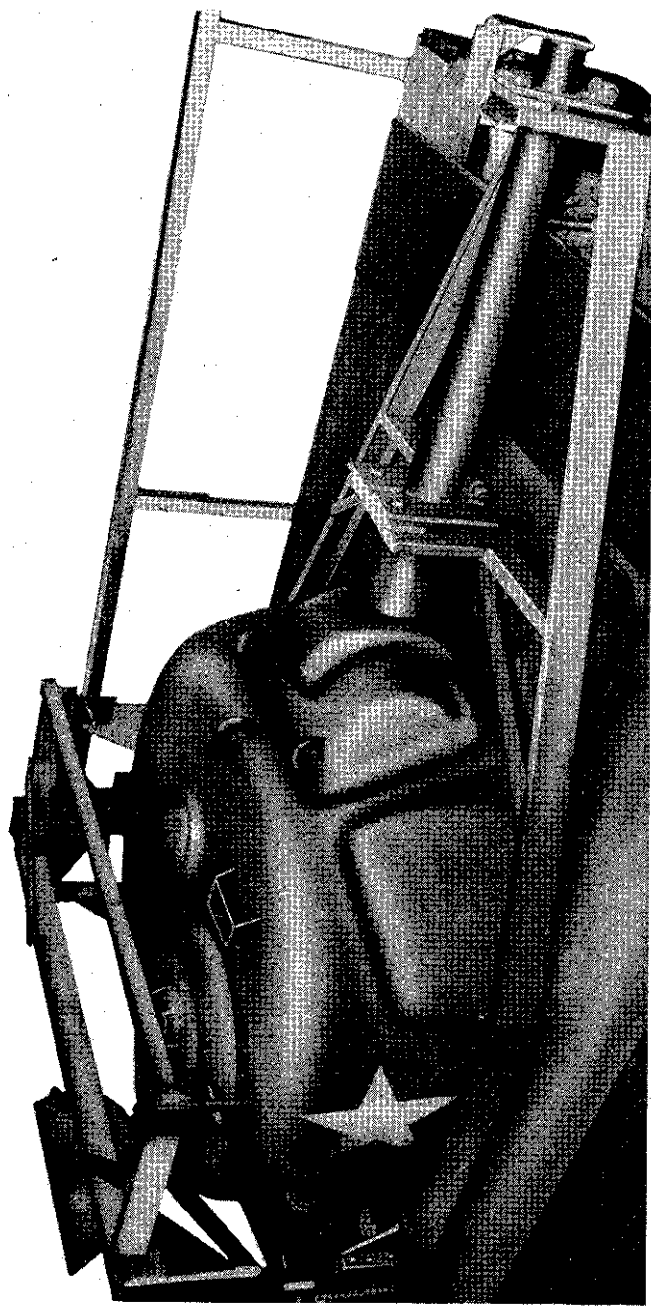

RA PD 90748

Figure 30—Assembling Jig on Tank—Front View

TM 9-396

21

7.2-INCH MULTIPLE ROCKET LAUNCHER M17

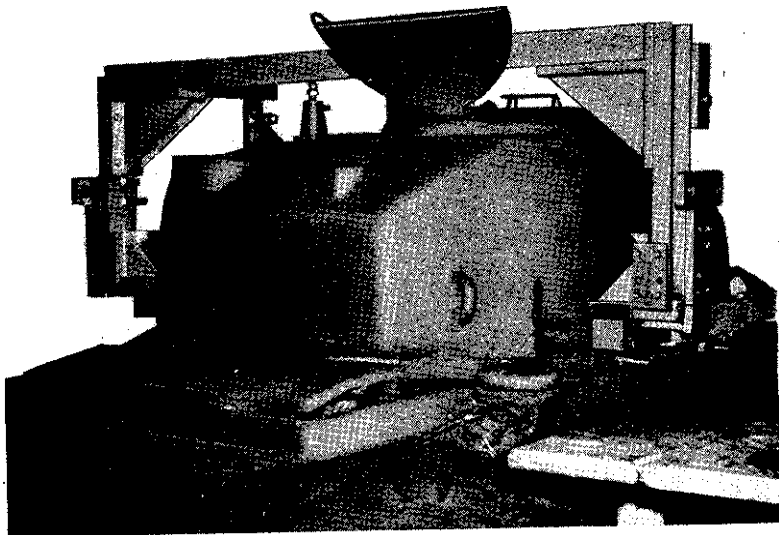

RA PD 90749

*Figure 31—Assembling Jig on Tank—Rear View*

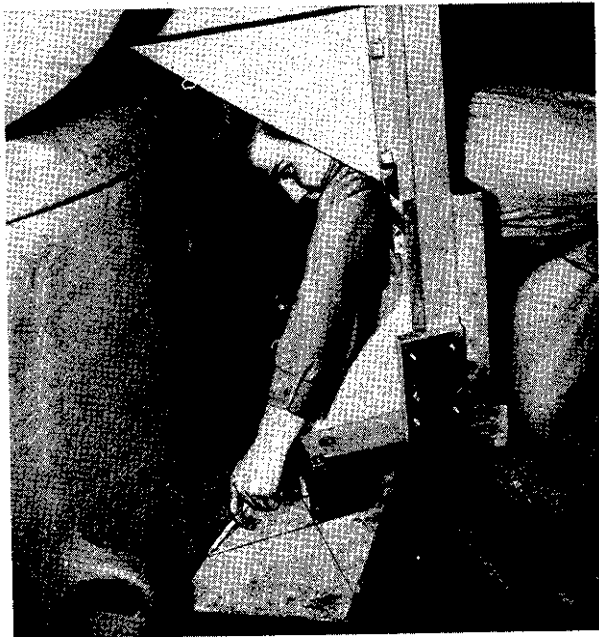

RA PD 90750

*Figure 32—Cutting Templates for the Trunnion Pin Brackets*

INSTALLATION OF LAUNCHER

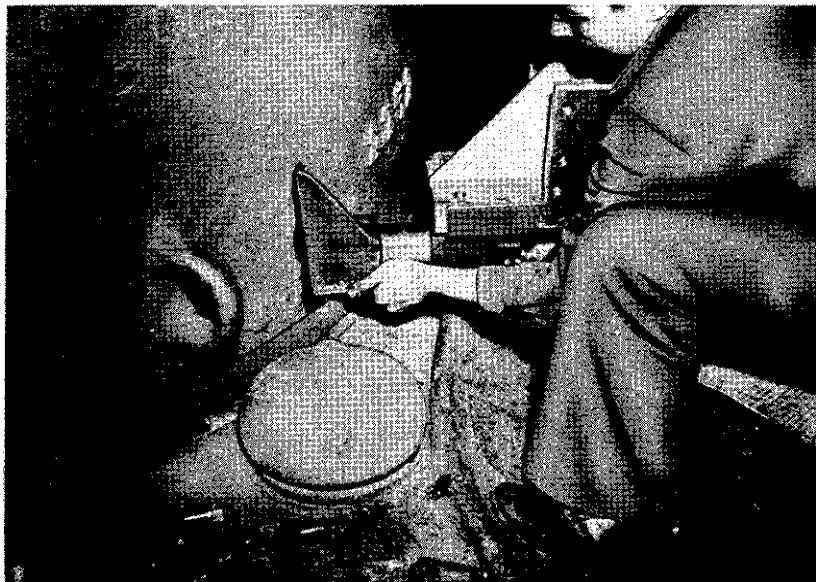

RA PD 90751

**Figure 33—Fitting Trunnion Pin Bracket to Turret To Be Welded**

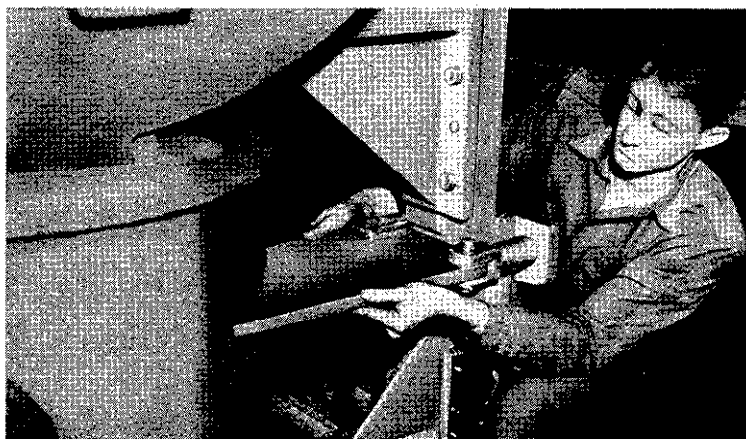

RA PD 90752

**Figure 34—Fitting Trunnion Latch Plate to Turret To Be Welded**

7.2-INCH MULTIPLE ROCKET LAUNCHER M17

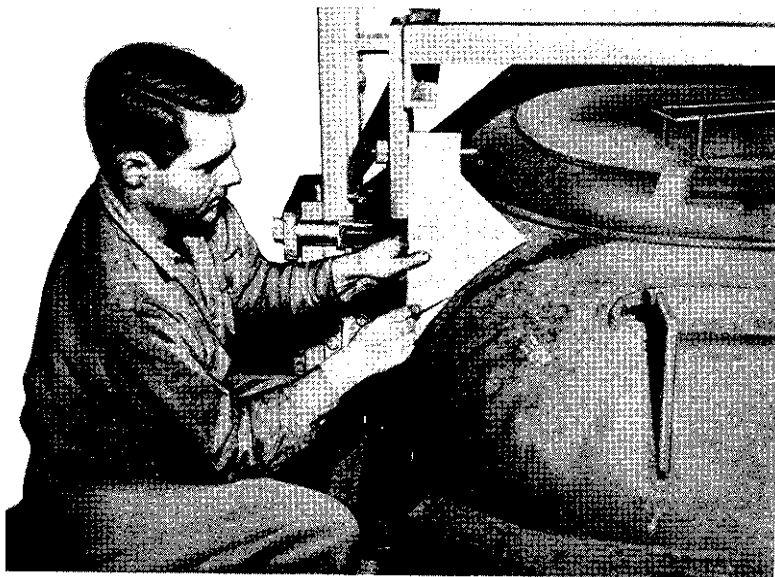

RA PD 90753

**Figure 35—Cutting Template for Jettison Roller Bracket**

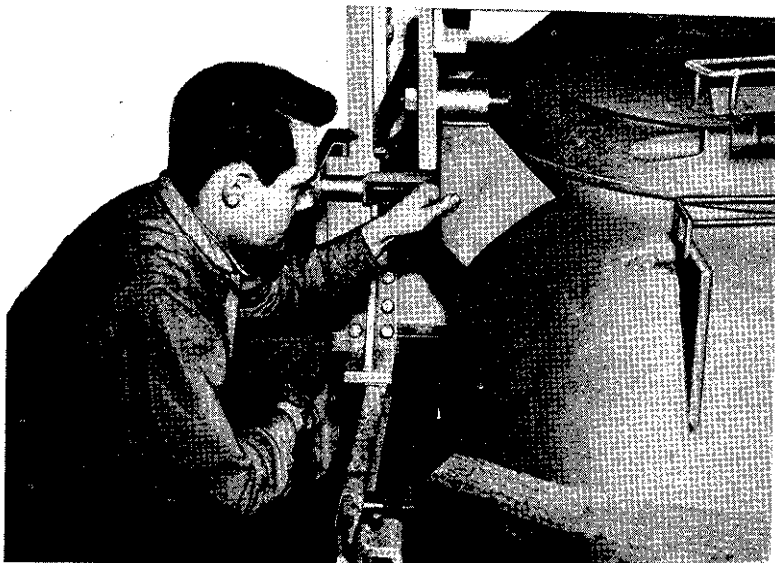

RA PD 90754

**Figure 36—Fitting Jettison Roller Bracket to Turret To Be Welded**



INSTALLATION OF LAUNCHER

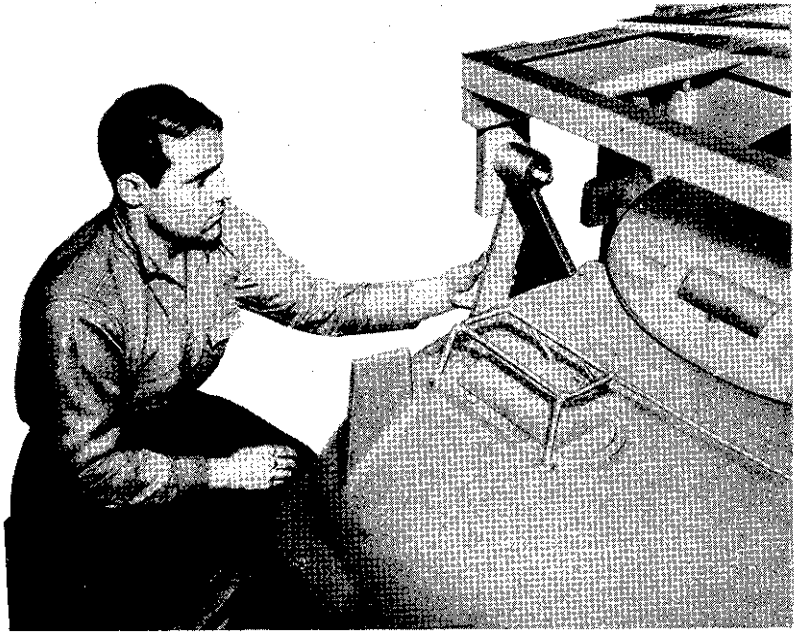

RA PD 90755

Figure 37—Fitting Support to Bracket and Turret To Be Welded

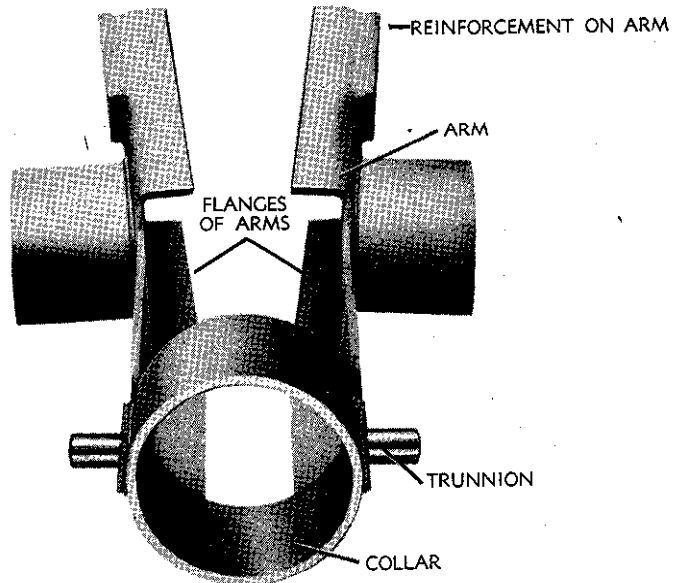

RA PD 90756

Figure 38—Gun Shield Adapter

**7.2-INCH MULTIPLE ROCKET LAUNCHER M17**

weld to the turret (fig. 36). Fit support to bracket and weld (fig. 37). Replace rollers on brackets.

*NOTE: Use modified 18-8 welding rods. Temperature of turret and parts to be welded should not be less than 70° F.*

(7) Remove the jig from the turret.

(8) Measure and mark on the 75-mm gun tube a position 42 inches out from the center of the gun trunnion. Slip the gun shield adapter (fig. 38) over the gun so that the adapter arms contact the gun shield. The long flanges of the arms are below the gun and parallel to its center line, and the trunnions on the adapter collar are horizontal. If the end of the adapter collar is exactly at the 42-inch mark on the gun, shim the collar so that it is equally spaced around the gun tube, and the adapter trunnions are exactly horizontal. Weld the adapter to the gun shield, using 5132 Chro-Mang "ARCO" welding rod or equivalent. It is important to place as much weld as practical at the top where the reinforcements on the arms abut the gun shield. The gun shield may be of such a type that the arms of the adapter must be shortened to allow the end of the adapter collar to come to the 42-inch mark on the gun tube. In this case, the arms must be burned off to fit the gun shield so that the 42-inch position of the collar is maintained and the adapter trunnions are horizontal. Shim the collar and weld the adapter to the gun shield as described above.

**c. Installation of Quadrant Assembly.**

(1) Disconnect the holder link from the periscope holder and from the adjusting rod of gun elevation mechanism (fig. 39).

(2) Remove the holder connector from the quadrant (fig. 14) and assemble it to the periscope holder.

(3) Remove the adjusting rod fitting from the quadrant (fig. 14) and assemble it to the adjusting rod.

(4) Make certain tank is level and gun is at zero elevation and zero traverse.

(5) Connect the quadrant to the adjusting rod and holder connector by means of the linkage (connections should be such as to allow leeway for adjustments described below).

(6) Tack the quadrant on to the ceiling of the turret so that there is no binding on linkage and indicator is at about zero on range plate.

(7) Weld quadrant in this position (fig. 40).

(8) Bore sight on a distant object at least 1,000 yards away, sight through periscope on same object, adjust nuts on holder connector (fig. 14) until bubble is level, and clamp the elevation scale plate in this position.

INSTALLATION OF LAUNCHER

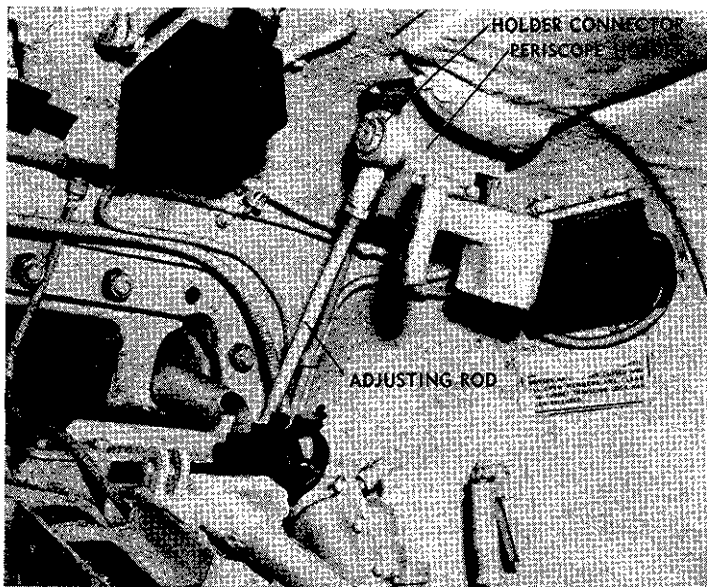

RA PD 90757

**Figure 39—Periscope Holder, Connector, and Adjusting Rod**

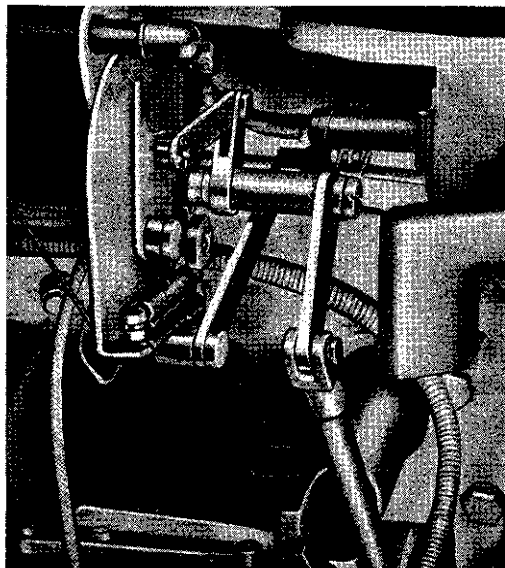

RA PD 90758

**Figure 40—Quadrant Assembly in Position in Turret**

**7.2-INCH MULTIPLE ROCKET LAUNCHER M17**

(9) Adjust rod fitting by means of nut on rod until indicator reads zero on elevation scale plate.

(10) Splice the lead from the light bulb on quadrant to the lead for dome light on left side of gun.

**d. Installation of Firing Mechanism.**

(1) Engage the bottom brackets of the firing mechanism box over the rim edge of the turret base and bolt the upper bracket, using two bolts in ring gear apron in lower rear position of turret (fig. 41).

(2) Remove the cover from the gun firing terminal box. Attach the lines of the 24-volt battery lead as shown in figure 42. Position grommet in hole of gun firing terminal box. Replace cover on gun firing terminal box.

(3) Plug the firing cable and indicator light cable into the proper receptacles on the firing mechanism box.

**e. Installation of Transmitters.**

(1) Remove bracket for holding the fire extinguisher from left side of turret operating compartment. Relocate fire extinguisher bracket on bottom rim edge of turret compartment and weld in place.

(2) Mount the bracket for holding the three transmitters on left side of turret interior and secure it, using the second and third horizontal bolts in ring gear apron forward of basket rib on which assistant gunner's seat is mounted, and the two vertical bolts in ring gear support ledge (fig. 43).

(3) Mount the two transmitters by using second and third horizontal bolts to rear of basket rib on which assistant gunner's seat is mounted (fig. 43).

**f. Mounting the Launcher.**

(1) Lift launcher, using wire rope sling. Position it over the tank turret so that launcher doors face muzzle of gun.

(2) Place a wooden block on turret near gun shield. This is to keep launcher level and prevent its tilting over on gun shield.

(3) Swing the hinged pins on latch plates out to rear. Remove nuts from elevating trunnions, fixed pins of latch plates, and trunnion pin brackets. Place lower ends of trunnion supports over the trunnion pin brackets and draw trunnion supports forward so that they bear against the fixed pins of the trunnion plate latches. Maneuver the launcher so that the elevating trunnions on the launcher fit into their bearings in top of the trunnion supports. Push the trunnion supports home on the elevating trunnions and trunnion pin brackets (fig. 44).

### INSTALLATION OF LAUNCHER

GUN FIRING TERMINAL BOX

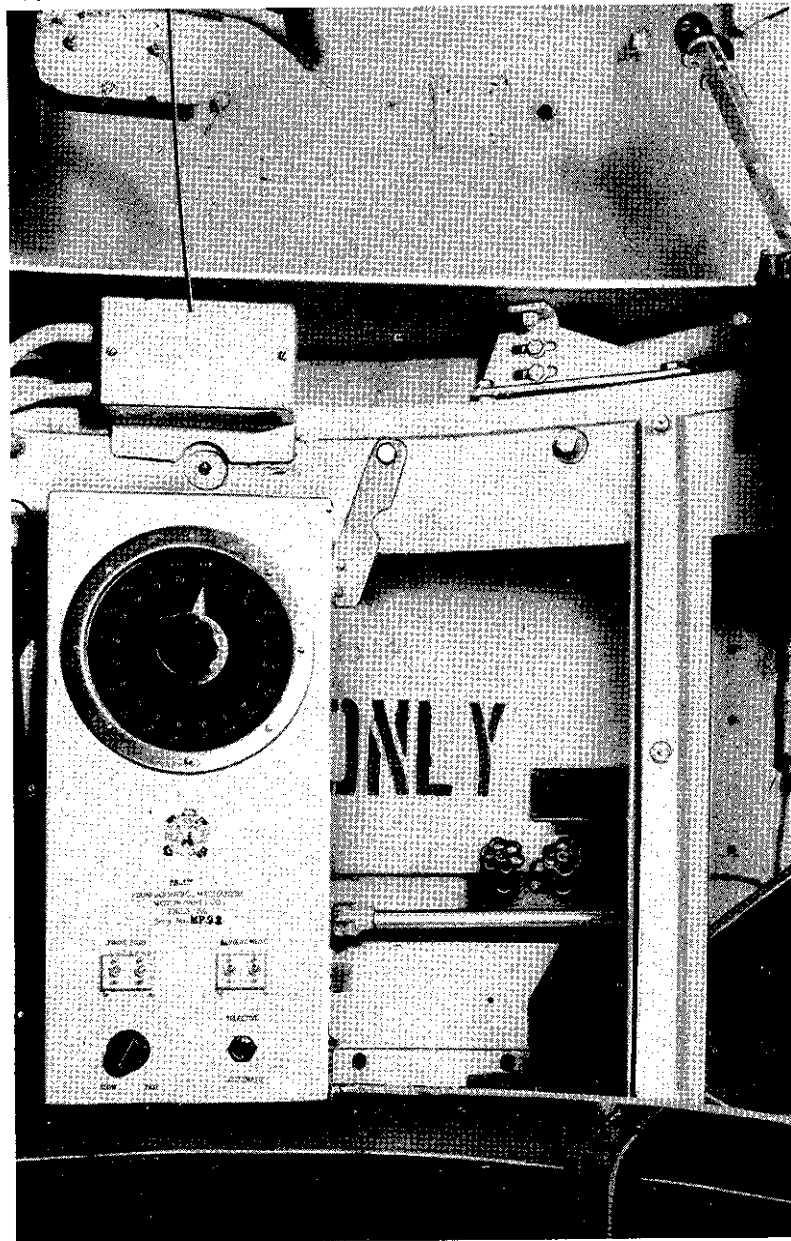

RA PD 90735.

**Figure 41—Firing Mechanism Box in Position in Turret**

7.2-INCH MULTIPLE ROCKET LAUNCHER M17

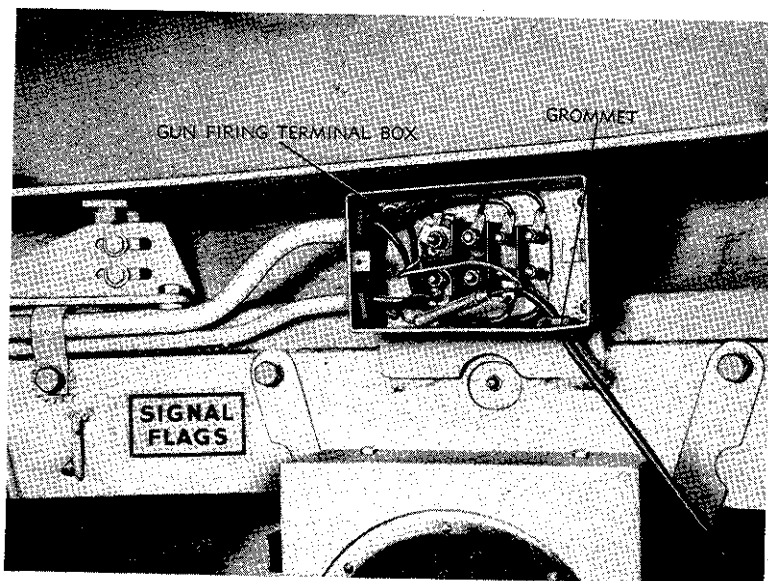

RA PD 90736

Figure 42—Connections for 24-volt Battery Lead to Gun Firing Terminal Box

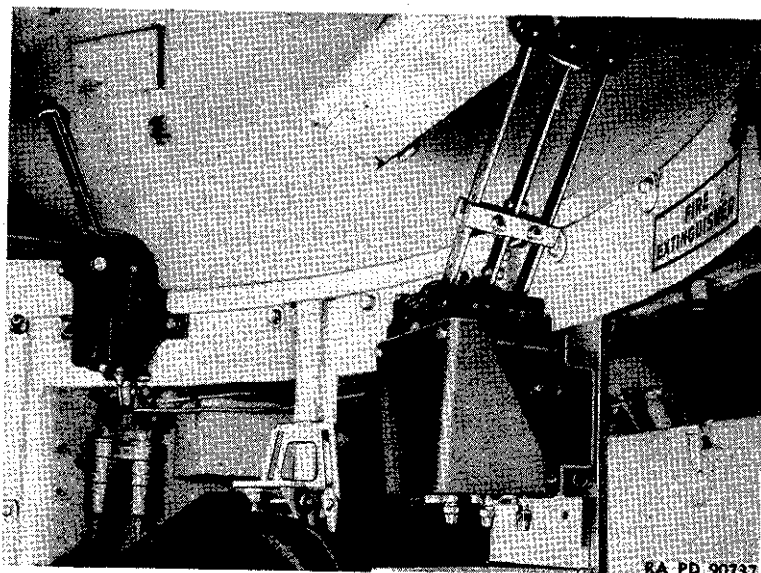

RA PD 90737

Figure 43—Transmitters in Position in Turret

## INSTALLATION OF LAUNCHER

(4) Replace nuts on elevating trunnions, on fixed pins of latch plates, and on trunnion pin brackets (fig. 45).

(5) Swing the hinged pins of the latch plates forward against the rear sides of the trunnion supports and engage with lower jettisoning latches. Clamp the hinged and fixed pins in this position, using "C" clamps (fig. 45).

(6) Raise the front end of the launcher with cable sling until the crossheads at the rear ends of the equilibrator springs can be inserted into the clevis openings, and engage the upper jettisoning latches (fig. 46).

(7) Insert and screw into place the elevating strut (fig. 47). The strut should be screwed in until about 1 inch of the threaded surface is exposed.

(8) Latch the lower arms of the strut to the trunnions of the gun shield adapter (fig. 48).

(9) Drive in the pins to secure the nuts on the elevating trunnions, on fixed pins of latch plates, and on trunnion pin brackets.

(10) Remove the "C" clamps.

(11) Set the launcher at zero elevation.

(12) Connect the links on the strut to the receiver arm. If the holes on the screw fitting and receiver arm do not aline, adjust by means of the screw fitting and adjusting nut (fig. 12).

### g. Installation of Electric and Hydraulic Lines.

(1) Connect the hydraulic line from the launcher to the receiver on the elevating strut.

(2) Connect the hydraulic lines from the launcher to the receivers on the trunnion supports.

(3) Remove the safety wire and disassemble the periscope block assembly to remove the blocks, nipples, and jettison guides (fig. 18).

(4) Install lower block (metal) of the periscope block assembly in the periscope opening in turret and secure with the lock.

(5) Remove the two screws from opposite ends of receptacle on jettison guides and remove the three screws on each side of the jettison guide (fig. 18). Plug the firing cable from launcher into the jettison guide and replace the screws. Similarly connect the indicator light cable from the launcher into the other jettison guide.

(6) Place the two sections of the top block into the jettison guides so that the firing cable and indicator light cable fit snugly in their channels in the block.

(7) Insert the jettison guides with block into the periscope opening.

7.2-INCH MULTIPLE ROCKET LAUNCHER M17

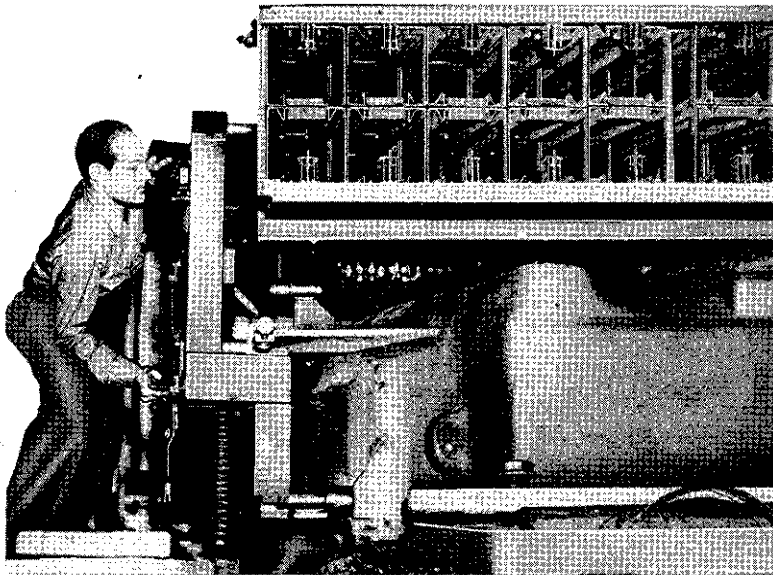

RA PD 90738

Figure 44—Pushing Trunnion Support Into Position

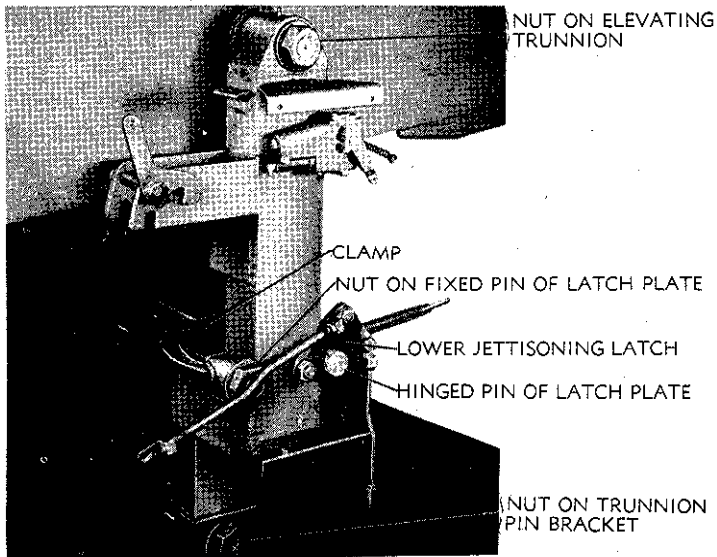

RA PD 90739

Figure 45—Pins of Latch Plate Clamped to Trunnion Support



INSTALLATION OF LAUNCHER

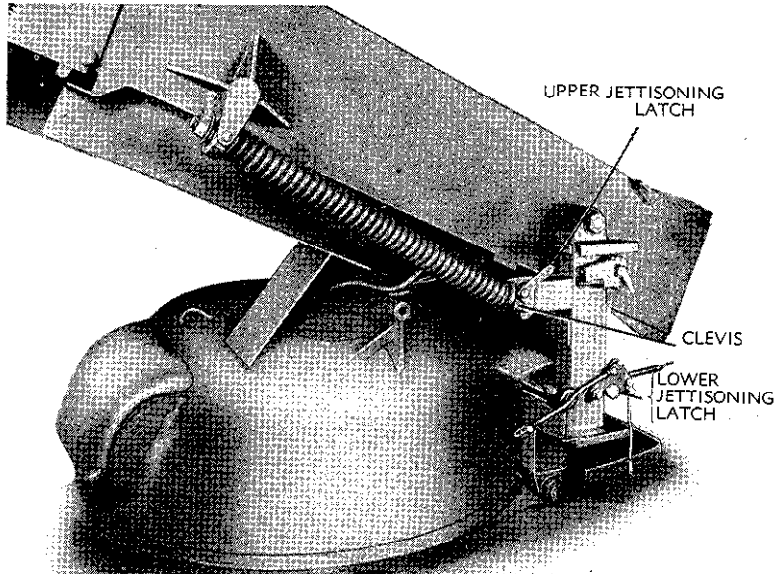

RA PD 90740

**Figure 46—Equilibrator Spring Assembly Engaging Upper Jettisoning Latch**



BLOCK FOR  
SCREWING IN THE  
ELEVATING STRUT

RA PD 90741

**Figure 47—Screwing Elevating Strut Into Block on Launcher**

## 7.2-INCH MULTIPLE ROCKET LAUNCHER M17

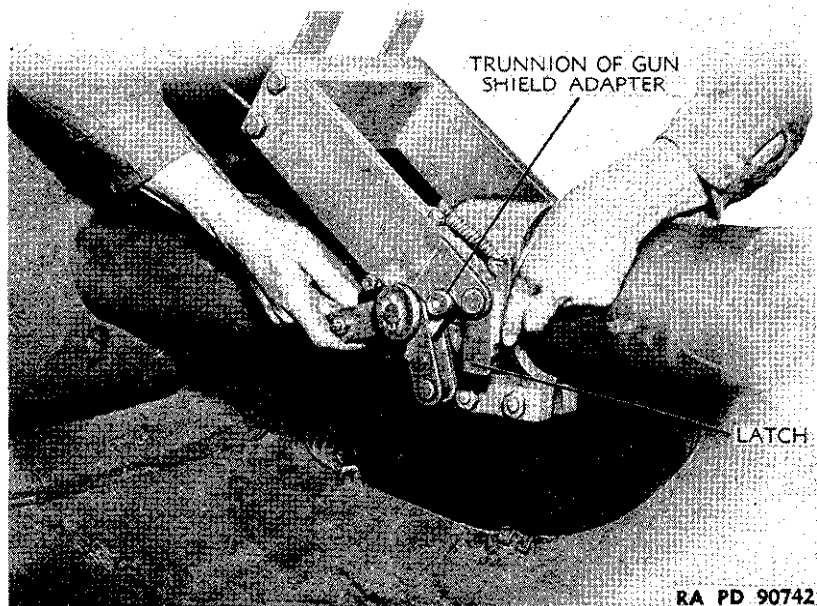

RA PD 90742

**Figure 48—Latching Elevating Strut to Trunnions on Gun Shield Adapter**

(8) Insert the four nipples through the four channels in the top block into the disconnect fittings in the bottom block.

(9) Connect the hydraulic lines from the launcher marked "A," "B," "C," and "D" to the nipples as shown in fig. 49.

(10) Bolt the metal plate with chain to the rear face of the top block (fig. 49). Safety-wire the block (fig. 50).

(11) Connect the hydraulic lines marked "AAA," "BBB," "CCC," and "DDD" between the transmitters and periscope block (fig. 51) in the turret as follows:

(a) Line "BBB" is connected to the left-hand transmitter, which is the transmitter nearest the turret wall. This line is formed, with a short forward bend, to a point immediately in front of the transmitters, at which point it is bent upward, and then to the left as far as the wall of the turret. From here the tube shall follow the contour of the turret to a point even with the periscope block. The tubing is then bent at an angle that will allow it to pass 3 inches below the fitting marked "BBB." A short radius bend up to the fitting marked "BBB" completes the run of the line to the disconnect fitting.

## INSTALLATION OF LAUNCHER

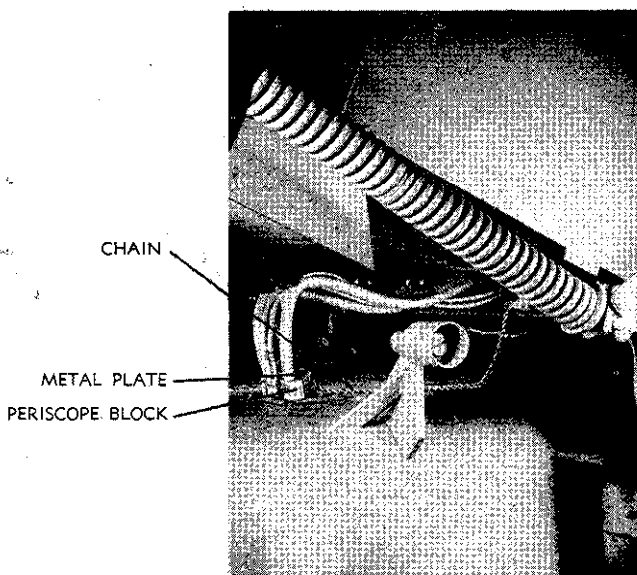

RA PD 90759

**Figure 49—Connections on Top of Periscope Block**

(b) Line "DDD" is connected to the middle transmitter. The tubing should be bent so that it exactly parallels the line "BBB," running up the side of the turret, immediately forward of "BBB," and then is connected to the disconnect fitting marked "DDD."

(c) Line "AAA" is connected to the right-hand transmitter, but should not be formed until line "CCC" is formed and connected. Line "CCC" is then connected and the tubing run along the side of the basket to a position forward of the line "DDD," at which point it is then bent upward and run alongside of "DDD" until it reaches the jettison guides where it is connected to the fitting marked "CCC." When this line is connected, line "AAA" is bent so that it will follow immediately beside line "CCC" and connect to fitting marked "AAA."

(12) Plug one end of firing cable into proper receptacle on jettison guide and the other end into receptacle on left side of firing mechanism box (fig. 52).

(13) Plug one end of indicator light cable into receptacle on jettison guide and other end into receptacle on right side of firing mechanism box (fig. 52).

(14) Plug the 24-volt battery lead into the receptacle on right side of firing mechanism box (fig. 52).

7.2-INCH MULTIPLE ROCKET LAUNCHER M17

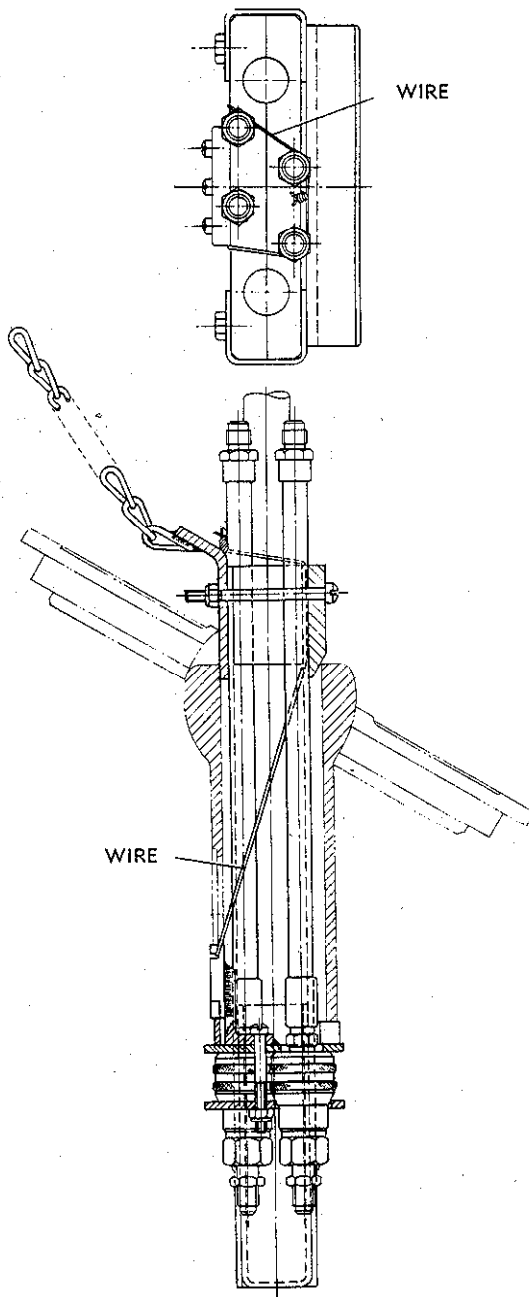

RA PD 90760

Figure 50—Method of Safety-wiring Block

## INSTALLATION OF LAUNCHER

(15) Plug the firing cable (with trigger) into receptacle on left side of firing mechanism box (fig. 52).

### h. Filling of Hydraulic Systems for Jettisoning.

(1) Disconnect all mechanical linkage to the receivers on the elevating strut and trunnion supports.

(2) Remove the handle clamp which holds the three transmitter handles together.

(3) Disconnect the tubing at one receiver.

(4) Remove the knurled filler cap from the transmitter which connects to the receiver. (It is easy to determine which transmitter to operate in order to fill the proper line, as *each continuous line throughout the system carries the same letter*—for example: Line "A" connects to line "AA," line "AA" connects "AAA," etc.)

(5) Fill the transmitter with hydraulic brake fluid (Federal Stock No. 51-F-360-725).

(6) Station one man at the receiver. The man at the receiver will place his thumb over the end of the tubing, thus sealing it off, while the operator in the turret pushes the transmitter handle forward to the end of the stroke. This motion draws fluid from the reservoir into the cylinder of the transmitter.

(7) Hold transmitter handle forward and keep end of line closed for about one second after completing the forward stroke.

(8) As operator in the tank starts to move the transmitter handle to the rear again, the man stationed at the receiving end of the tubing will remove his finger, thus allowing the air in the tubing to escape. This motion pumps oil from the transmitter into the line.

(9) This procedure must be repeated several times until the oil starts to flow from the receiver end of the tubing. Always allow a small amount of fluid to escape to assure the line being free of air, and then connect the tubing to the receiver. While this connection is being made, move transmitter handle slowly to rear to prevent air from being drawn into the line.

(10) Steps should be taken at the end of every few strokes to refill the transmitter. This prevents air from being sucked into the system at the transmitter end.

(11) In a similar manner, fill the other two transmitters of the jettisoning unit.

(12) After all three hydraulic jettisoning systems have been filled, they must be checked for satisfactory operation as follows:

(a) The operator moves the transmitter handle to full forward position and then he moves it to the end of its stroke, which will move the receiver arm to its full upward position.

7.2-INCH MULTIPLE ROCKET LAUNCHER M17

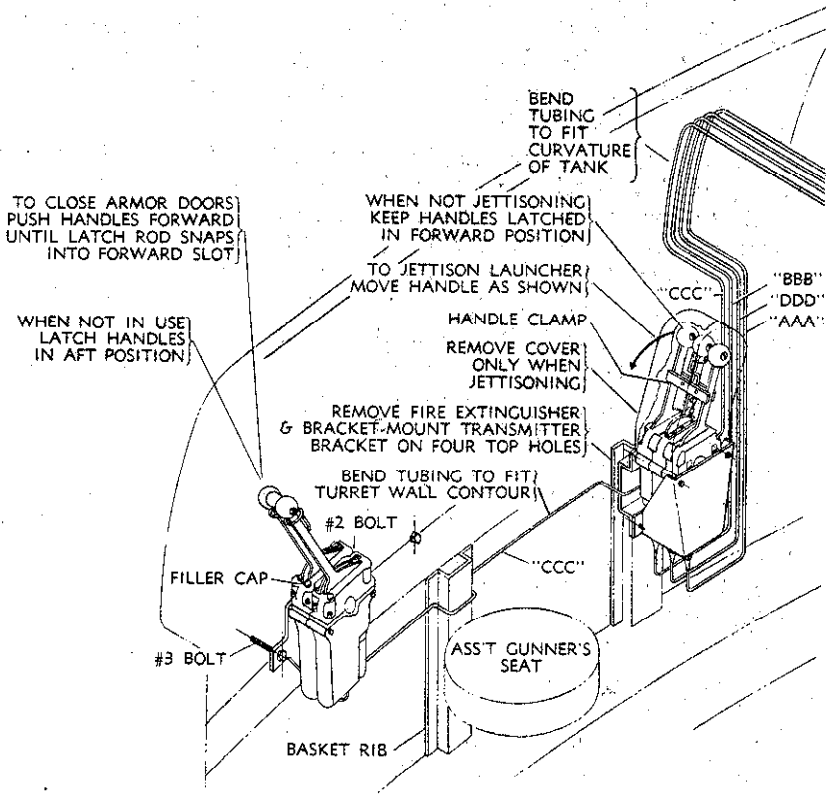
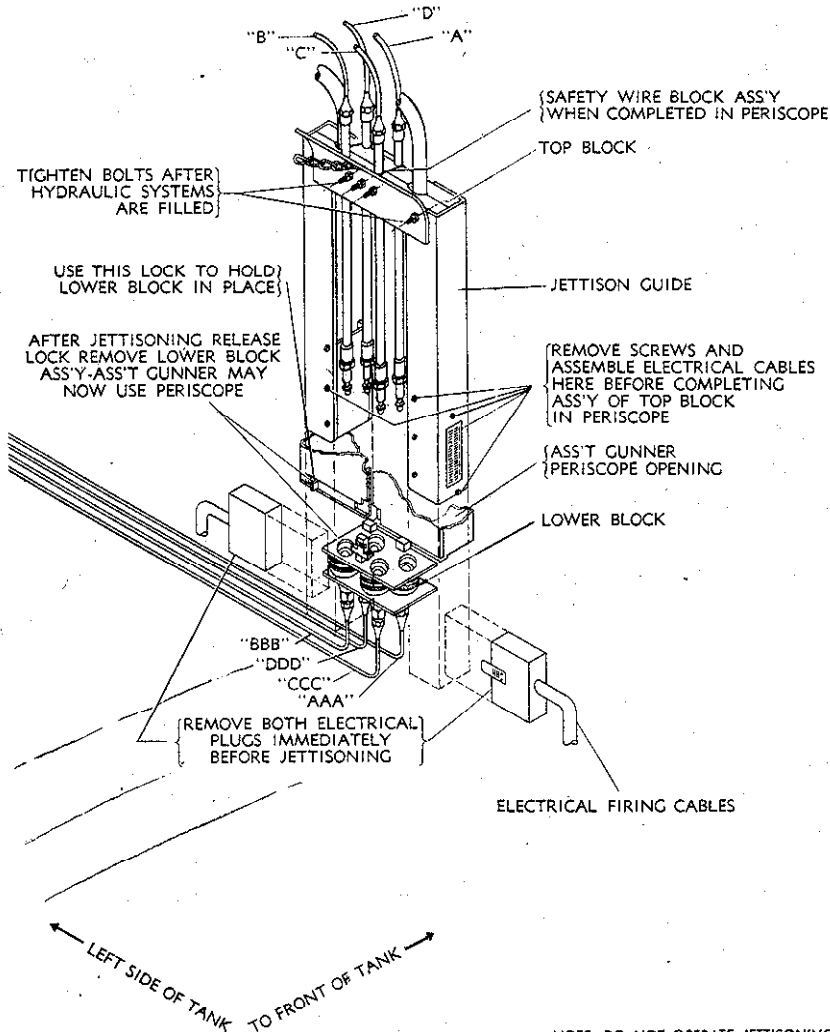

Figure 51—Connections to

INSTALLATION OF LAUNCHER



NOTE: DO NOT OPERATE JETTISONING  
CONTROLS UNLESS AUTHORIZED

RA PD 90761

## 7.2-INCH MULTIPLE ROCKET LAUNCHER M17

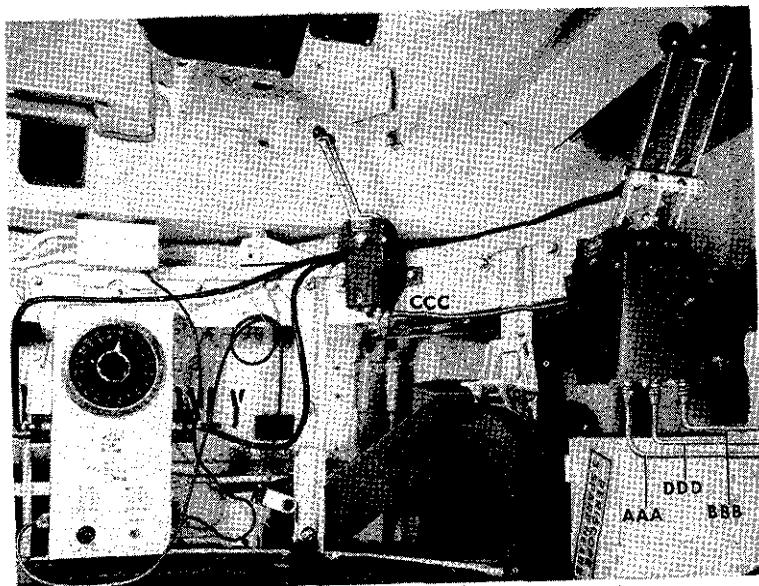

RA PD 90746

**Figure 52—Connections to Firing Mechanism Box and Transmitters**

(b) Let the unit stand for 5 to 10 minutes and check any movement that the receiver arm has made. There should not be any change in the position of the transmitter handle or receiver lever. *If there is any movement*, of either receiver arm or transmitter handle, connections and joints should be checked for leakage.

(c) If a receiver does not make a full stroke immediately after connecting the tubing, and after pumping transmitter a few strokes, air may be removed from the system by slightly loosening the flare nut on the tubing at the receiver fitting, which will permit air and a small amount of oil to escape. **NOTE:** *Operate only the transmitter connected to the line being filled.*

(13) After all three transmitters have been filled and checked, the three handles should be clamped together, latched in forward position, and protected with the cover. Cover must not be removed until ready to jettison launcher.

**i. Filling of Hydraulic Systems for Operation of Doors.** There are two transmitters but it is not necessary to fill these transmitters separately. Operate both transmitters at the same time, keeping them filled with fluid. Follow instructions given above.



## INSTALLATION OF LAUNCHER

### j. Adjustment of Links.

(1) After all hydraulic systems have been filled and checked, safety-wire all latches in the latched position.

(2) Connect the link to the receiver on each trunnion support. It should be possible to connect lever arm to screw fitting without forcing. If necessary, adjust by means of screw fitting and adjusting screws.

(3) Connect and adjust the link between the upper and lower jettisoning latches so that it has a free play of one-eighth inch.

k. After the links have been adjusted and connected, remove the safety wire from the latches, and bolt the armor plate covers to the elevating strut and trunnion supports.

## 22. INSTALLATION OF LAUNCHER WITHOUT THE ASSEMBLING JIG.

a. Installation of Quadrant Assembly. Proceed as in paragraph 21 c.

b. Installation of Firing Mechanism. Proceed as in paragraph 21 d.

c. Installation of Transmitters. Proceed as in paragraph 21 e.

### d. Welding of Tank Attachments.

(1) Set the tank level, and the 75-mm gun at zero elevation and zero traverse.

(2) Use the center line of the gun at the point where it crosses the turret surface as a point of origin and determine the 90-degree, 180-degree, and 270-degree points on the top of the machined surface of the turret. Draw a line over the turret between the 90-degree and 270-degree points, and a line between the zero-degree and 180-degree points.

(3) Use the top of the machined surface of the turret as a base, erect a perpendicular, and lay off the distances of  $5\frac{1}{2}$  inches and 23 inches from the base. Through the points thus marked, draw lines on the turret surface parallel to the top of the machined surface. The line  $5\frac{1}{2}$  inches distant from machined surface corresponds to horizontal center line of trunnion pin bracket; the line 23 inches distant from the top of the machined surface corresponds to horizontal center line of the trunnion latch plate (fig. 53).

(4) Determine the mid-point on the launcher between the elevating trunnions. Mark this point and carefully extend it to the front and rear of launcher.

**7.2-INCH MULTIPLE ROCKET LAUNCHER M17**

(5) Make certain gun is at zero elevation and zero traverse. Then weld the gun shield adapter to the gun shield (par. 21 b (8)).

(6) Lift launcher over the turret and screw the elevating strut into block on launcher until about 1 inch of threaded surface is exposed (fig. 47). Latch the elevating strut to the trunnions of the gun shield adapter (fig. 48). Do not connect link to the receiver on the strut.

(7) Assemble the left and right trunnion supports to the elevating trunnions on the launcher and secure with the nuts.

(8) Steady the launcher over the turret in accordance with the following conditions (use blocking if necessary):

(a) Launcher must be level and trunnion supports vertical.

(b) Center line of gun, elevating strut, mid-point line on launcher, and 180-degree mark on rear of turret must aline.

(c) Horizontal center line of bearing for trunnion pin bracket must aline with the 5½-inch line.

(d) Horizontal center line of lower jettisoning latch pivot on trunnion support must aline with 23-inch line.

(e) Distance from center line of trunnion support to a line erected at 90-degree and 270-degree points on turret and parallel to front side of support must be 25 inches.

(9) Fit and cut templates from trunnion supports to turret surface at points of trunnion pin brackets and latch plates.

(10) Cut and grind brackets and plates to suit template patterns and turret surface.

(11) Weld the brackets and plates to the turret. Use modified 18-8 welding rods. Temperature of turret and parts to be welded should not be less than 70° F.

(12) Fit a template to the turret on the 90 degrees-270 degrees line; cut template so that it is 4¼ inches above turret top. This line determines the vertical position of the roller bracket on the turret. Drop a perpendicular from the roller rail of the launcher to the top of the template. This intersection corresponds to the center of the depression on the roller and determines the lateral position of the roller bracket on the turret (fig. 54).

(13) Cut and grind brackets to suit template pattern and turret surface.

(14) Weld the brackets to the turret.

**e. Mounting the Launcher.**

(1) Screw the nuts onto the trunnion pin brackets and onto the fixed pins of latch plates.

(2) Swing the hinged pins of latch plates forward against rear

## INSTALLATION OF LAUNCHER

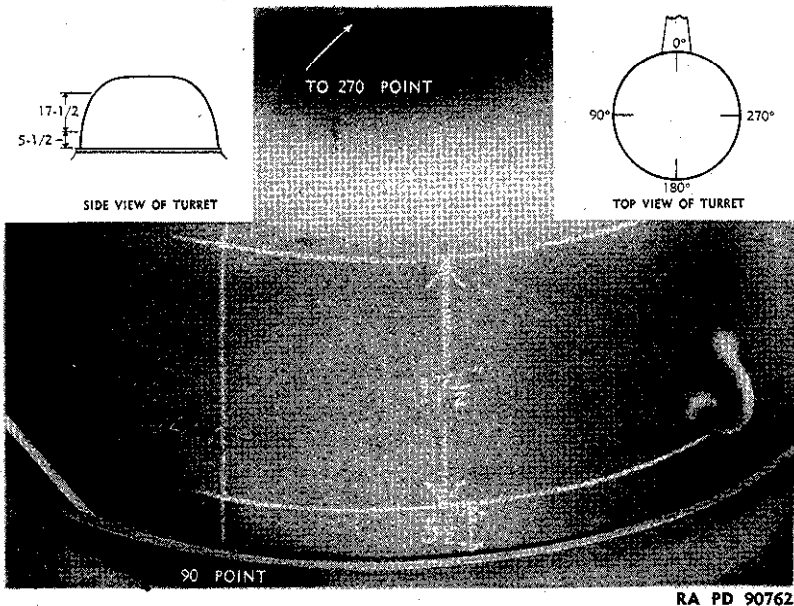

**Figure 53—Dimensions for Welding Jettison Roller Brackets**

sides of trunnion supports and engage with lower jettisoning latches. Clamp the hinged and fixed pins in this position, using "C" clamps.

(3) Elevate the gun and launcher until the crossheads at rear of equilibrator springs can be inserted into clevis openings, and engage the upper jettisoning latches.

(4) Drive in the pins to secure the nuts on elevating trunnions, on fixed pins of latch plates, and on trunnion pin brackets.

(5) Remove the "C" clamps.

(6) Set the launcher at zero elevation.

(7) Connect the link on the elevating strut to the receiver arm. If holes in screw fitting and receiver arm do not aline, adjust by means of screw fitting and adjusting nut (fig. 12).

f. **Installation of Electric and Hydraulic Lines.** Proceed as in paragraph 21 g.

g. **Filling of Hydraulic Systems for Jettisoning.** Proceed as in paragraph 21 h.

h. **Filling of Hydraulic Systems for Operation of Doors.** Proceed as in paragraph 21 i.

i. **Adjustment of Links.** Proceed as in paragraph 21 j.

7.2-INCH MULTIPLE ROCKET LAUNCHER M17

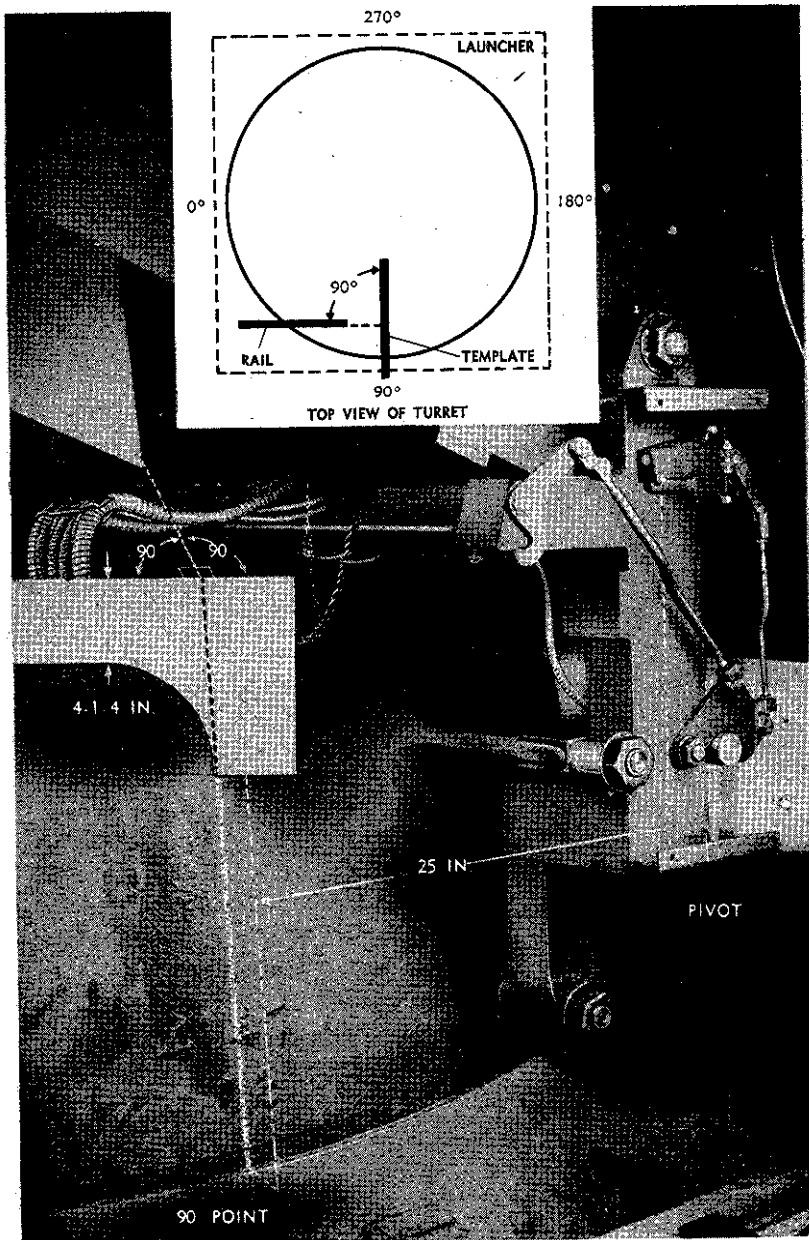

RA PD 90763

Figure 54—Horizontal Center Lines of Trunnion Pin Brackets and Latch Plates

**Section VII**  
**REFERENCES**

**23. PUBLICATIONS INDEXES.**

The following publications indexes should be consulted frequently for latest changes or revisions of references given in this section and for new publications relating to materiel covered in this manual:

- a. Introduction to Ordnance Catalog (explaining SNL system) ..... ASF Cat.  
ORD 1 IOC
- b. Index (index to SNL's) ..... ASF Cat.  
ORD 2 OPSI
- c. Index to Ordnance Publications (listing FM's, TM's, TC's, and TB's of interest to ordnance personnel, OPSR, FSMWO's, BSD, S of SR's, OSSC's, and OFSB's, and including alphabetical listing of ordnance major items with publications pertaining thereto) ..... OFSB 1-1
- d. List of Publications for Training (listing MR's, MTP's, FM's, TM's, TR's, TB's, MWO's, SB's, WDLO's, and FT's) ..... FM 21-6
- e. List of Training Films, Film Strips, and Film Bulletins (listing TF's, FS's, and FB's by serial number and subject) ..... FM 21-7
- f. Military Training Aids (listing graphic training aids, models, devices, and displays) ..... FM 21-8

**24. STANDARD NOMENCLATURE LISTS.**

- a. Cleaning, preserving, and lubricating materials; recoil fluids, special oils, and miscellaneous related items ..... ORD 5  
SNL K-1
- b. Rockets, all types and components ..... ORD 11  
SNL S-9
- c. Soldering, brazing and welding material, gases, and related items ..... SNL K-2

**7.2-INCH MULTIPLE ROCKET LAUNCHER M17****25. EXPLANATORY PUBLICATIONS.**

- a. Ammunition, general ..... **TM 9-1900**
- b. Cleaning, preserving, lubricating, and welding materials and similar items issued by the Ordnance Department ..... **TM 9-850**
- c. Decontamination ..... **TM 3-220**
- d. Defense against chemical attack ..... **FM 21-40**
- e. Medium tank M4A2 ..... **TM 9-731B**
- f. Medium tank M4A3 ..... **TM 9-759**
- g. Medium tank M4A4 ..... **TM 9-754**
- h. Medium tanks M4 and M4A1 ..... **TM 9-731A**
- i. Qualifications in arms and ammunition training allowances ..... **AR 775-10**
- j. Range regulations for firing ammunition for training and target practice ..... **AR 750-10**

