

Astron

Nighthawk

PARTS LIST

- (A) 1 Balsa Nose Cone - Part #BNC-20B
- (B) 1 Body Tube - Part #BT-20R
- (C) 2 Sheets Balsa Fin Stock - Part #BFS-40L
- (D) 1 Sheet Balsa Fin Stock - Part #BFS-40
- (E) 1 Sheet Balsa Fin Stock - Part #BFS-20D
- (F) 1 1" X 1/8" Maple Dowel - Part #WD-1A
- (G) 1 Screw Eye - Part #SE-1
- (H) 1 Engine Holder Strap - Part #EH-2
- (I) 1 Shock Cord - Part #SC-1
- (J) 1 12" Parachute - Part #PK-12A
- (K) 1 Launching Lug - Part #LL-2B
- (L) 1 Strip Lead Trim Weight - Part #NCW-3
- (M) 1 Aluminum Hinge Material (1" X 1") - Part #AH-1
- (N) 1 Pattern and Template Sheet - Part #SP-34
- (O) 72" Shroud Line Material - Part #SLT-12
- (P) 6 Tape Strips - Part #TD-2F

In addition to the parts listed above you will need the following tools and supplies:

- 1) Modeling knife or single-edged razor blade.
- 2) Metal-edged ruler or equivalent.
- 3) Cardboard or magazine for cutting surface.
- 4) Scissors, medium, fine and extra fine sandpaper.
- 5) A 1" by 1" by 4" block of pine - smooth and flat on at least one side.

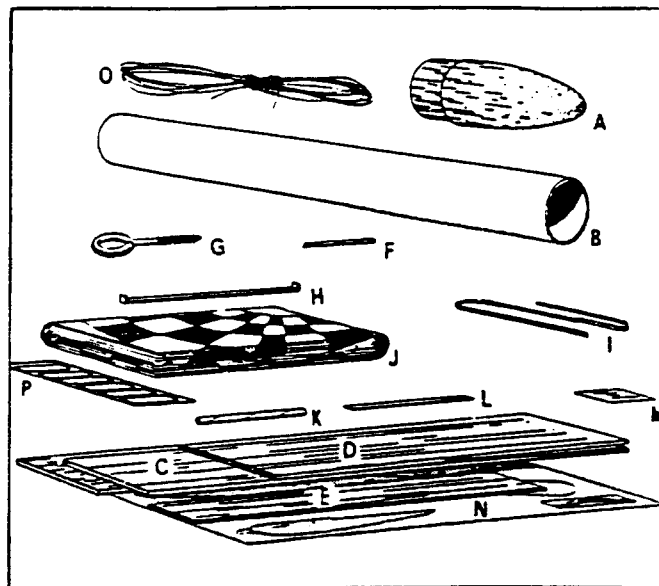

- 6) Extra strong white glue, white and colored paint or dope and sanding sealer.

BEGIN CONSTRUCTION OF

Nighthawk

1. Cut all the templates for wood parts from the pattern sheet. Lay out three parts on each piece of BFS-40L as shown. Cut out the parts. Lay out four of the canard pattern on the sheet of BFS-20D. Pylon parts are laid out on the short BFS-40.

2. Pin the two body section pieces together and sand them to shape as shown above. Use fine and extra fine sandpaper to do this. When smooth, apply the first coat of sanding sealer, covering all but the wing "land" as shown.

3. Remove the pins and separate the two body section parts. Hollow out the areas marked for the ballast weight and pin receiver to a depth of about 3/64" for the ballast weight and 1/16" for the pin receiver. Do this to both body sections so that when rejoined, each hollowed area faces and matches the other. Join the two sides together with white glue and tape as necessary to clamp both pieces together until the glue has set. You should have a slot for the weight measuring 3/4" long by 3/32" wide by 1/4" deep and a pin receiver socket about 5/32" in diameter and just over 1/2" deep.

4. At this point in construction, the only sanding done on the wings is to bevel the root edges of each wing panel. Join the wing panels as shown in the figure above. Tape one panel to a flat surface. Apply glue to the root edge of the other panel and place against the root edge of the first one. Hold the second panel at the approximate angle of dihedral and slide the dihedral template into position as shown. The edges should be flush against the surfaces for which they are labeled.

5. The tip panel can be cut off and glued back on at the correct angle. However, it is easier to cut a "V" notch across the balsa and bend the wood. Cutting the "V" is easier than it looks. Use a sharp knife, a straight edge and care to cut it in. Allow the other panel to extend beyond the edge of the table. Tape down the panel on which you are about to cut, and make sure your blade has a good edge and proceed to step 6.

BFS-40L PARTS LAYOUT - STEP 1 TYPICAL LAYOUT FOR EACH SHEET



THE PYLON PIECES ARE LAID OUT ALONG ONE EDGE OF THE BFS-40 18" LONG SHEET. SAVE THE REMAINDER OF THE SHEET FOR MAKING ADDITIONAL PYLON AND BODY PIECES IF NEEDED.

RESULTS OF SANDING - STEP 2

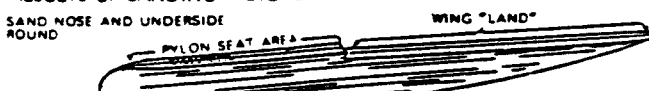

CARVING THE RECESSES - STEP 3



JOINING WING PANELS - STEP 4

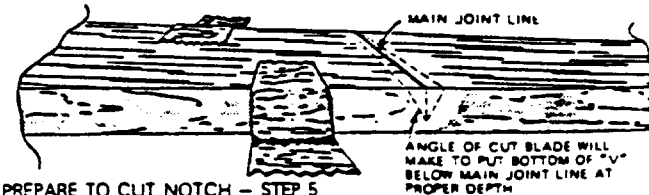

DIHEDRAL ANGLE TEMPLATE

TO FLAT SURFACE

TIP PANEL ANGLE TEMPLATE

MAIN WING

TIP PANEL

CANARD SURFACE TEMPLATE

STATIC HALF

GRAIN

LEADING EDGE

ROOT EDGE

DOTTED LINE INDICATES WHERE THE FOUR HALF CANARD PIECES MUST BE CUT AFTER SANDING IS COMPLETED

CONTROL HALF

HINGE LAYS WITHIN THIS AREA

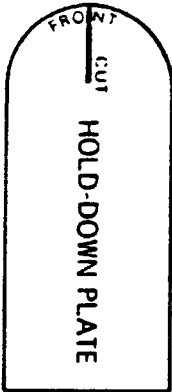
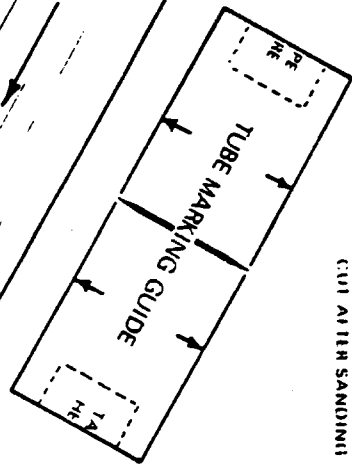

A SUBSIDIARY OF DAVON
ESTES INDUSTRIES
 4001 207th AVENUE, GLEN, COLORADO, 80540

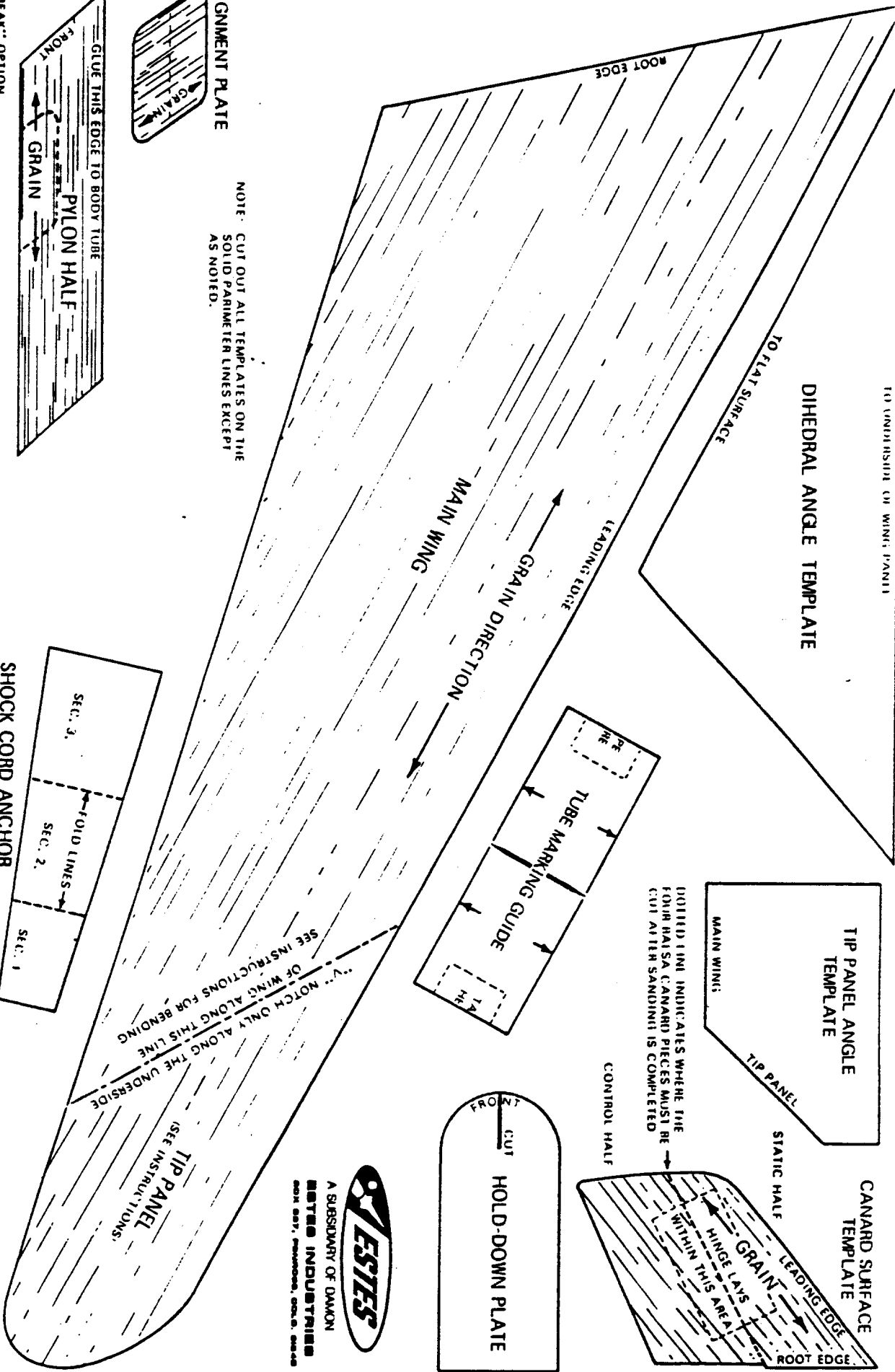

NOTE: CUT OUT ALL TEMPLATES ON THE SOLID PARAMETER LINES EXCEPT AS NOTED.

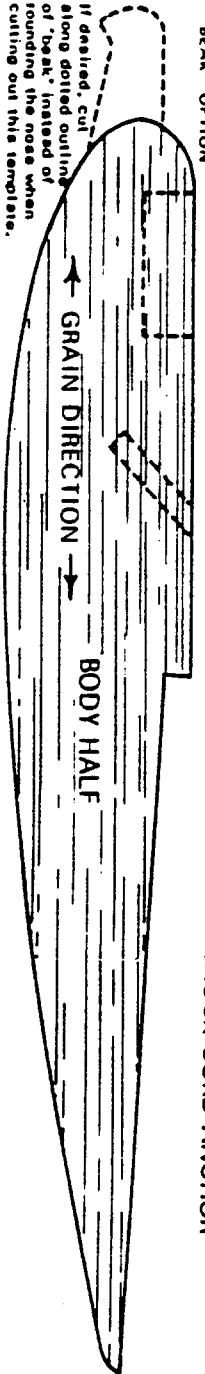
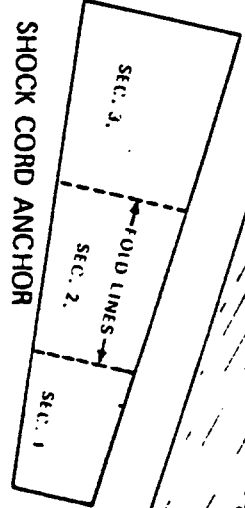
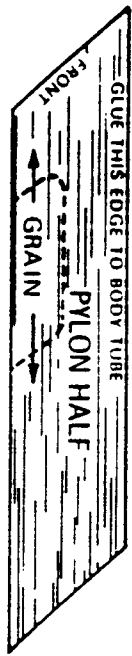

"BEAK" OPTION

If desired, cut along dotted outline of "beak" instead of rounding the nose when cutting out this template.

SP - 34
 ASTRON NIGHT HAWK
 PATTERN SHEET
 PART M OF KIT NO. K-34

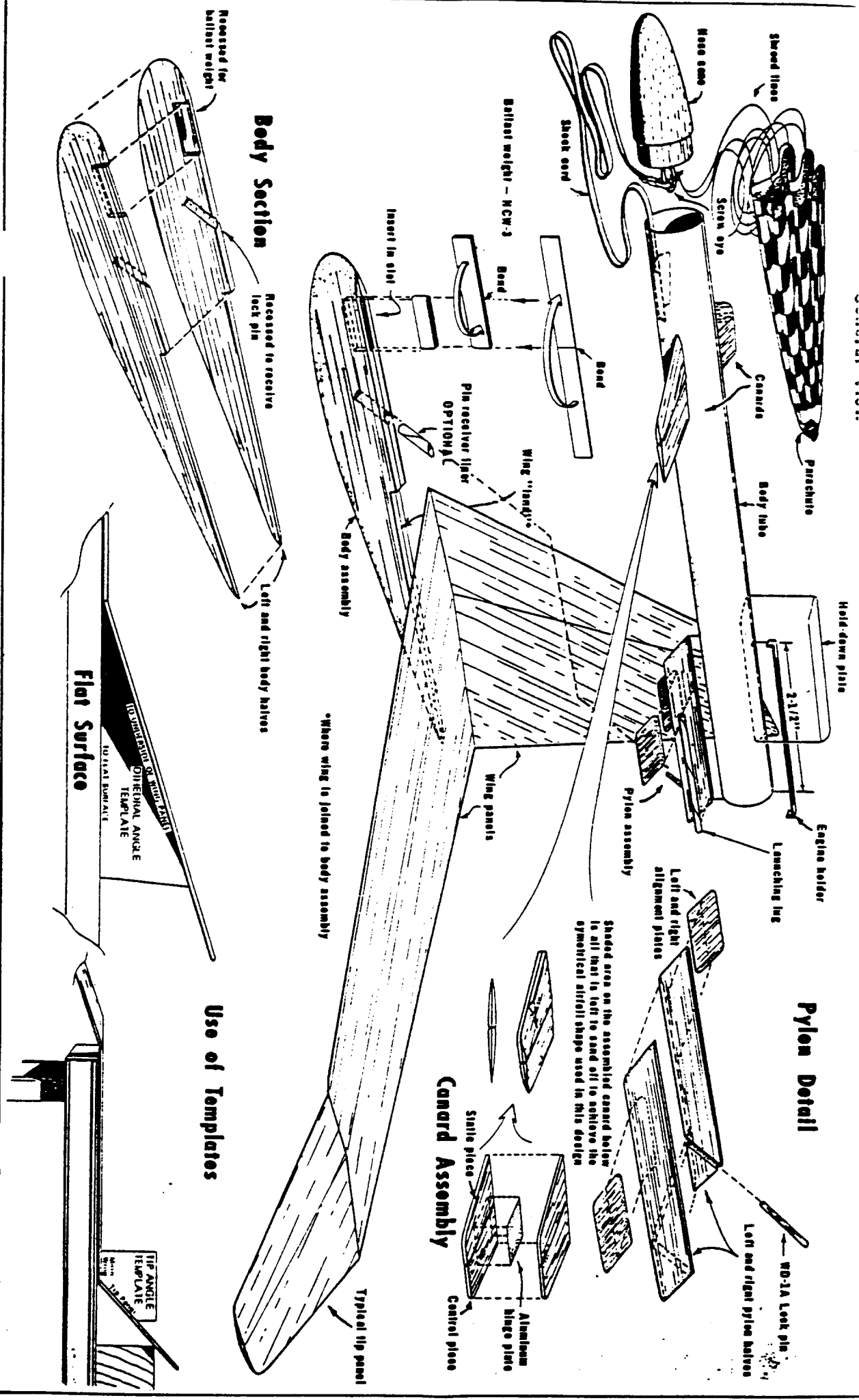

Pylon Detail

Body Section

Use of Templates

Flat Surface



CUTTING THE NOTCH - STEP 6

SEQUENCE OF DRAWINGS SHOW HOW BLADE ANGLE REMAINS THE SAME



ON EITHER SIDE AS THE CUTS ARE DEEPENED

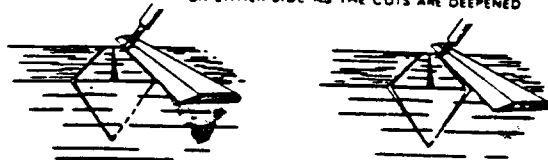

AND FINALLY AS THE WASTE AREA IS LOOSENED AND REMOVED

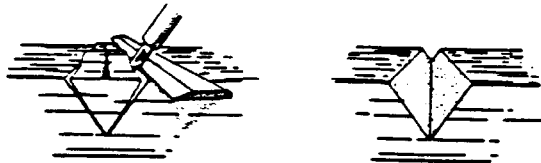

BEND & GLUE TIP PANEL - STEP 7

APPLY GLUE LIBERALLY



DO NOT ALLOW GLUE TO RUN OUT THE ENDS OF THE NOTCH

AFTER ABOUT 3 MINUTES . . .



SOME GLUE WILL HAVE SOAKED INTO THE WOOD SOFTENING AND MAKING IT PLIABLE

HOLD DOWN MAIN PANEL HERE . . .



. . . WHILE GENTLY LIFTING HERE

SPREAD SQUEEZED OUT GLUE INTO A FILLET

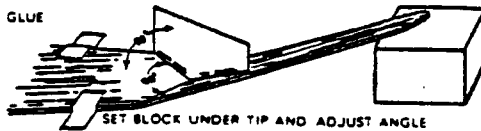

SET BLOCK UNDER TIP AND ADJUST ANGLE TILL CORRECT AS DETAILED IN STEP 7 TEXT

ATTACH BODY - STEP 8

FRONT VIEW

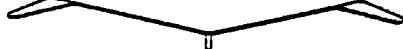

APPLY GLUE TO WING LAND



SIDE VIEW



SAND IN THE AIRFOIL - STEPS 9 & 10

ILLUSTRATED IS THE TOPSIDE LEFT WING READ STEP 9 TEXT CAREFULLY

SAND CROSS-GRAIN FOR QUICKER REMOVAL OF BALSA

SANDPAPER AROUND BLOCK

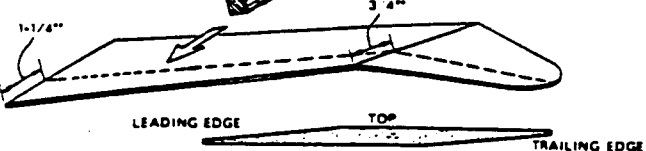

LEADING EDGE

TOP

TRAILING EDGE

TYPICAL CROSS-SECTION OF AIRFOIL AT ABOUT MID-SPAN

MARK THE BOOSTER TUBE - STEP 12

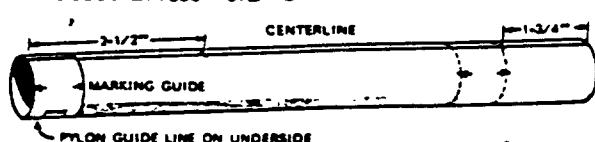

MARKING GUIDE

PYLON GUIDE LINE ON UNDERSIDE

6. The depth of the notch may vary slightly. Try to make the bottom of the "V" about 3/4 of the way through the panel from the underside. Do this by placing the straight edge parallel to the line and about 1/16" away from it. Hold your knife at such angle that the point of the blade will be directly under the line about 3/4 of the way through the panel. Do not try to cut all the way with the first slice - take your time and make several passes making sure you do not vary the blade angle. Repeat this portion of the step for the other side of the notch. When your blade reaches near the bottom of the "V" portions of the waste wood will appear loosened. This is your signal to take it easy and cut carefully the remaining fibers to free the waste and clean out the notch. Repeat the entire step with the remaining panel. Leave this panel in place and go on to the next step.

7. Fill the notch with white glue from leading edge to trailing edge and allow it to soak in for about 3 minutes. Now, GENTLY, begin bending the tip panel to the correct angle. Hold the main panel near the notch with one hand while lifting the tip panel by its tip with the other hand. Once a 45 degree angle has been achieved, block the tip panel in this position. Glue will have squeezed out along the notch during this action - smooth it into a fillet all the way along the notch. Establish the exact angle using the tip angle template as shown. Note that the tip angle is correct when that part of the template marked "Main Wing" is flush with the wing surface and the tip panel surface is against the "Tip Panel" edge of the template. Once the correct angle is established, do not disturb the wing until the joint is completely dry. Repeat the step with the other wing and tip panel.

8. Apply glue to the wing land area of the body section and set the wing in place. Align the wing and body section as shown and set aside to dry.

9. Sand in the airfoil next. Measure back from the leading edge on the topside of the wing at the center and mark at 1-1/4". Measure back from the leading edge, along the joint between wing and tip panel and mark at 3/4". Join these two marks with a dotted line, using a straightedge. Move the straightedge to the tip panel, and extend the dotted line (now PARALLEL to the leading edge) to the extreme tip of the panel. Repeat this step with the other wing and tip panel. Repeat the entire step on the underside of the wing and tip using the same measurements EXCEPT MEASURE AND MARK FROM THE TRAILING EDGE, FORWARD.

10. Use medium sandpaper on a block and sand the top side of the wings and tips first. Sand cross-grain from the leading edge back to the dotted line. Sand until you have achieved a leading edge thickness of just less than 1/16" with a smooth flat taper back to the dotted line, for the entire length of the wing and panels. Now repeat the step, sanding the underside trailing edge of the wings and tips. Work for a smooth flat taper from 1/8" thick at the dotted line back to 1/16" thick at the trailing edge. When all panels have been "roughed in" as above, use fine sandpaper to sand with the grain to achieve a smooth surface and rounded leading and trailing edges. The illustration shows a typical cross-section of the wing at about mid-span.

11. Apply sanding sealer to the entire bird (keeping the pin receiver hole and ballast slot clear of sealer) and allow to dry. Fine sand, seal, sand and seal again to obtain the base surface for the paint job of your choice.

Flying note: As with all boost gliders, this bird flies longest if only enough paint is applied for good visibility. Use fluorescent red-orange or other high-visibility color to keep those long hops in sight.

BOOSTER ASSEMBLY

12. Cut the tube marking guide from the pattern sheet and wrap it around the tube. Secure the ends of the guide together with tape as shown. Slide the guide to one end of the tube and mark the tube at the guide joint and at the heavy line (one is 180 degrees from the other). Extend one mark for the full length of the tube. Extend the other mark about 3". The long line will be the tube centerline and the short line the pylon guide line. Measure and mark a point on the centerline 2-1/2" from the end which has the pylon guide line, and another point 1-3/4" in from the opposite end, also on the centerline. Slide the tube marking guide up to the 1-3/4"

mark, realign the heavy line on the guide with the centerline and mark the tube at each arrow point on the guide (found at either side of the heavy line). Slide the guide off the tube and with a straightedge, connect each pair of marks with a straight line.

13. Carve the two halves of the pylon as shown for the pin seat. Lay the pin on one side and check the fit of the other side over it. When both halves fit together tightly around the pin the assembly is ready to be glued. Apply glue to the inside surface of one half of the pylon, including the pin slot. Lay the pin in place and position the remaining pylon half over the first one. Align the assembly carefully and hold together with tape until dry. Wipe off any excess glue which squeezes from between the halves or from around the pin.

14. Apply glue to the inside top half of an alignment plate and position it on the side of the pylon in the area shown in the close-up pylon assembly drawing. Repeat with the other alignment plate.

15. Apply glue to the top edge of the pylon assembly and place it against the BT-20B body tube directly over the pylon guide line as shown. Be sure the pylon sticks straight out from the tube center as viewed from the end and is parallel to the tube centerline.

16. Run a line of glue down one side of the LL-2B launching lug and attach it to the tube-eyon joint on the left side.

INSTALL THE RECOVERY SYSTEM

17. Cut the shock cord anchor from the pattern sheet. Attach the shock cord to it as shown. Glue the shock cord anchor into the front end of the body tube at a depth of at least 3/4" to allow the nose cone to be completely seated.

18. Turn the screw eye into the base of the nose cone. Remove it and squirt glue into the hole. Replace the screw eye and wipe off any excess glue from around the shank of the eye.

19. Cut out the parachute on its edge lines as indicated on the plastic. Cut six 12" lengths of shroud line cord and attach one shroud line to each point of the parachute with a tape strip as shown above. Gather and tie the free ends of the shroud lines together. At this point you may tie the shroud lines to the screw eye in the base of the nose cone - also tie on the free end of the shock cord.

FORM AND ATTACH CANARDS

20. Cut the canard pattern from the pattern sheet and lay out four pieces on the BFS-20 sheet as shown. Cut them out and then make the final cut of each one separately, using a straightedge to guide your blade in this slightly cross-grain cut. When this step is complete, you will have 4 static pieces and 4 control pieces.

21. Cut the metal sheet in half with ordinary scissors - select one piece and "rough it up" as shown. A few passes with medium sandpaper or the point of a scribe or compass will do - this will give the surface "tooth" and give a much better glue bond. Repeat this step with the other piece.

22. Select 1 static and 1 control piece prepared in step 20. Place them as shown and apply glue to the roughed areas on one side of a metal sheet. Lay the metal sheet across the slot between the static and control piece (glued side down) so that its surface area is equally divided. Apply glue to the proper side of another static piece and align it carefully over the first one. Wipe off any glue that squeezes out onto the remaining part of the metal sheet that is exposed. Apply glue to another control piece (on the proper side) and align it carefully over the first. Locate a flat surface and a heavy flat-bottomed object. Place this assembly on the flat surface, then place the object on top being careful not to move any part of this lamination. Repeat steps 21 and 22 to form the second canard unit. Allow both units to dry completely before proceeding.

23. Use fine sandpaper on a block to sand each canard surface into a symmetrical airfoil as seen on the large panel. It may be necessary to open up the joint between the static and control surface - if so, this can be done with the edge of a piece of sandpaper (sanding side toward the control surface) drawn carefully along the seam.

24. Apply glue to the root edge of the static part of one canard unit. Locate it on one of the lines drawn in step 12. Align the canard unit so it sticks straight away from the body tube center and is parallel to the body tube centerline. Repeat this step with the other canard unit.

BASIC PYLON - STEP 13

CARVE RECESS FOR LOCK PIN SAME WAY AS IN STEP 2 - EXCEPT THIS IS A TIGHT FIT AROUND PIN

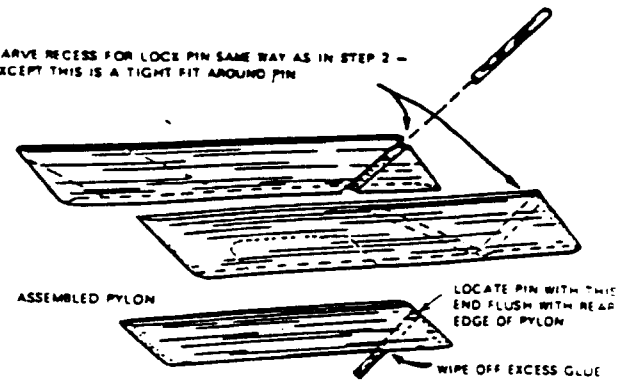

ALIGNMENT PLATES - STEP 14

LOCATE ALIGNMENT PLATES THIS AREA ON EACH SIDE OF PYLON

GLUE APPLIED TO SHADED AREA INSIDE EDGE

ATTACH PYLON & LAUNCHING LUG - STEPS 15 & 16

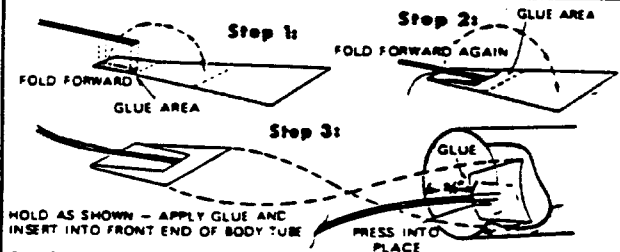
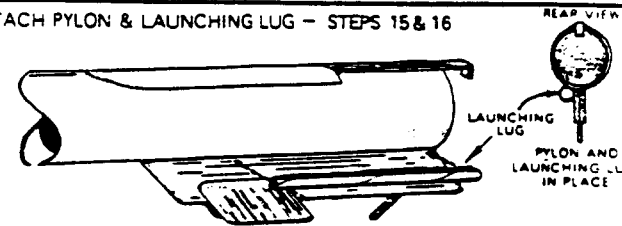

SHOCK CORD ANCHOR - STEP 17

MOUNT THE SCREW EYE - STEP 18

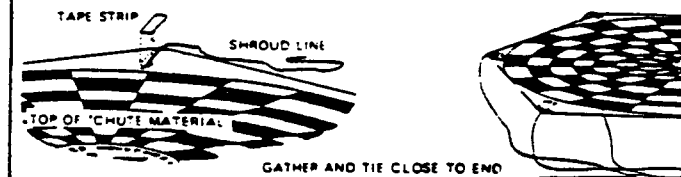
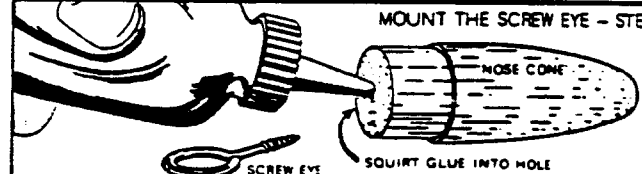

PARACHUTE - STEP 19

CANARD CONSTRUCTION - STEPS 20-24

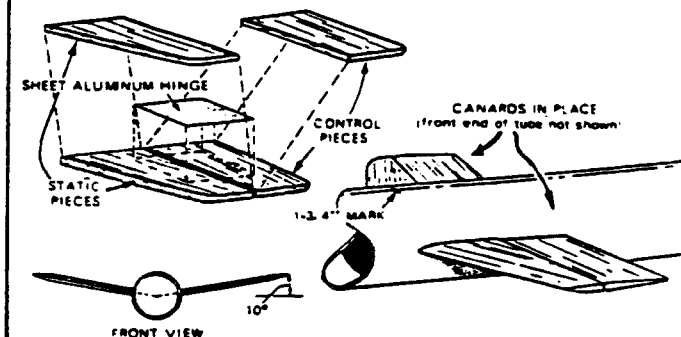

PREPARE TRIM WEIGHT—STEP 26

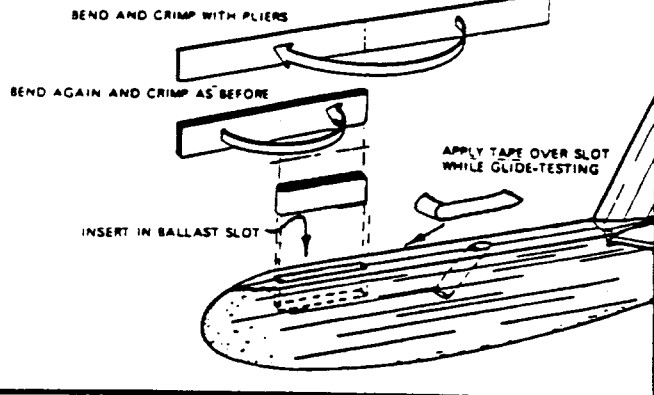

GLIDE ADJUSTMENT—STEP 27

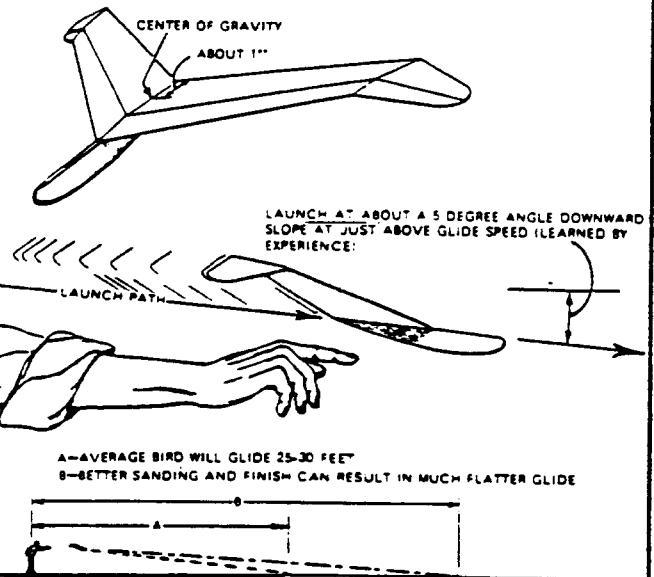

TIP ANGLE MAY BE ADJUSTED TO REMOVE SEVERE TURN

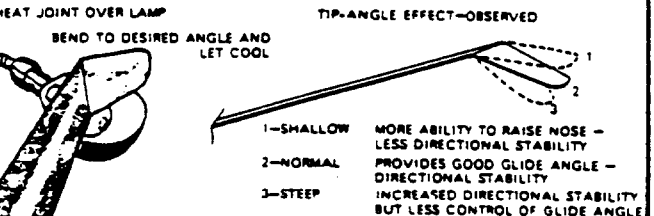

FITTING THE BOOSTER—STEP 28

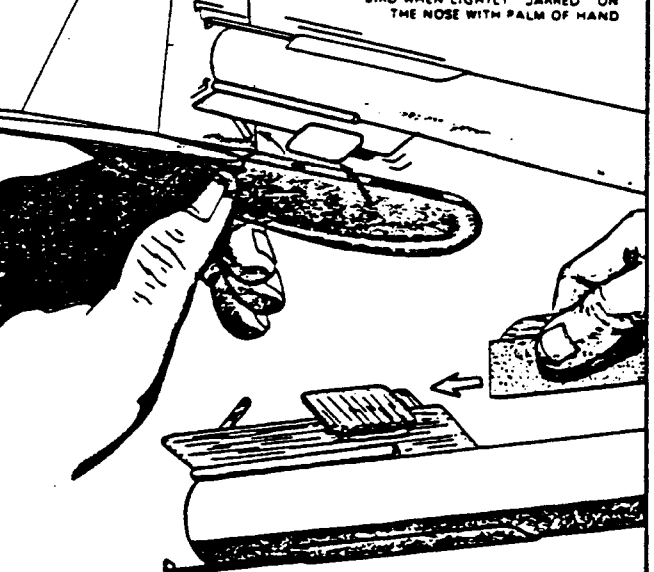

2 PIECES BFS-40 SCRAP WRAPPED WITH EXTRA FINE SANDPAPER ARE PASSED BETWEEN ALIGNMENT PLATES TO WIDEN AND SMOOTH THE "SADDLE"

25. Apply sanding sealer to all balsa parts of the booster unit. Let dry, sand, and apply sealer again. Repeat this until the surface is smooth and the pores in the wood are filled. Apply a base coat of white enamel followed by the color coat of your choice. See Flying Note; step 11. After all colors have been applied and allowed to dry at least 24 hours, two items will remain to be done before your bird is ready for powered flight.

BALANCE AND GLIDE TESTING

26. Bend the NCW-3 strip weight exactly in half and crimp the bend with pliers. Bend the doubled weight exactly in half and again crimp the bend. Your weight should now look like that shown in the large panel illustration. Insert the weight into the ballast slot and for now apply a strip of tape just large enough to hold the weight in place during test glides. (When the bird has been balanced the weight of the tape is replaced by securing the ballast with white glue.)

27. The balance point should be about 1" from the trailing edge of the wing at the center joint of the wing when the weight is installed. Glide from about shoulder height and make a smooth, slightly nose-down toss into any breeze present. (Ideally, test-gliding should be made in perfectly calm air.) The bird should glide straight with no more than a gentle turn, landing some 25 to 30 feet away. Further weight adjustment, better sanding and finish can obtain a glide of nearly fifty feet when launched from shoulder height. Should test-gliding indicate a severe turn in either direction, recheck the angle of the tip panels. This angle may be adjusted by holding the joint area close to a 60 to 100 watt lamp until the glue becomes pliable. Gently bend the tip to the desired position and hold it there until the joint cools.

NOTE: The amount of weight and the glide expectations mentioned above are based on the airfoil and finish obtained from following steps 9, 10 and 11. Different airfoils may mean that little or no weight need be used — the C/G will be in a different location. Save your templates and after gaining more experience with this design, try some experiments with different airfoils and compare your results.

28. Fit the booster "saddle" to the glider. You should be able to "pop" the booster unit off the bird with the palm of your hand applied to the nose cone with very light force. Paint overspray etc., can make the saddle fit too tight. If so, wrap a piece of extra fine sandpaper around two thicknesses of scrap BFS-40 (simulating the bird's body thickness) and sand the inside surfaces of the alignment plates only. Sand a little and try the fit — repeat as necessary to get that "just right" fit.

USE OF CANARDS

Because boost-glide vehicles are very sensitive to trim in their upward flight as well as glide, few rocketeers are able to achieve a consistent perfect vertical flight. More often, the model will rise in a wide curve and will be travelling horizontally by the time ejection occurs.

To compensate for these variations in trim, your Nighthawk boost pod is equipped with adjustable canards. By setting the canards to the recommended position initially and adjusting them according to the results observed when flying the model, it is possible to achieve an excellent upward flight.

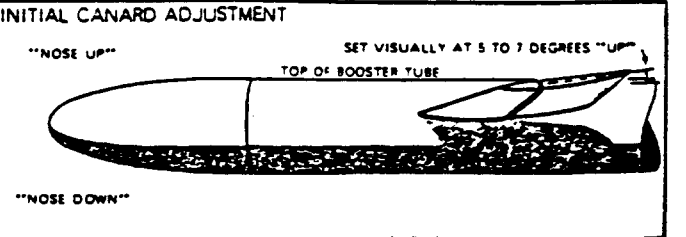

For your first flight, set the canards to the position shown in the special illustration above. If the model tends to "nose down" in flight, bend the flaps down very slightly (no more than 1/32"). If the model "noses up", bend the flaps up slightly. Test fly again and adjust the flaps as necessary.

PACKING THE 'CHUTE - STEP 12

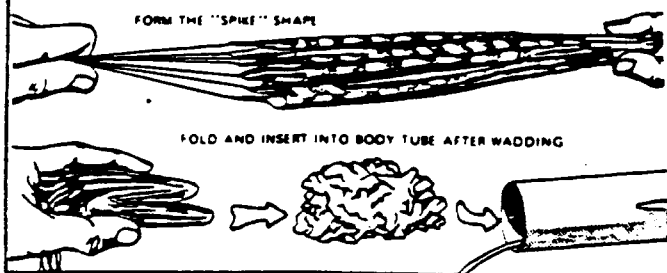

- 12. Pack flame-resistant recovery wadding into the booster tube from the top. The wadding should fill the tube for a distance of about 1-1/2" and give a good seal along the sides of the tube. Hold the parachute between two fingers at its center and pass the other hand down it to form a "spike" shape. Fold this spike in two or three sections and push down into the tube on top of the wadding. Pack in the shroud lines and shock cord on top of the 'chute and slide the nose cone into place.
- 11. Adjust the canard control surfaces to about 5 degrees "up" trim for the first flight. Close observation of the first flight will show whether more or less control angle is needed.
- 10. Select an engine. An engine such as the 1/2A6-2 may be used when adjusting glide characteristics. For longer flights an A5-2 is recommended. For all-out duration use the B4-2. Install an electrical igniter into the nozzle as directed in the instructions which came with the engine. Insert the engine into the rear of the booster until the rear hook of the engine holder snaps into place behind the rear edge of the engine casing.



A SUBSIDIARY OF DAMON

ESTES INDUSTRIES

BOX 227, PENROSE, COLO. 81240

LAUNCHING TIP - STEP 9

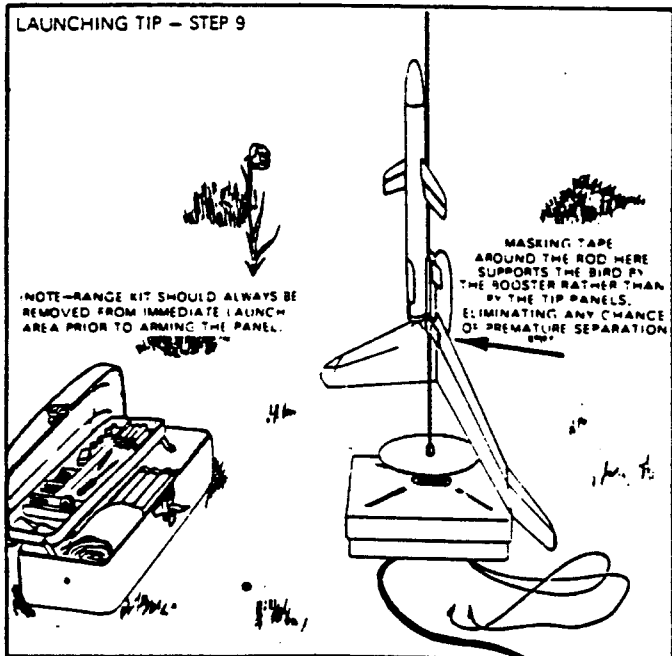

- 9. Place the booster on the launcher. (It helps to wrap a strip of masking tape around the launching rod about 6" up from the blast deflector so the model is held up by the booster rather than the glider's tip panels.) Check to be sure the panel is disarmed. Clean the micro-clips and attach them to the igniter leads. Slide the glider into place with the pin in the receiver on the bird and the nose area of the bird in place between the alignment plates on the booster pylon.
- 8. Clear the launch area, alert the recovery crew and the tracking crew.
- 7. Check for low flying aircraft and unauthorized persons in the recovery area.
- 6. Arm the launch panel and commence the final countdown.
- 5- -4- -3- -2- -1- LAUNCH!